

Integral Unit

Bar-Visibility Graphs

Therese Biedl Ahmad Biniiaz
Veronika Irvine Philipp Kindermann
Anurag Murty Naredla Alexi Turcotte



UNIVERSITY OF WATERLOO
FACULTY OF MATHEMATICS
David R. Cheriton School
of Computer Science

Bar-Visibility

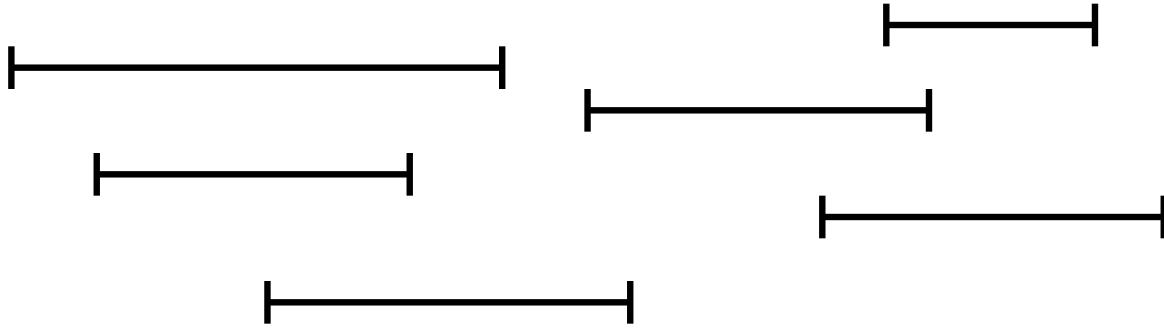

Bar-Visibility

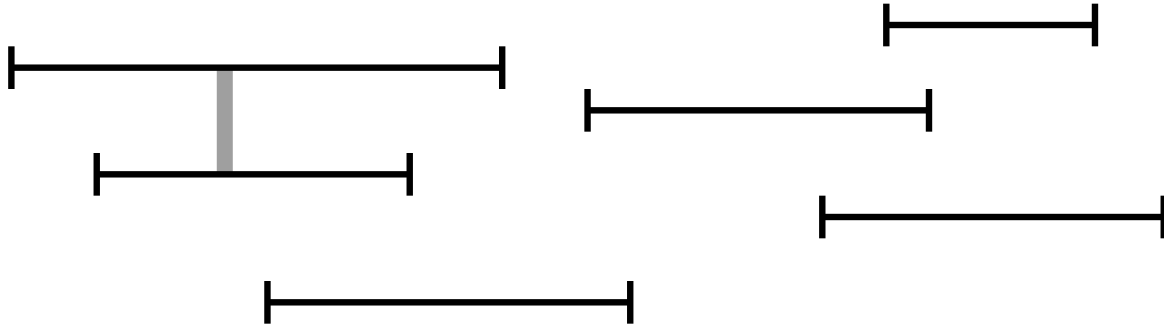

Bar-Visibility

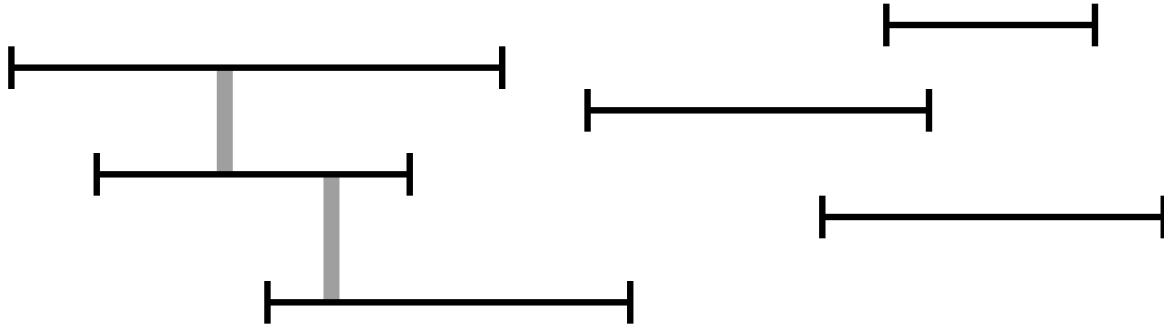

Bar-Visibility

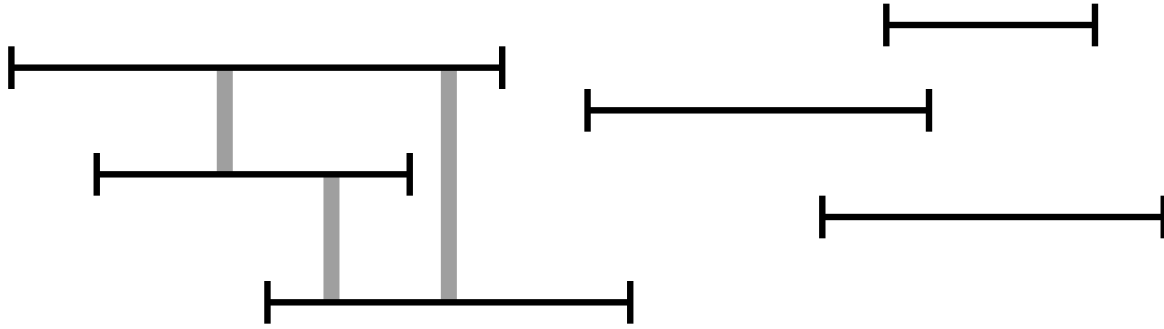

Bar-Visibility

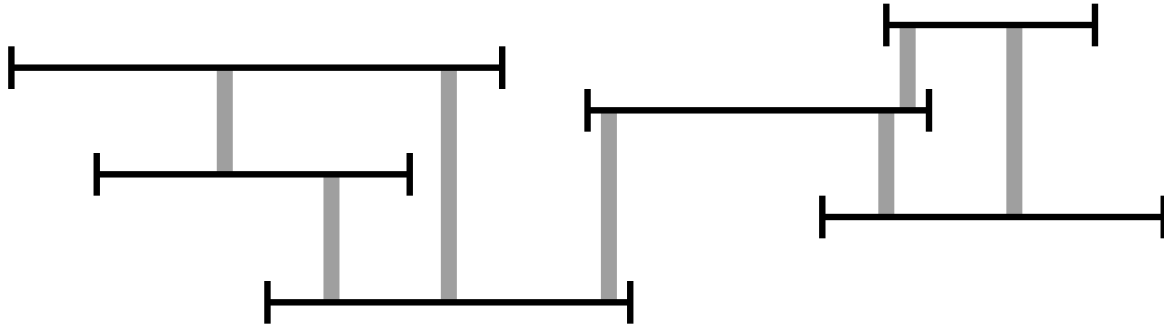

Bar-Visibility

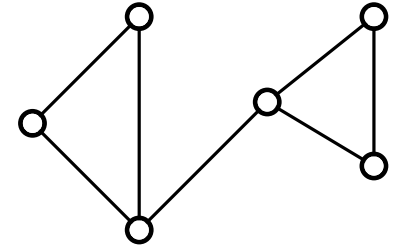
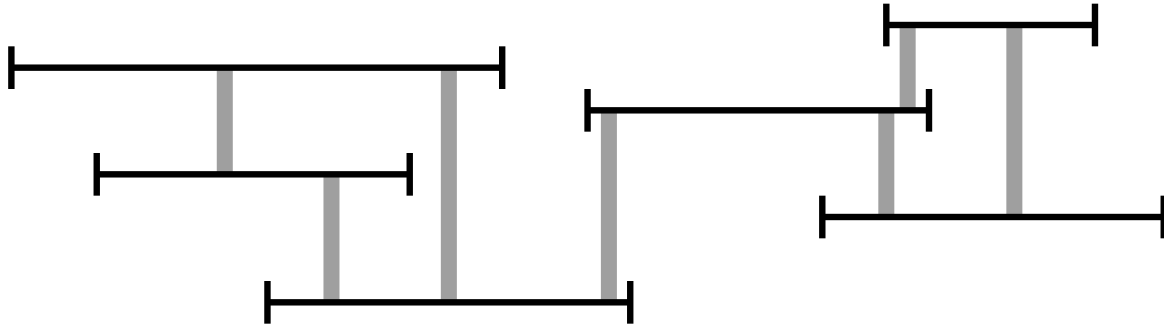

Bar-Visibility

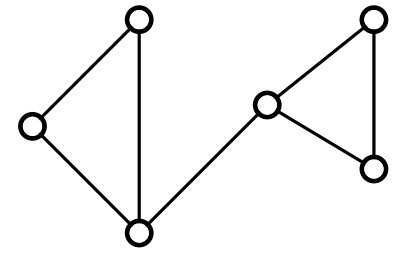
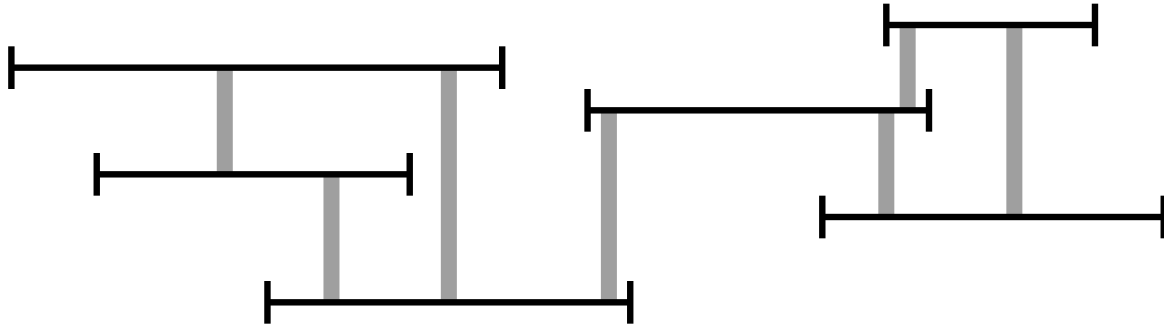

Strong

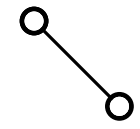

\Leftrightarrow

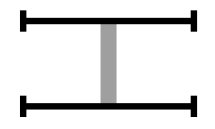

Bar-Visibility

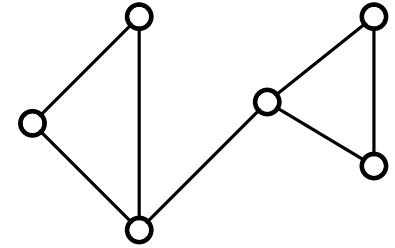
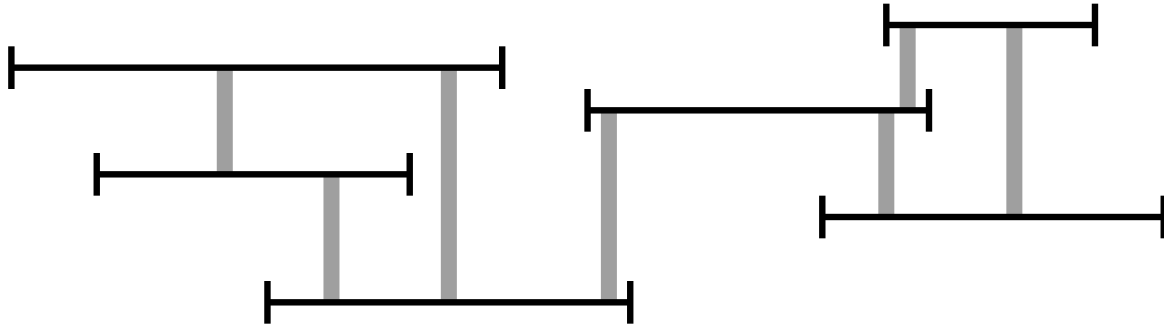

Weak

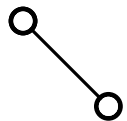

\Rightarrow

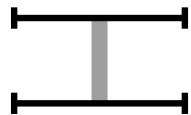

Strong

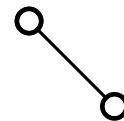

\Leftrightarrow



Bar-Visibility

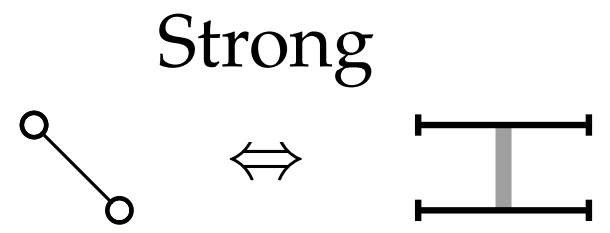
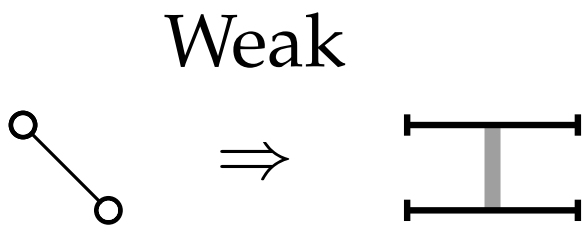
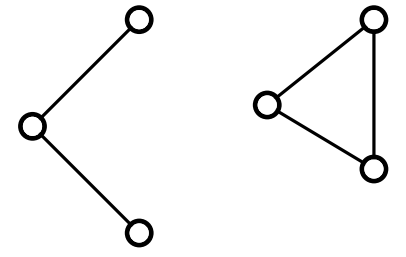
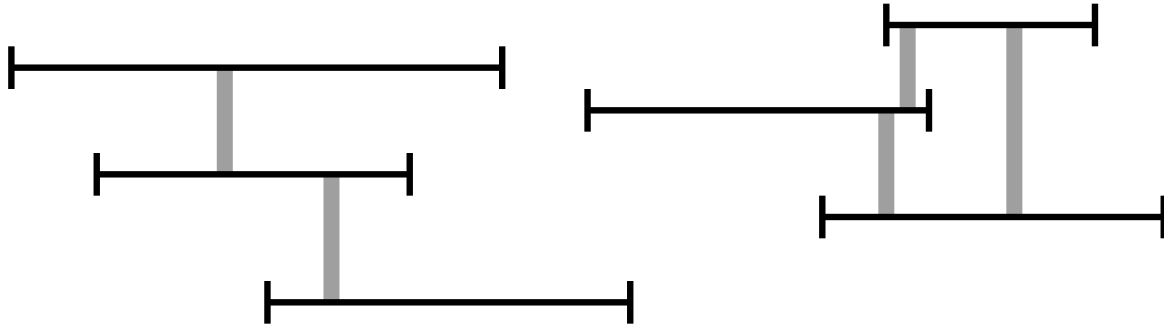

Bar-Visibility

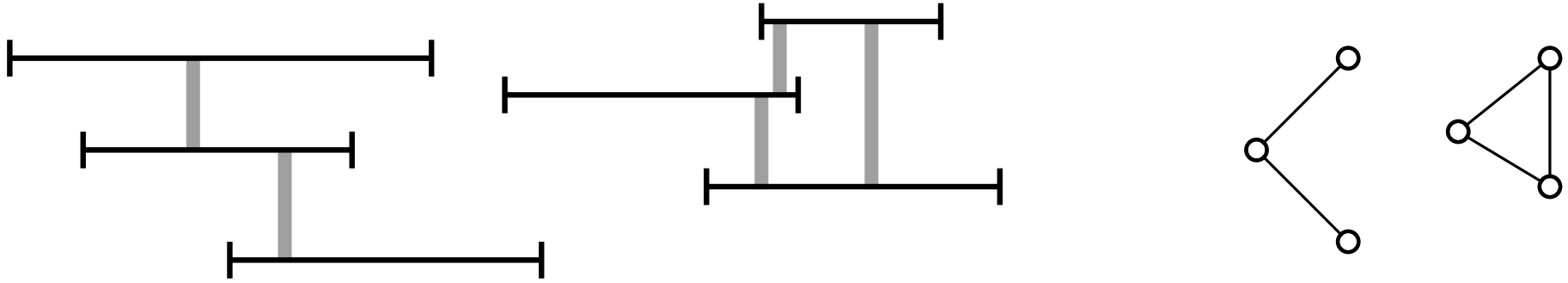

Every planar graph,
 $O(n)$ time

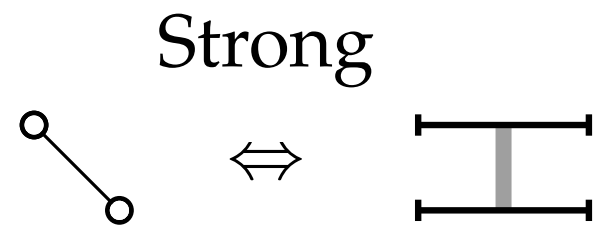
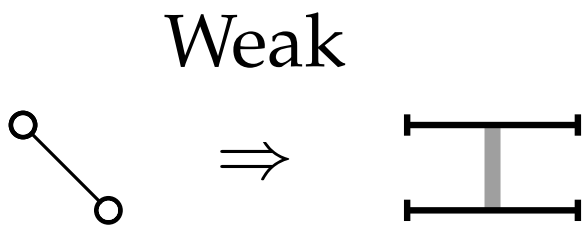

Bar-Visibility

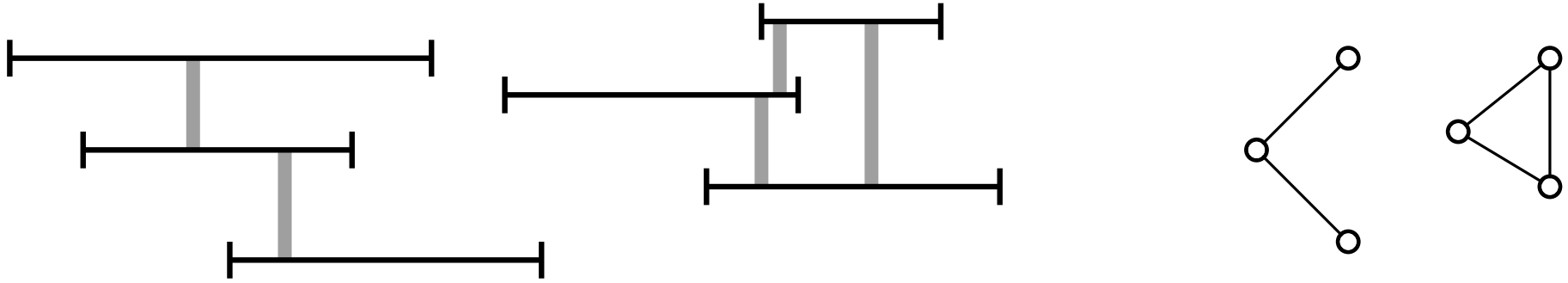

Every planar graph,
 $O(n)$ time

3-connected: NP-hard

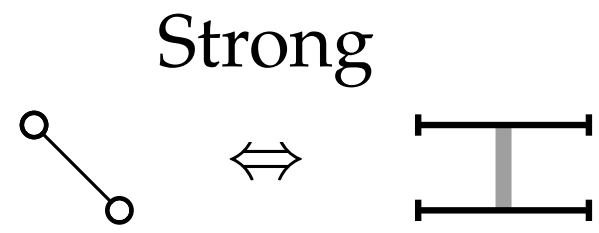
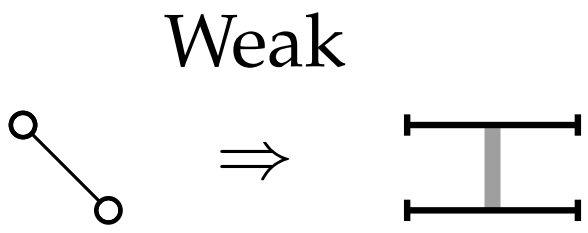

Bar-Visibility

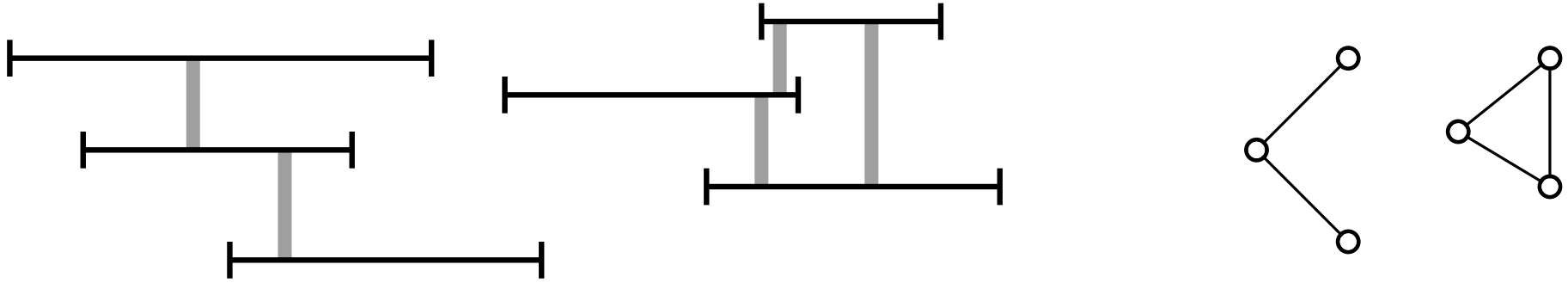

Every planar graph,
 $O(n)$ time

3-connected: NP-hard
Triangulation: $O(n)$ time

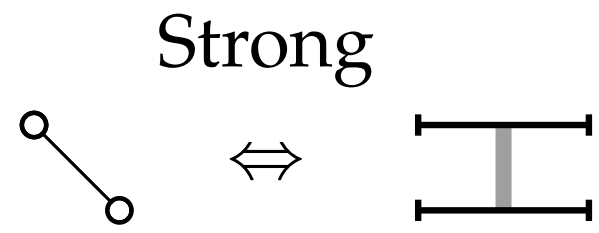
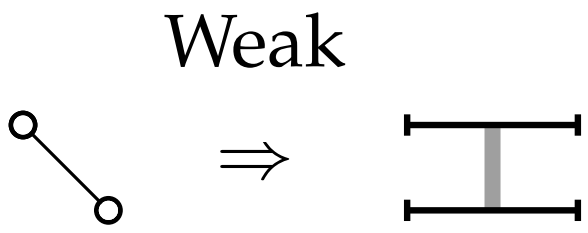

Bar-Visibility

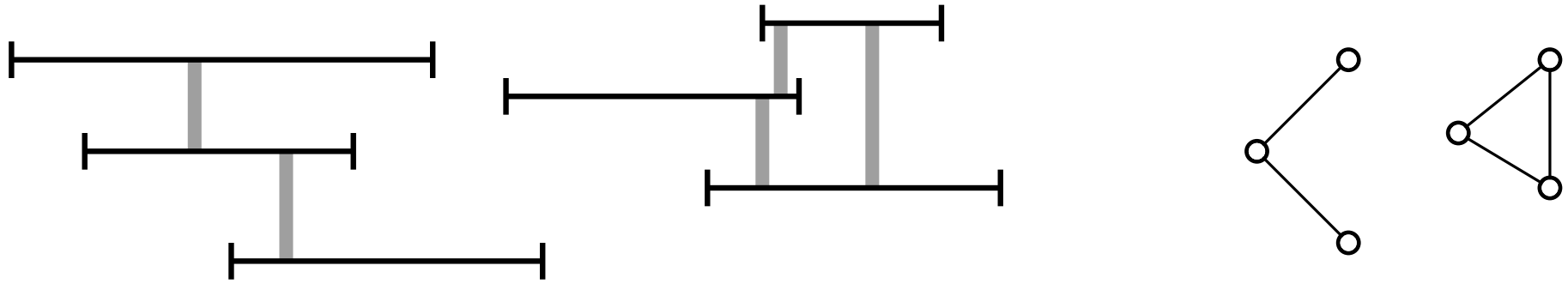

Every planar graph,
 $O(n)$ time

3-connected: NP-hard
Triangulation: $O(n)$ time
4-connected: $O(n)$ time

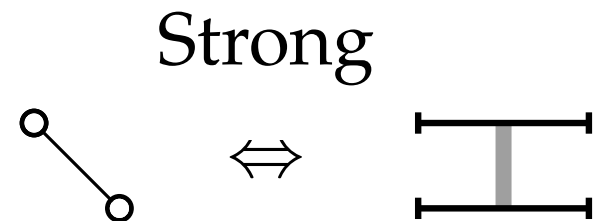
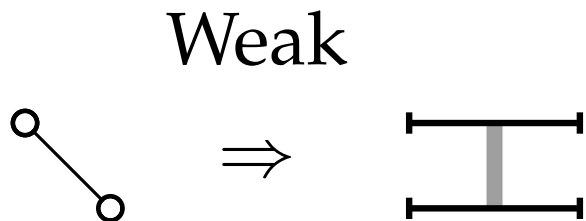

Unit Bar-Visibility

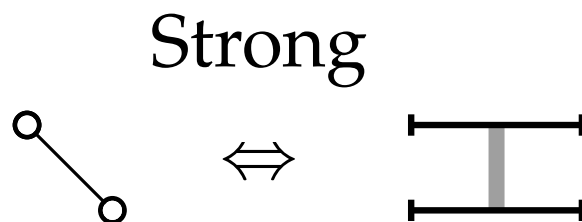
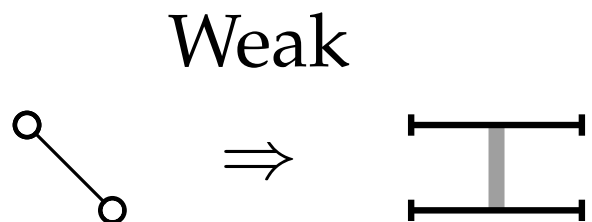
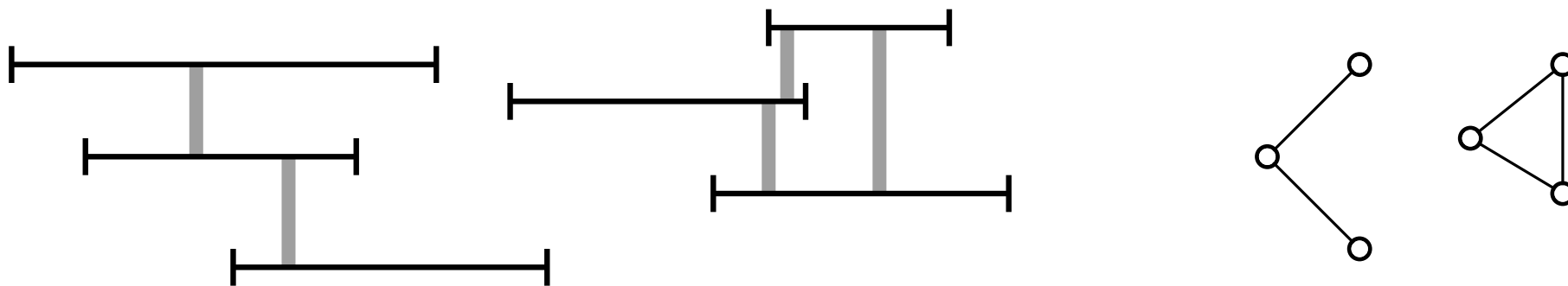

Unit Bar-Visibility

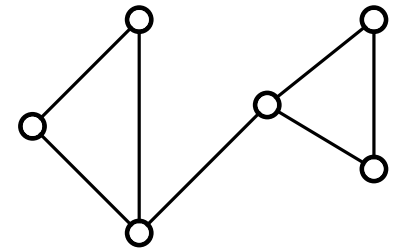
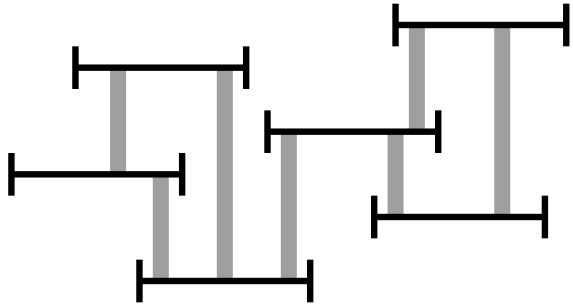

Weak

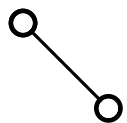

\Rightarrow

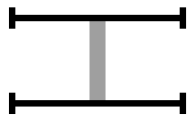

Strong

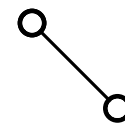

\Leftrightarrow



Unit Bar-Visibility

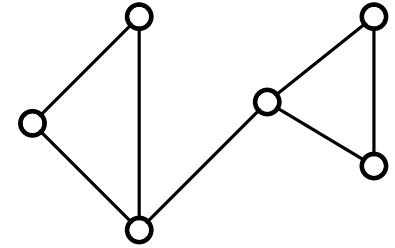
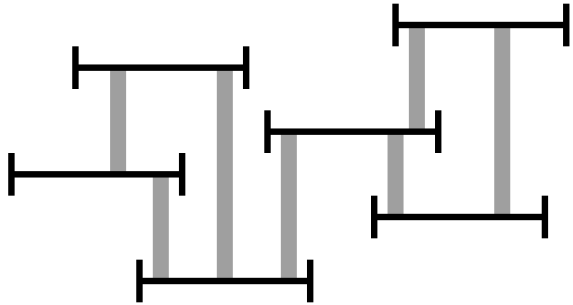

Characterizations for...

Weak

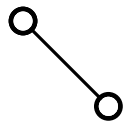

\Rightarrow



Strong

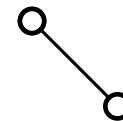

\Leftrightarrow



Unit Bar-Visibility

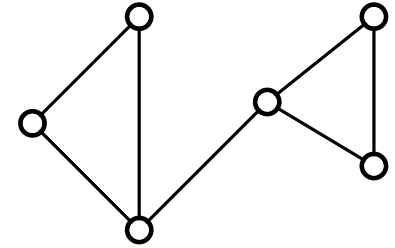
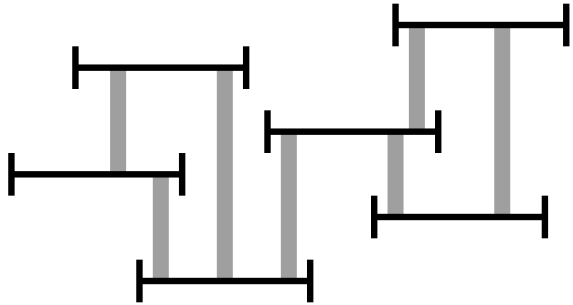

Characterizations for...

- trees

Weak

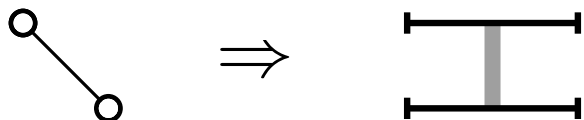

Strong

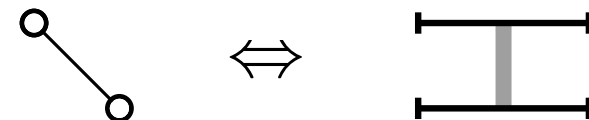

Unit Bar-Visibility

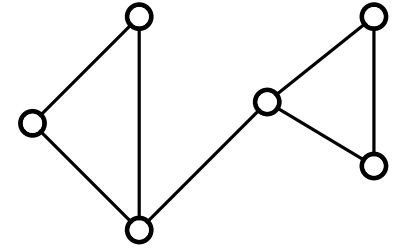
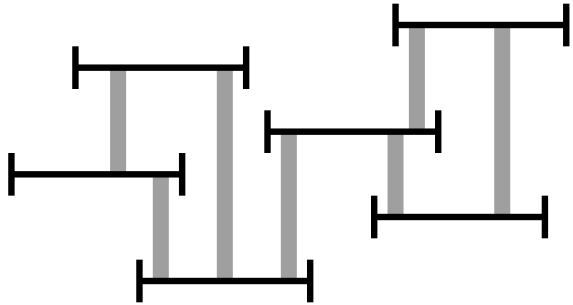

Characterizations for...

- trees
- complete bipartite

Weak

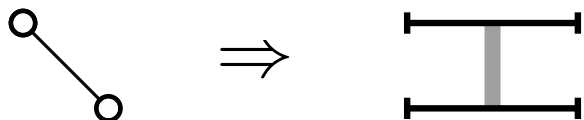

Strong

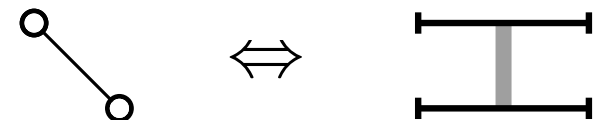

Unit Bar-Visibility

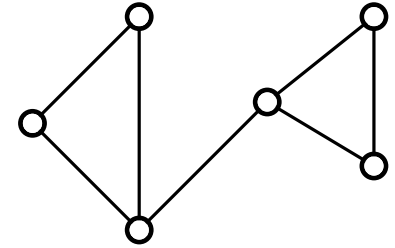
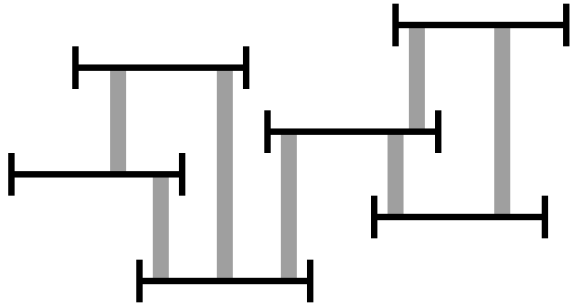

Characterizations for...

- trees
- complete bipartite
- outerplanar

Weak

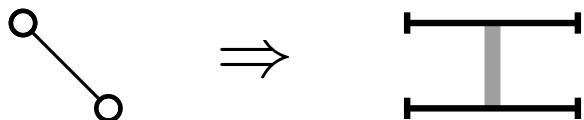

Strong

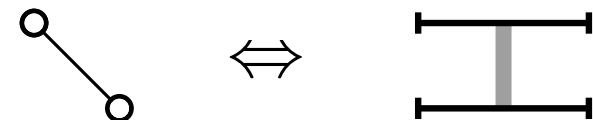

Unit Bar-Visibility

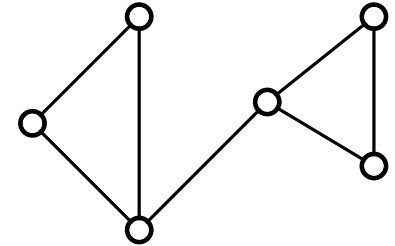
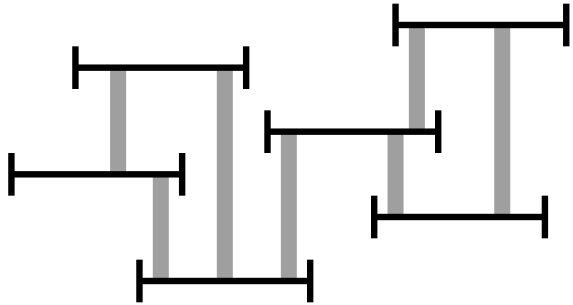

Characterizations for...

- trees
- complete bipartite
- outerplanar
- triangulations

Weak

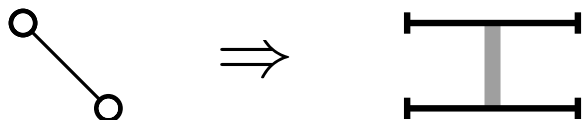

Strong

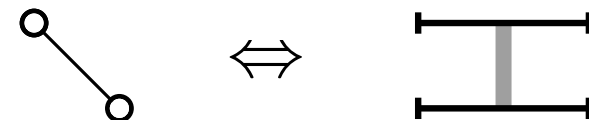

Integral Unit Bar-Visibility

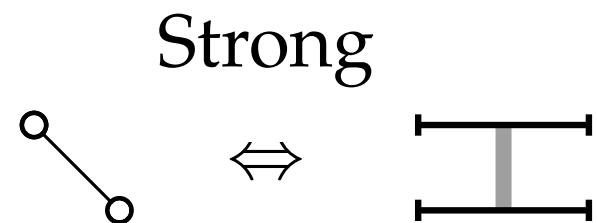
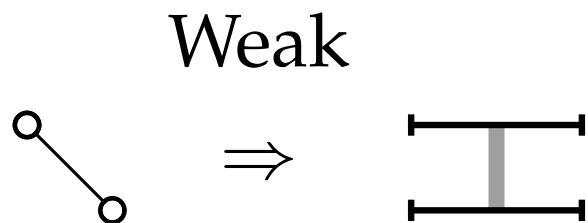
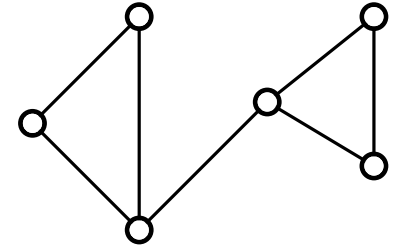
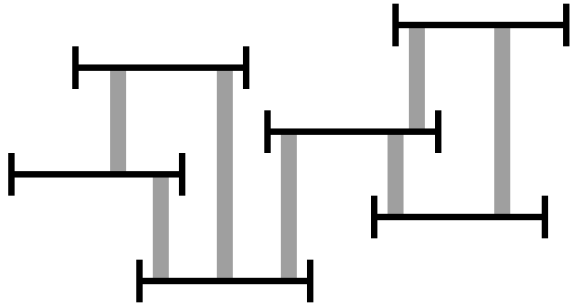

Integral Unit Bar-Visibility

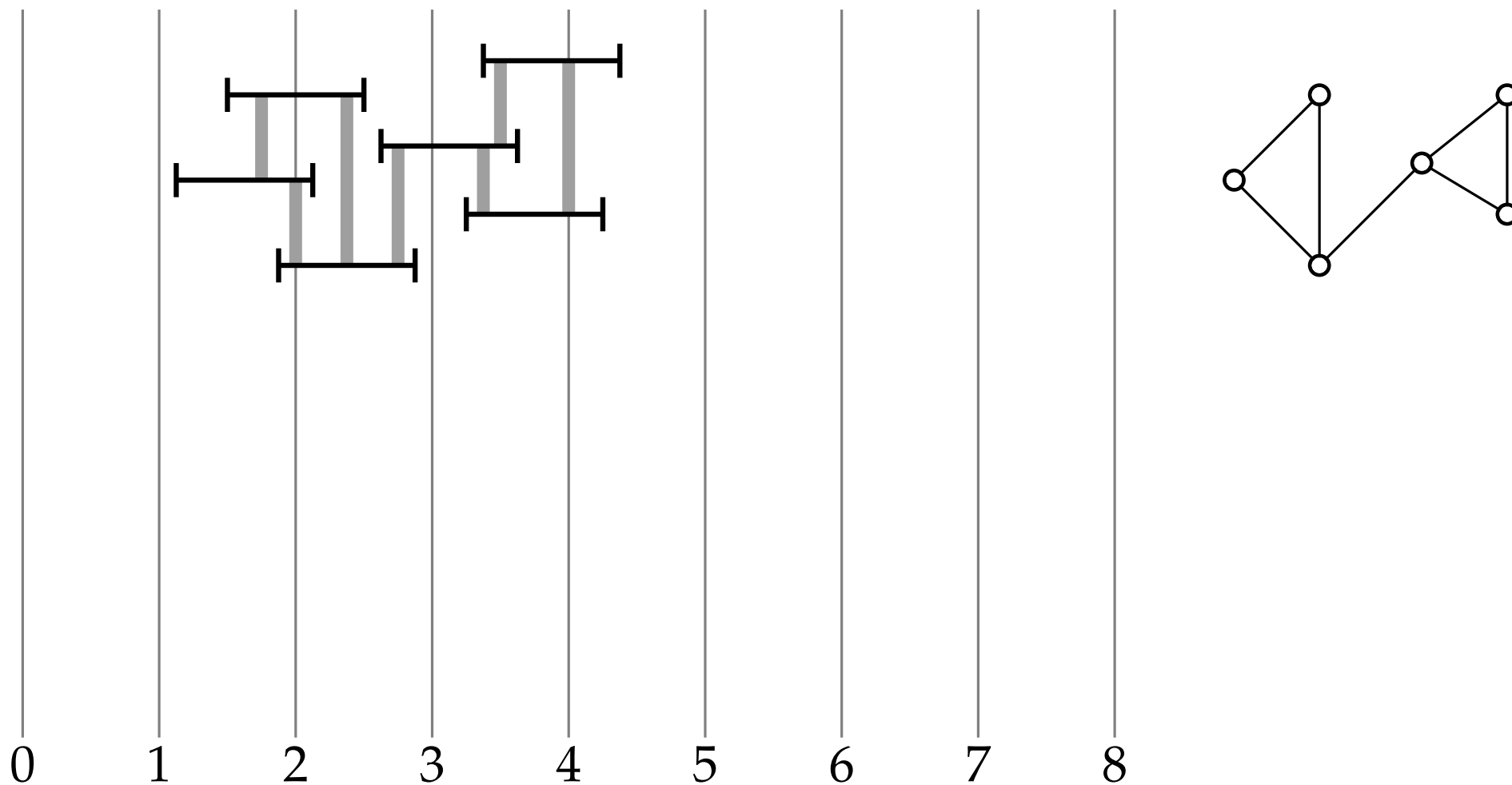

Weak

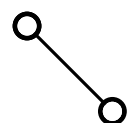

\Rightarrow

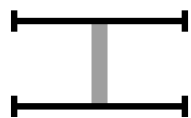

Strong

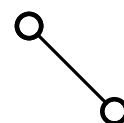

\Leftrightarrow



Integral Unit Bar-Visibility

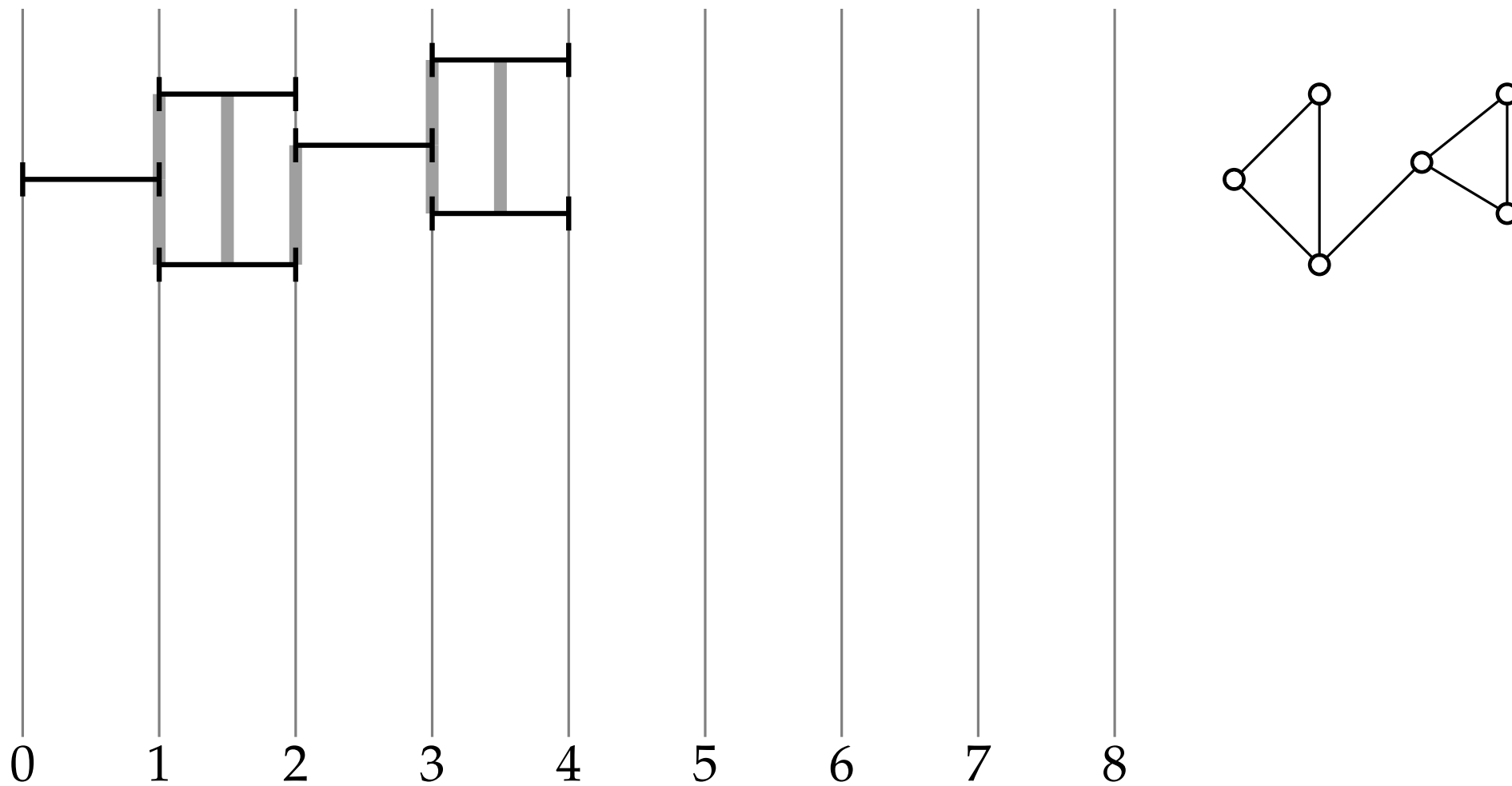

Weak

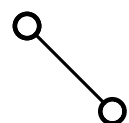

\Rightarrow

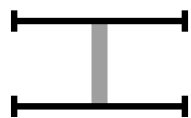

Strong

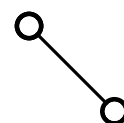

\Leftrightarrow



Integral Unit Bar-Visibility

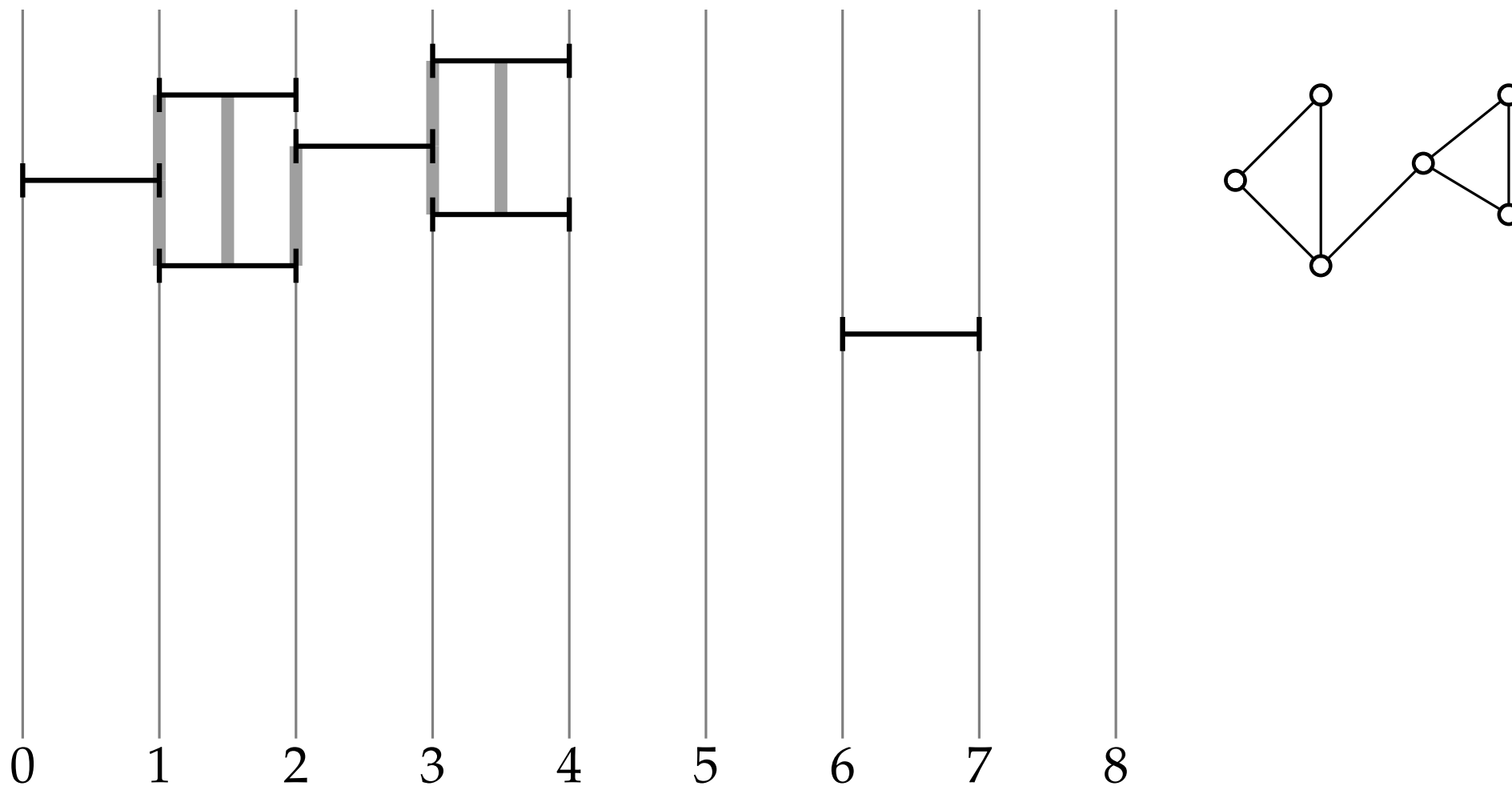

Weak

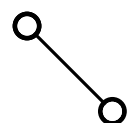

\Rightarrow

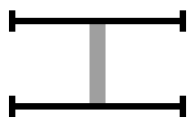

Strong

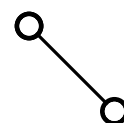

\Leftrightarrow



Integral Unit Bar-Visibility

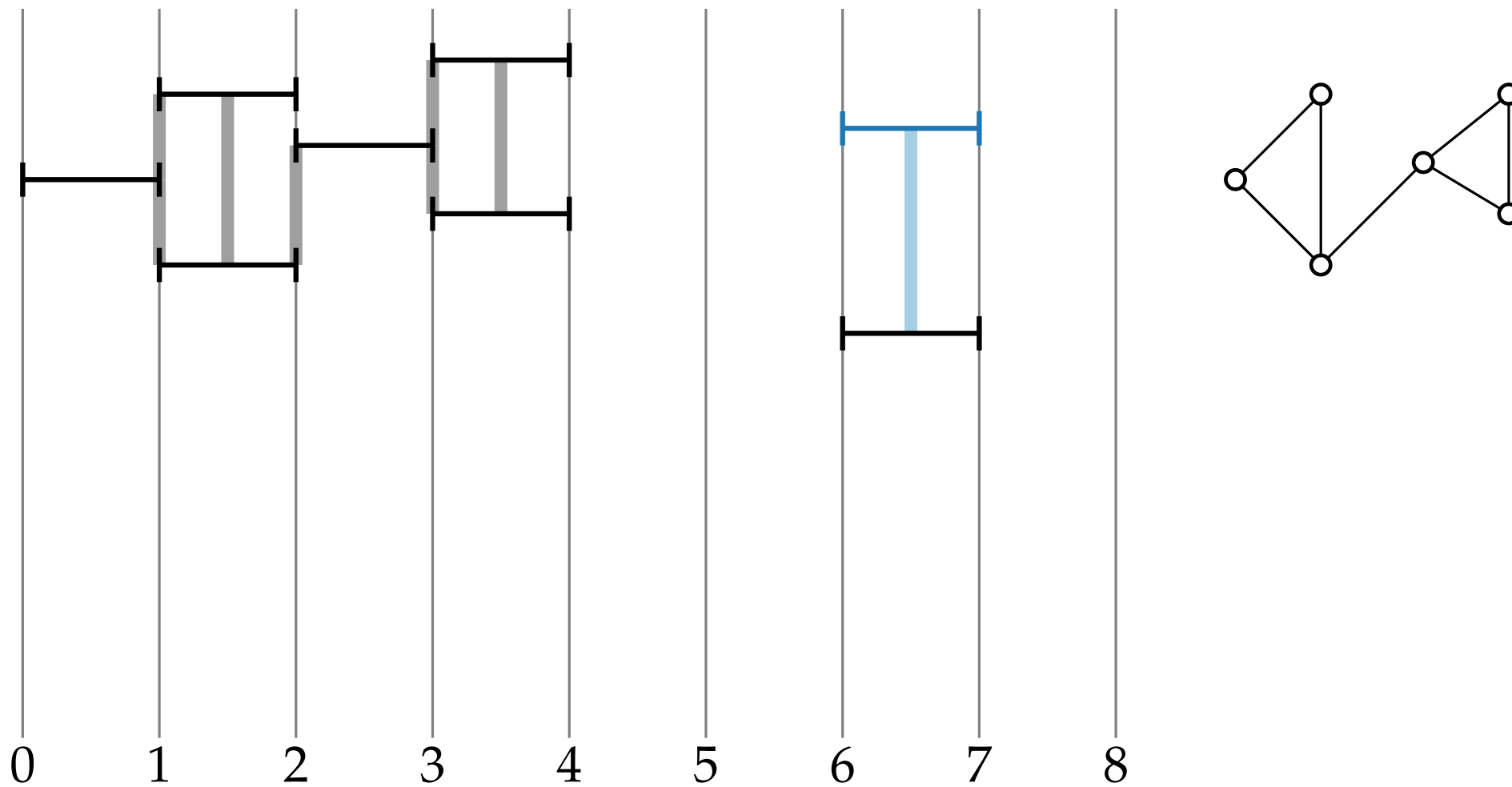

Weak

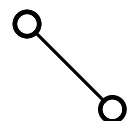

\Rightarrow

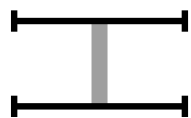

Strong

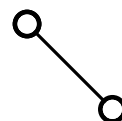

\Leftrightarrow



Integral Unit Bar-Visibility

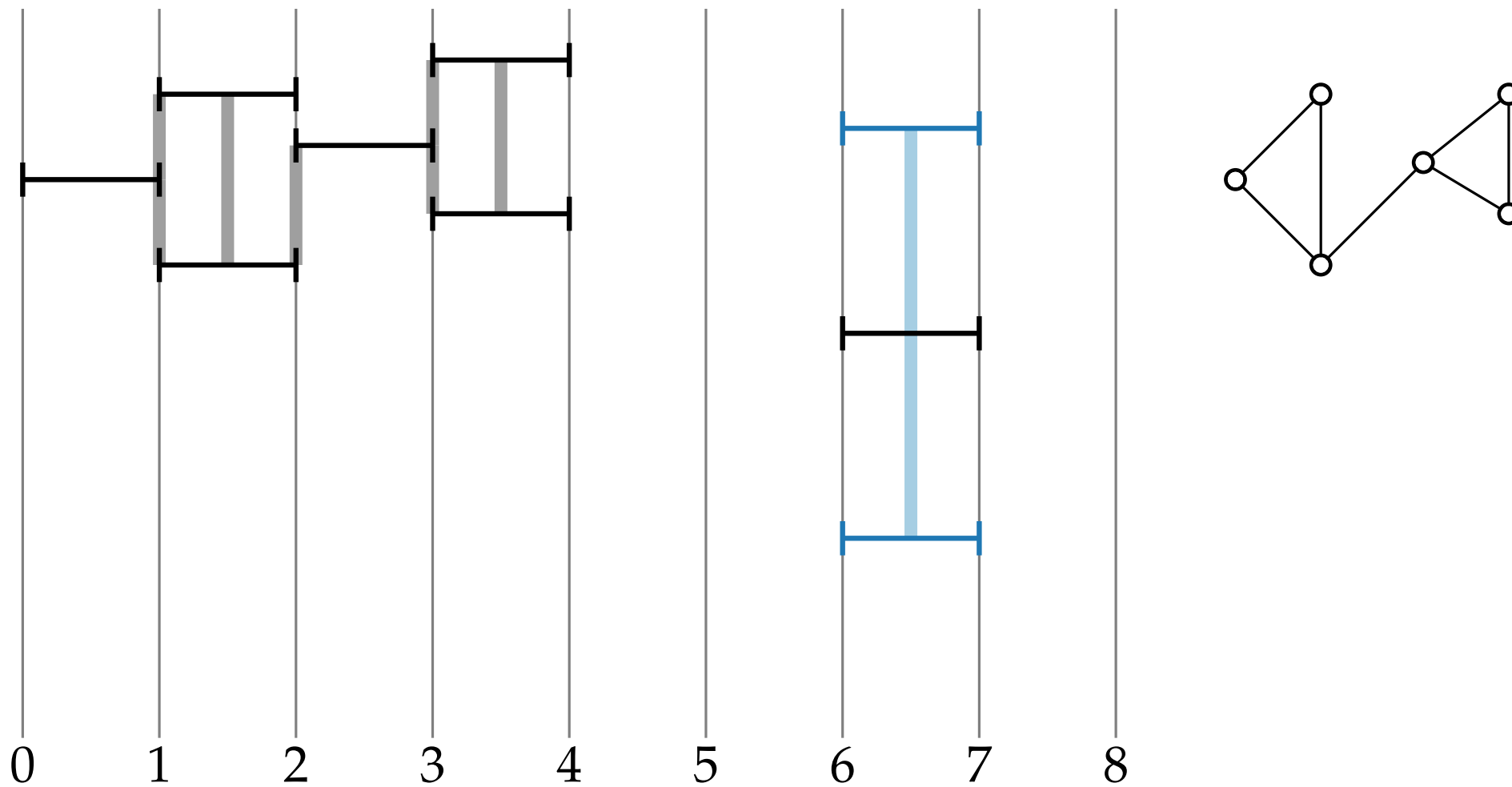

Weak

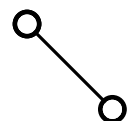

\Rightarrow

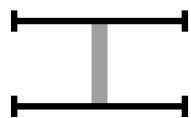

Strong

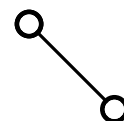

\Leftrightarrow



Integral Unit Bar-Visibility

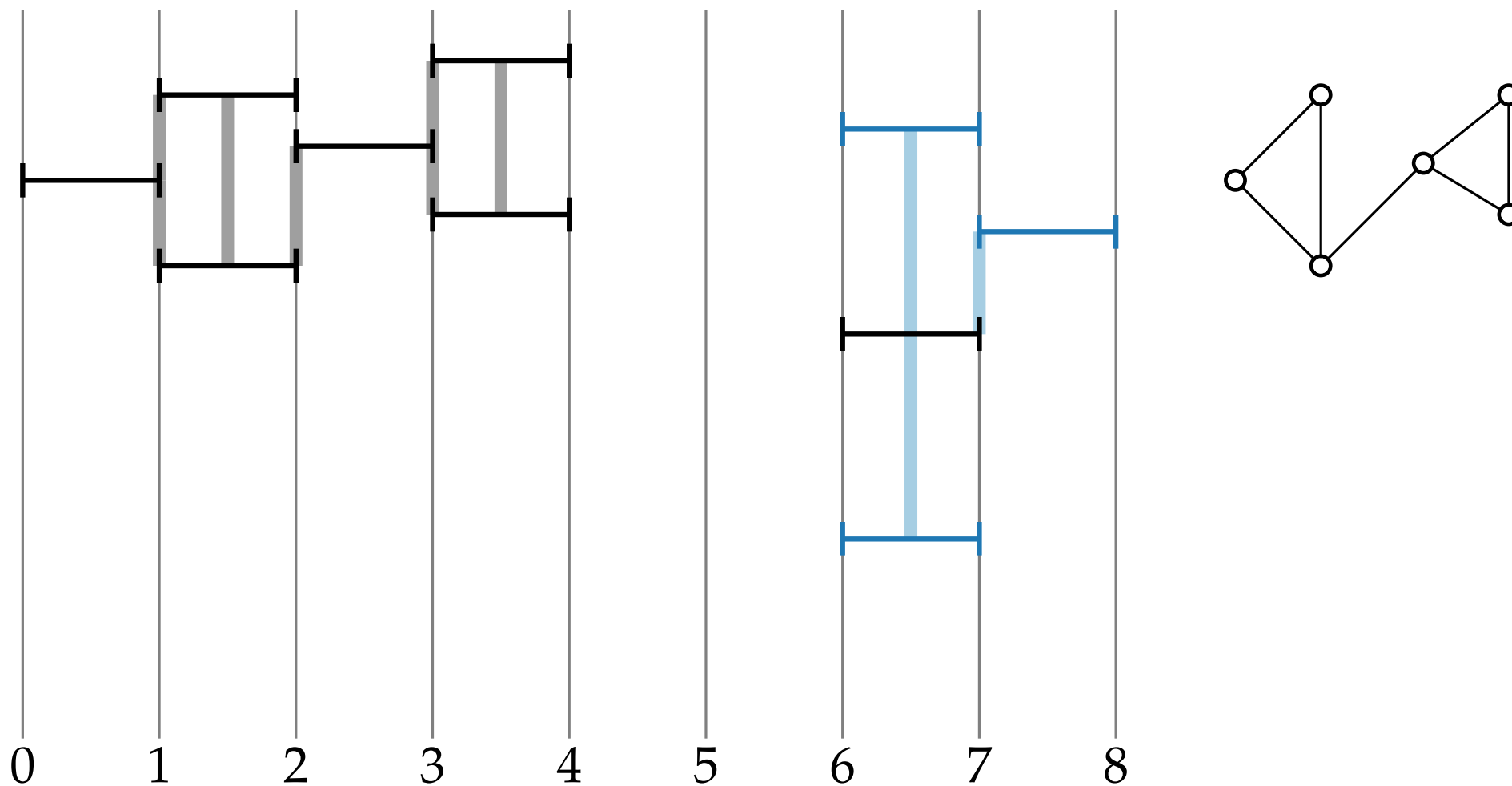

Weak

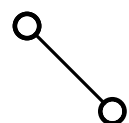

\Rightarrow

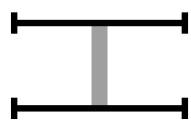

Strong

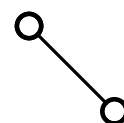

\Leftrightarrow



Integral Unit Bar-Visibility

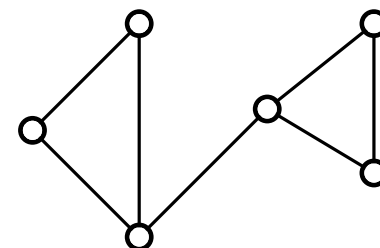
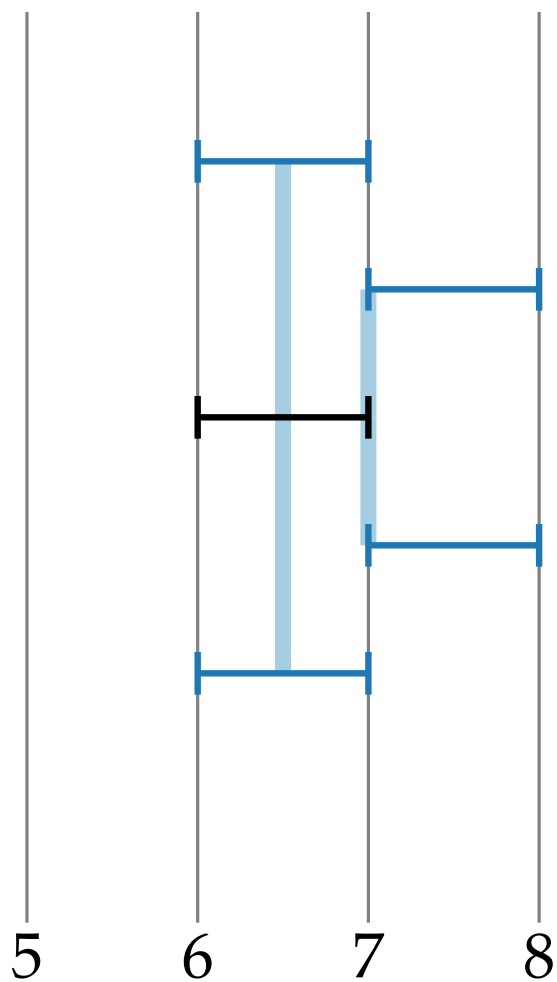
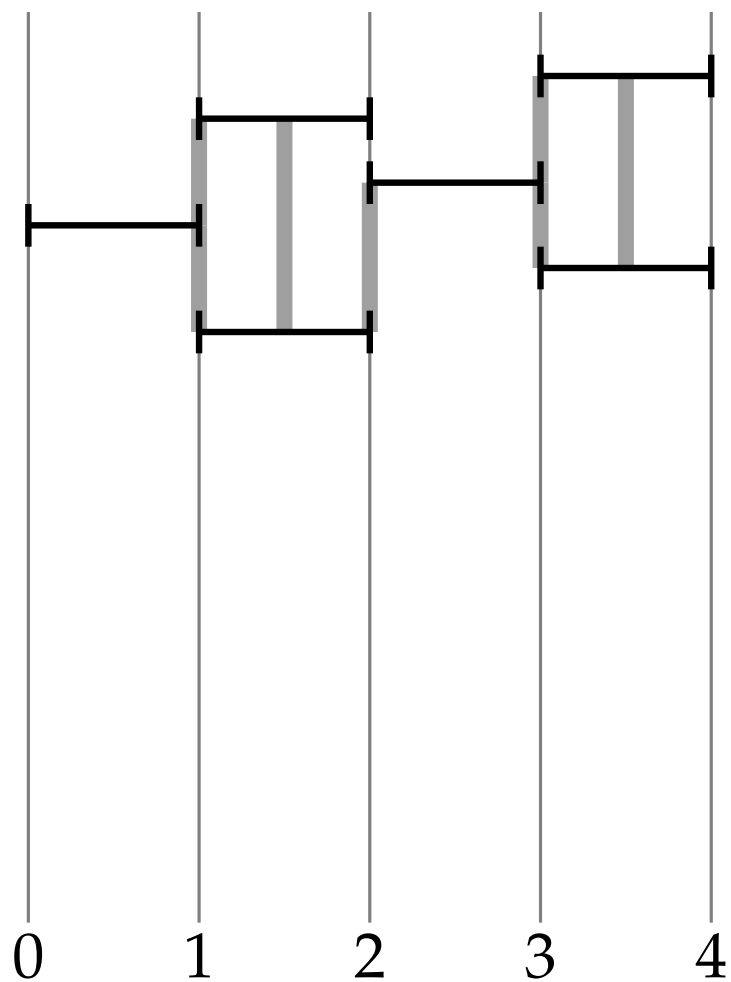

Weak

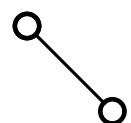

\Rightarrow

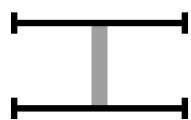

Strong

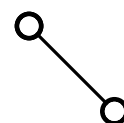

\Leftrightarrow

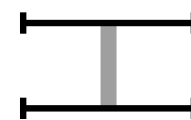

Integral Unit Bar-Visibility

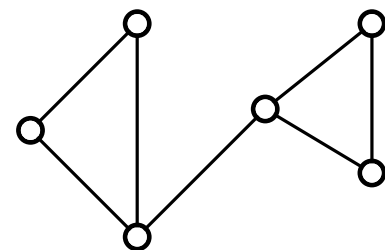
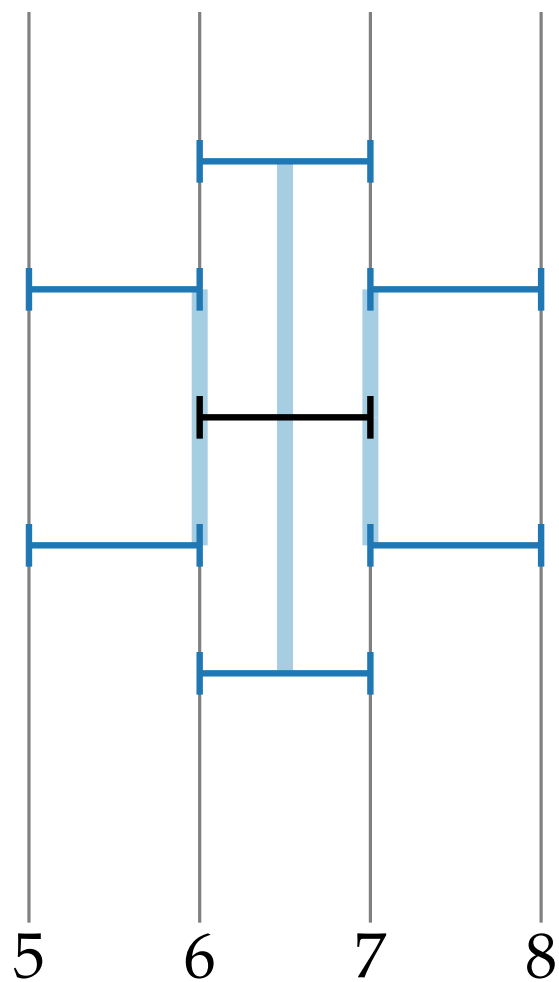
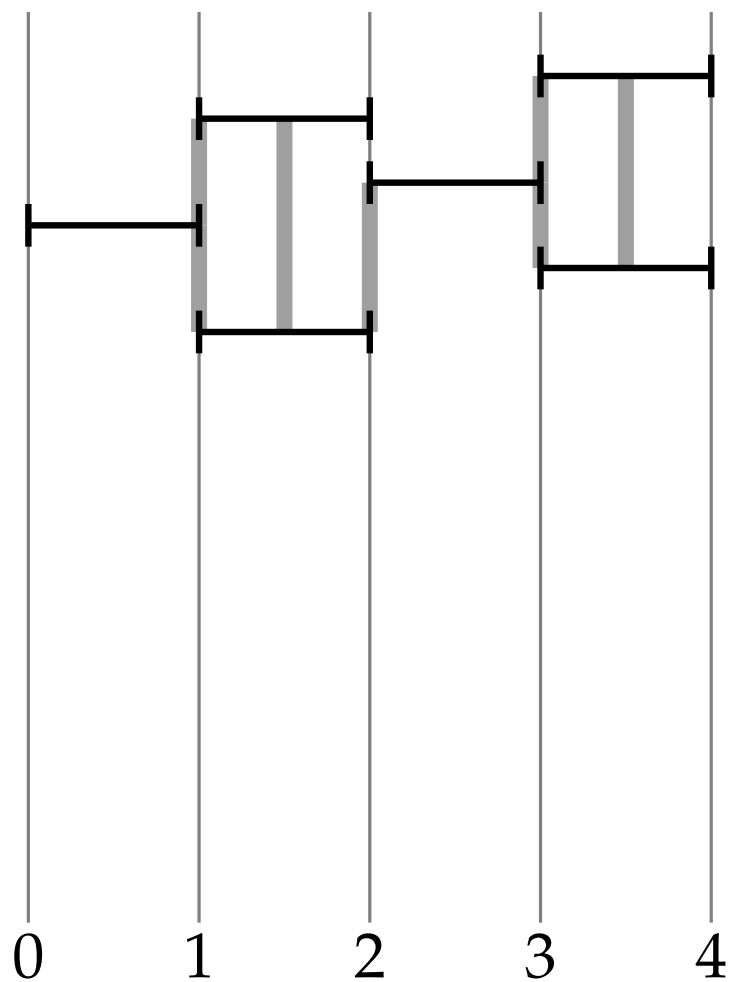

Weak

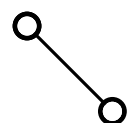

\Rightarrow

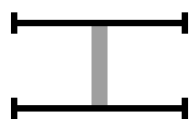

Strong

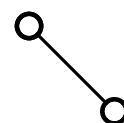

\Leftrightarrow



Integral Unit Bar-Visibility

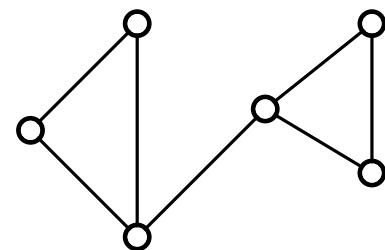
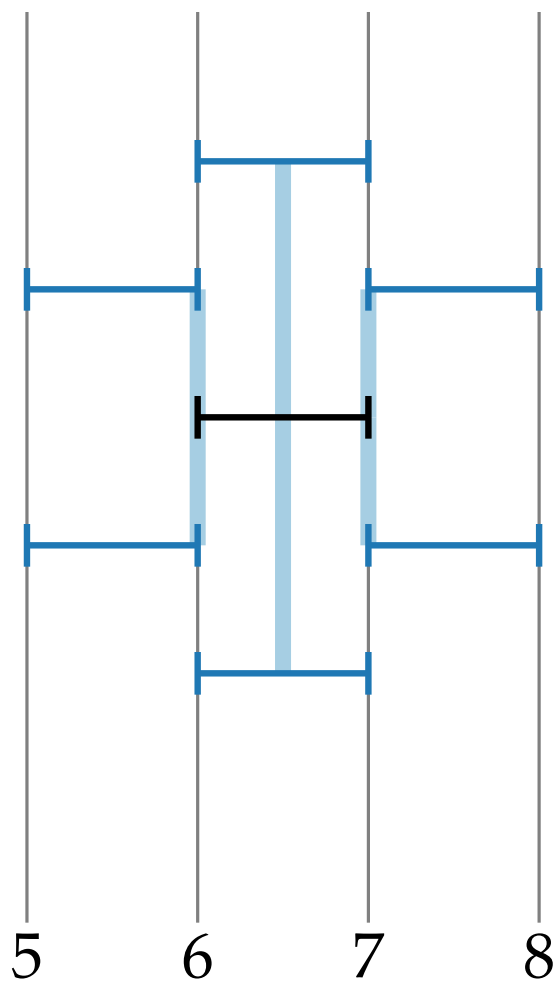
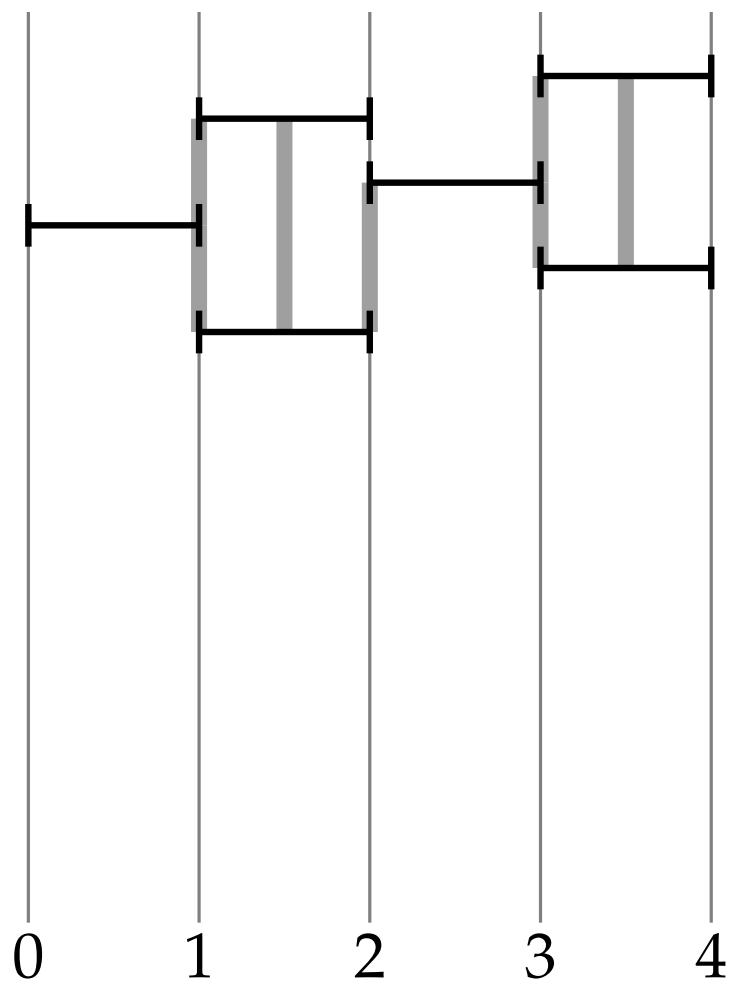

max-deg 6

Weak

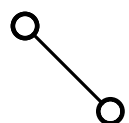

\Rightarrow

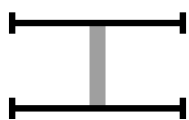

Strong

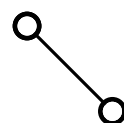

\Leftrightarrow



Weak Model

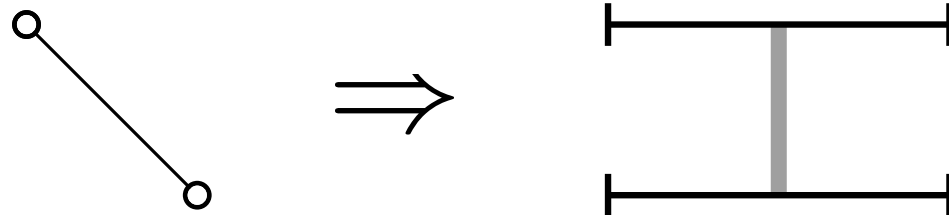

Weak: Trees, maxdeg 5

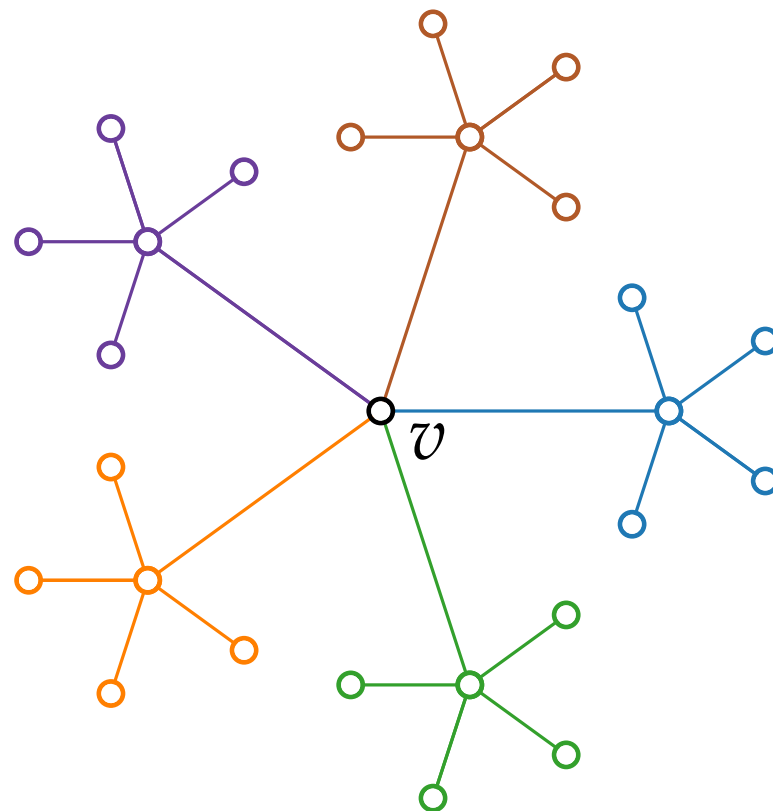
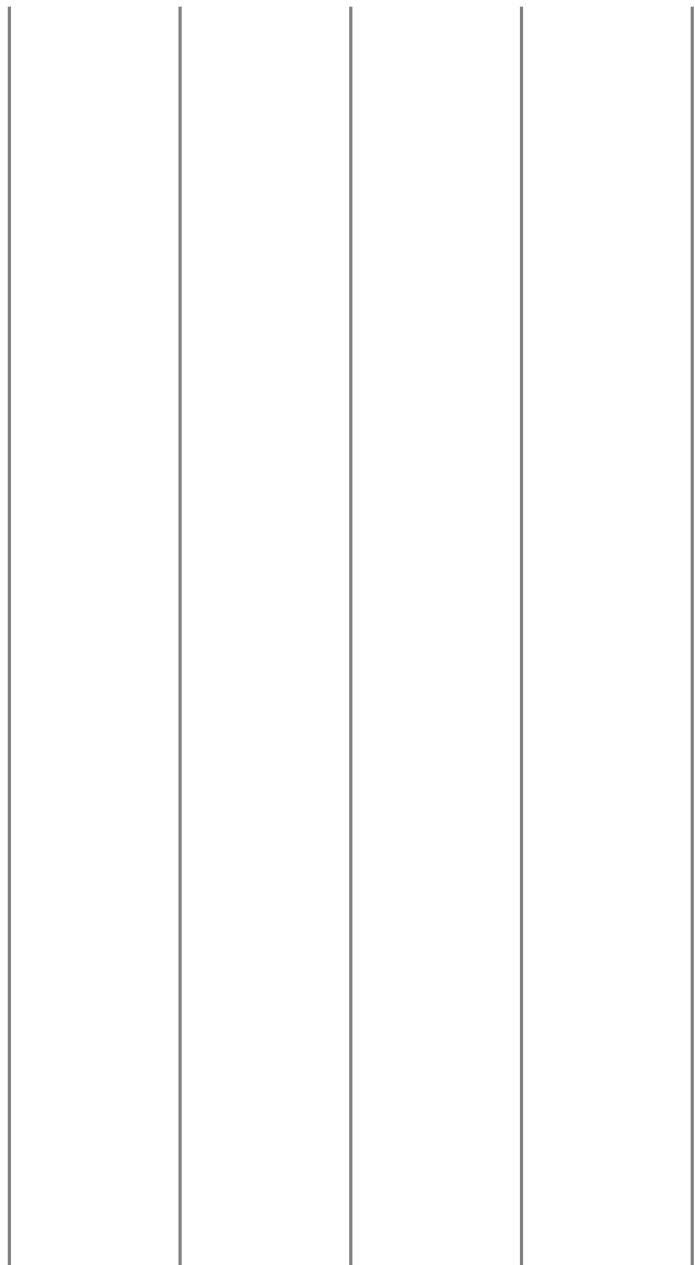

Weak: Trees, maxdeg 5

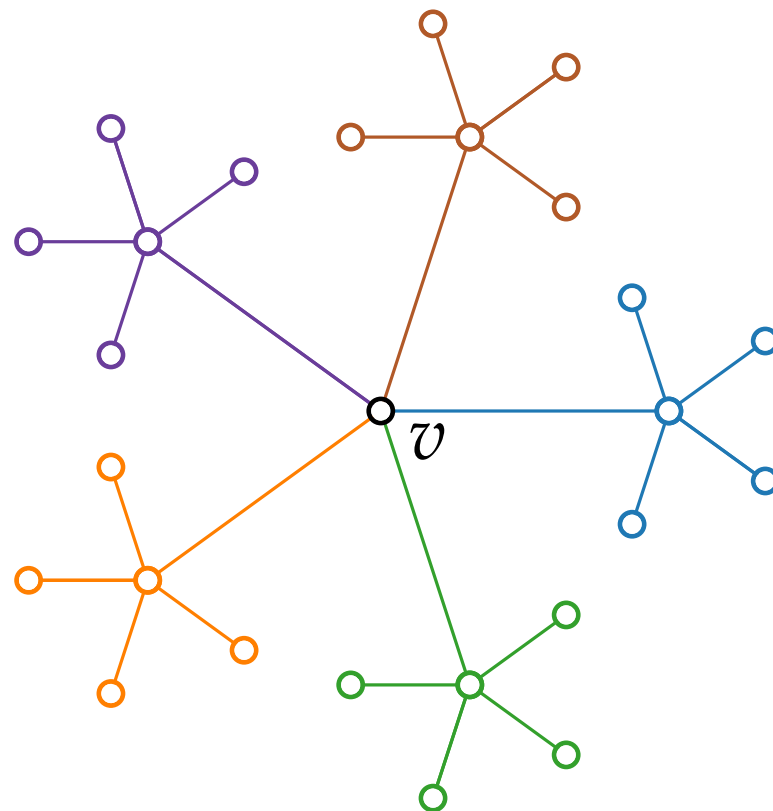
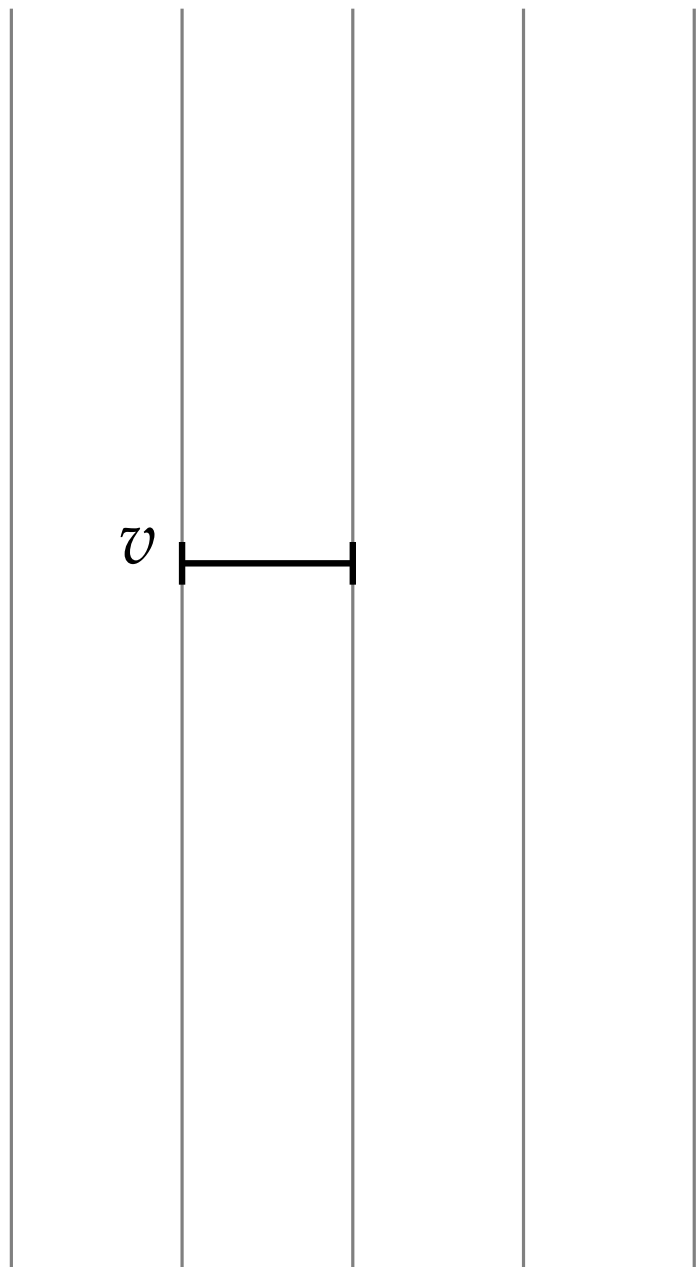

Weak: Trees, maxdeg 5

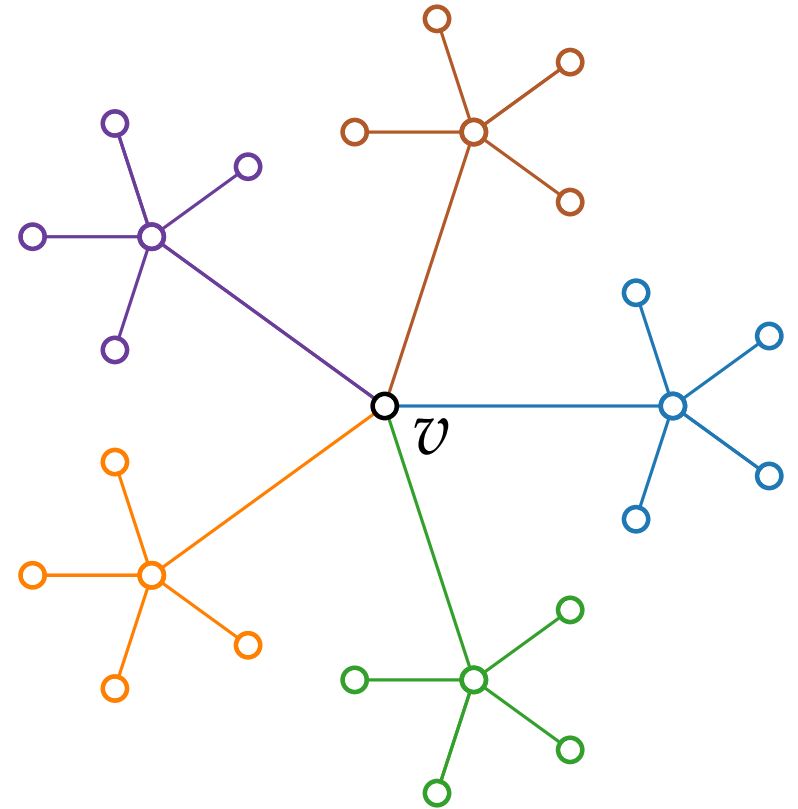
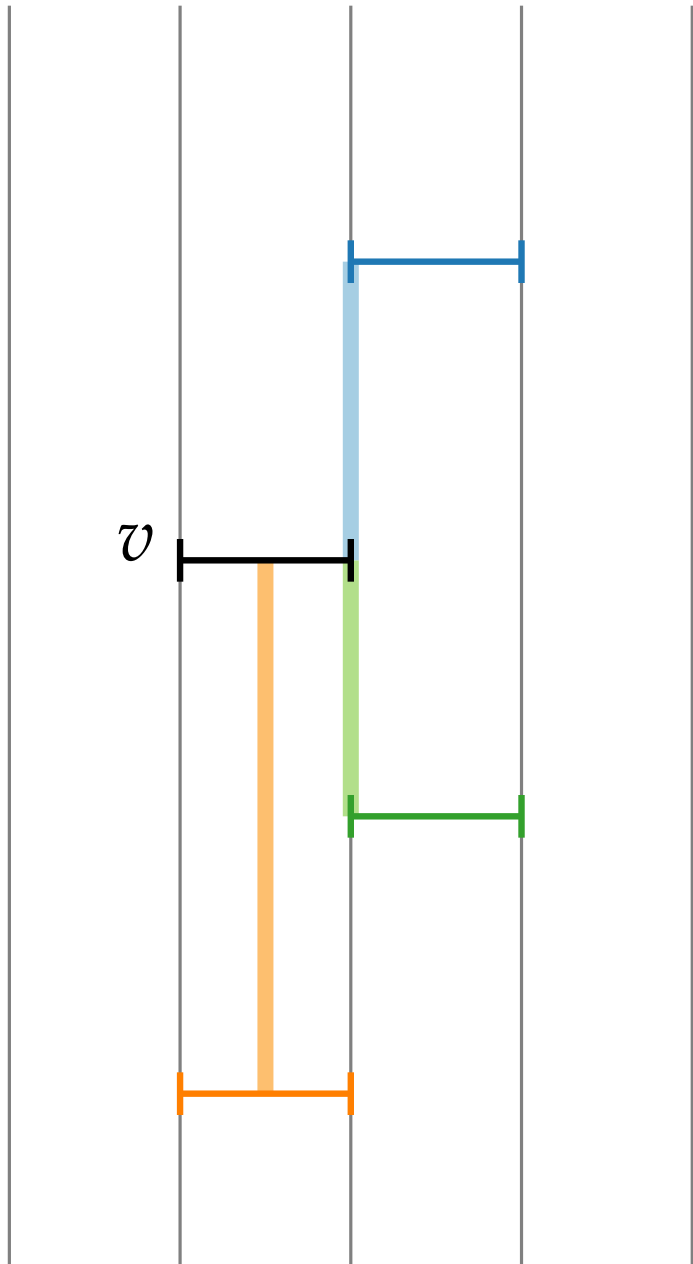

Weak: Trees, maxdeg 5

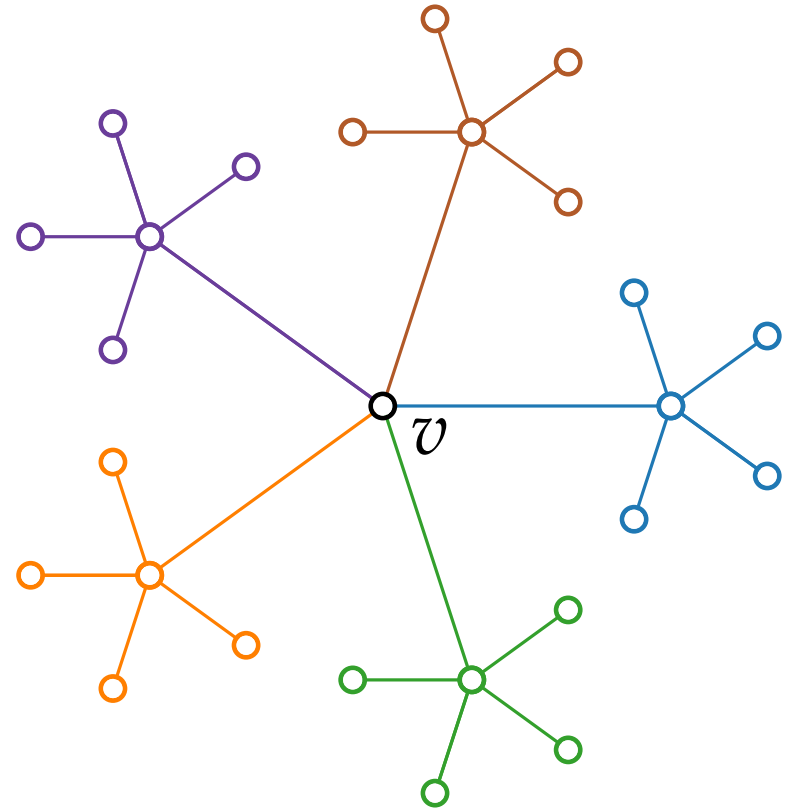
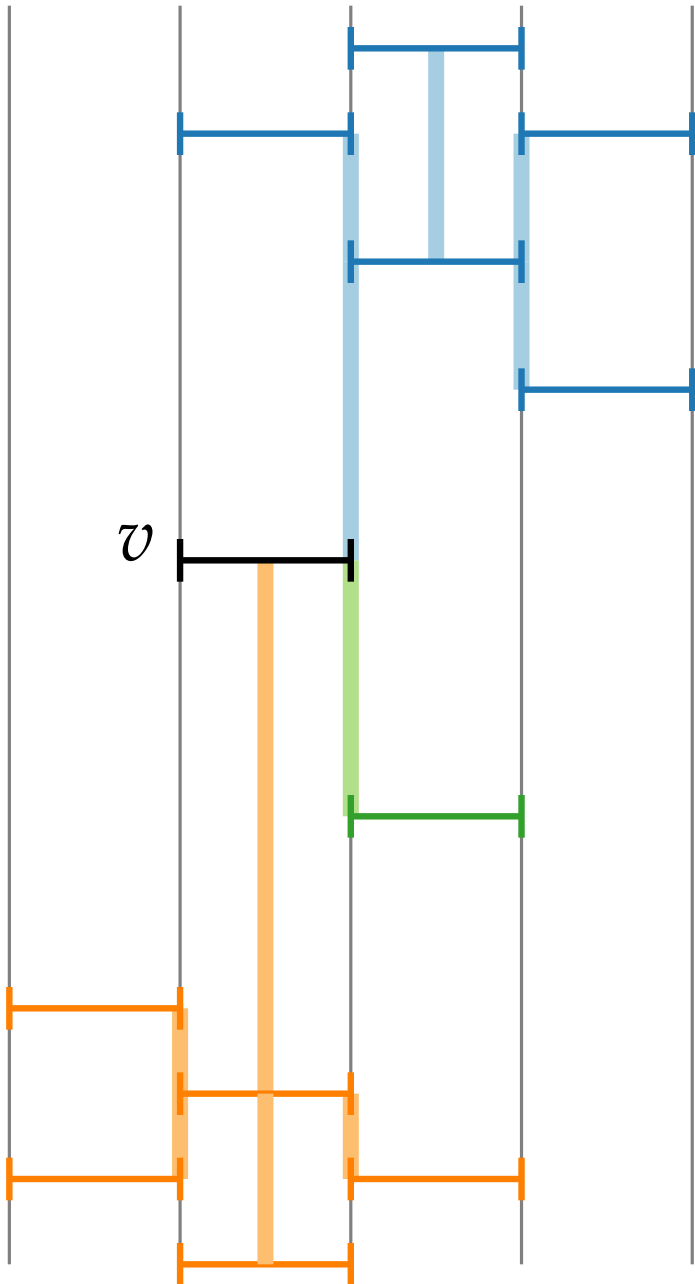

Weak: Trees, maxdeg 5

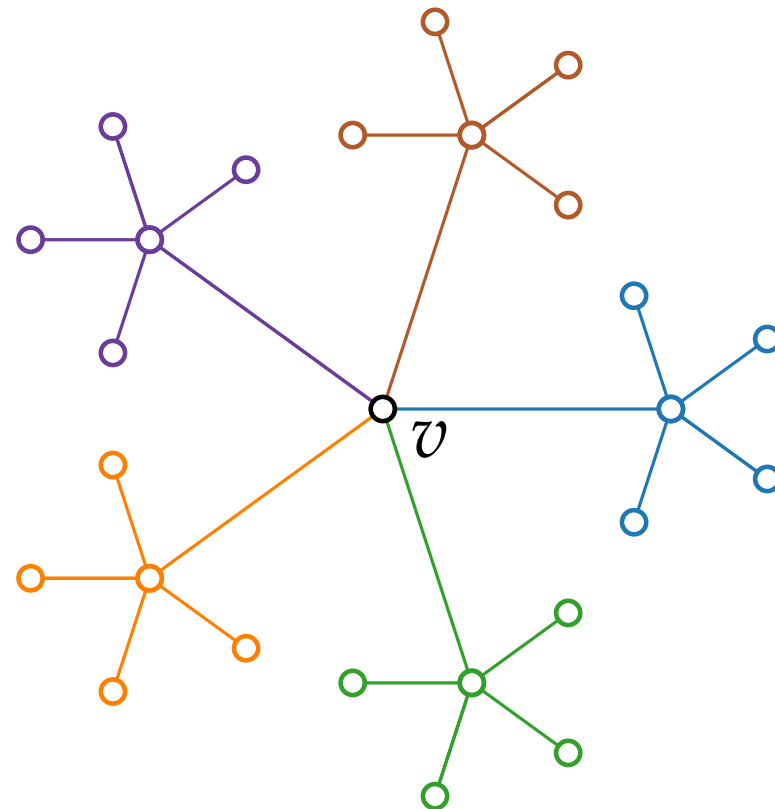
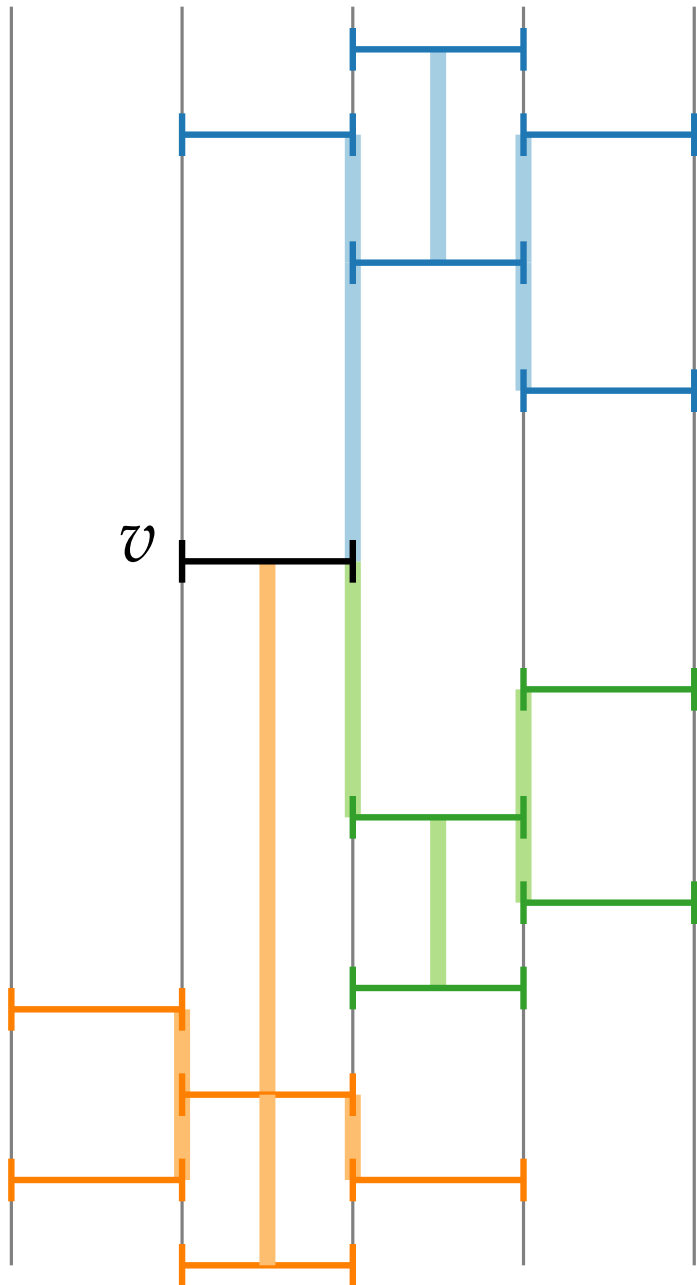

Weak: Trees, maxdeg 5

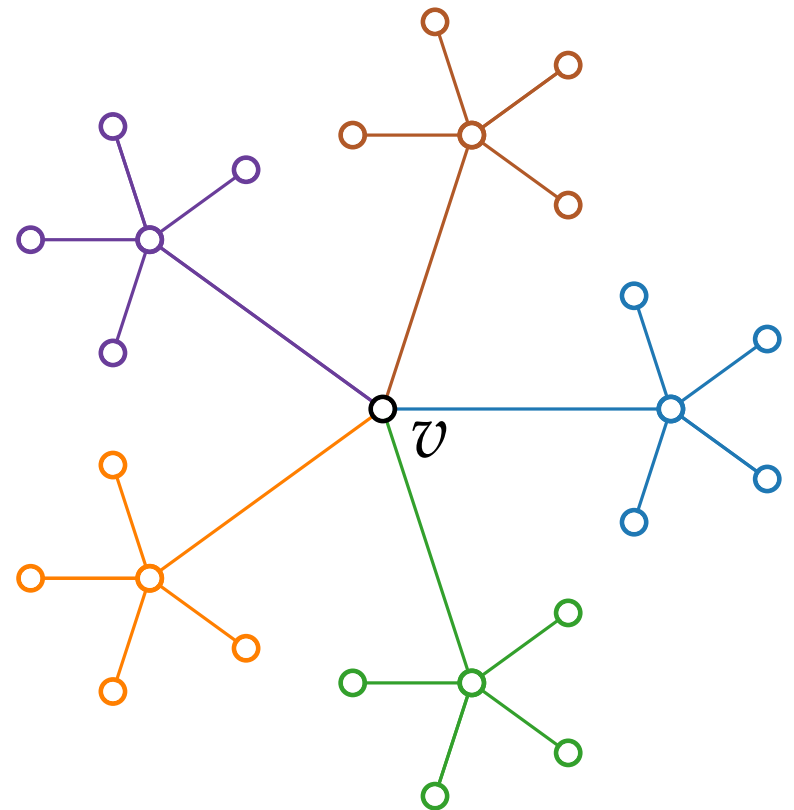
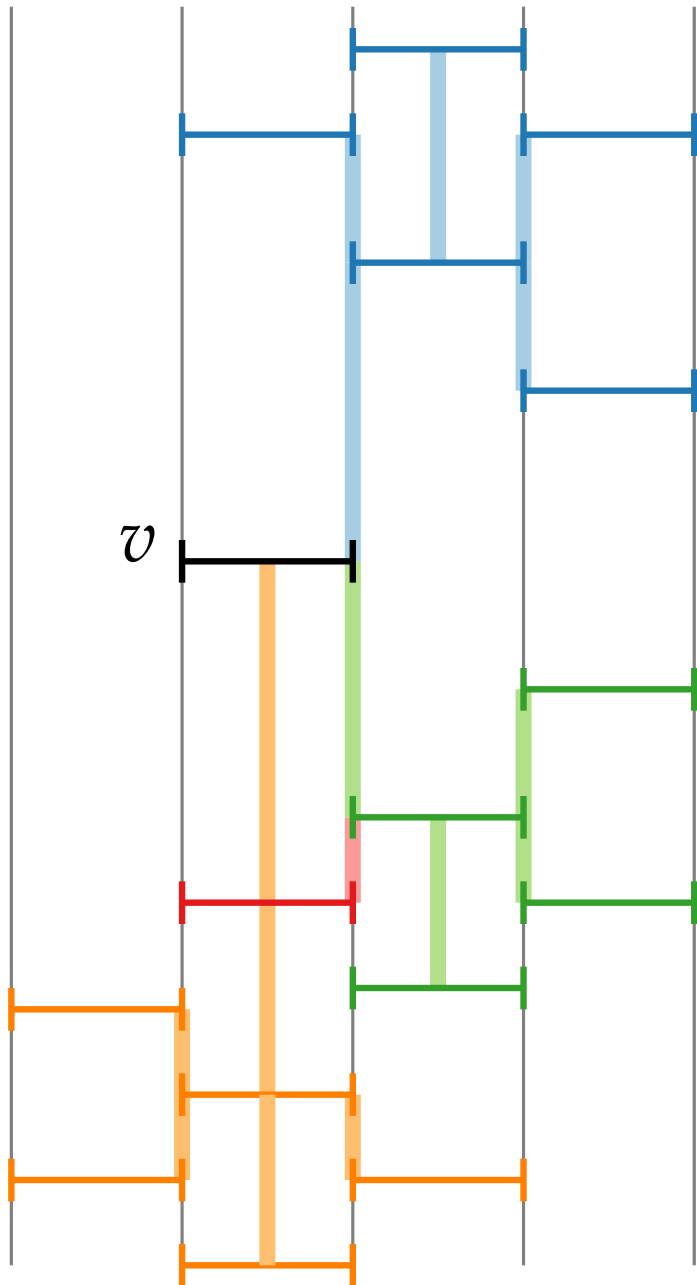

Weak: Trees, maxdeg 5

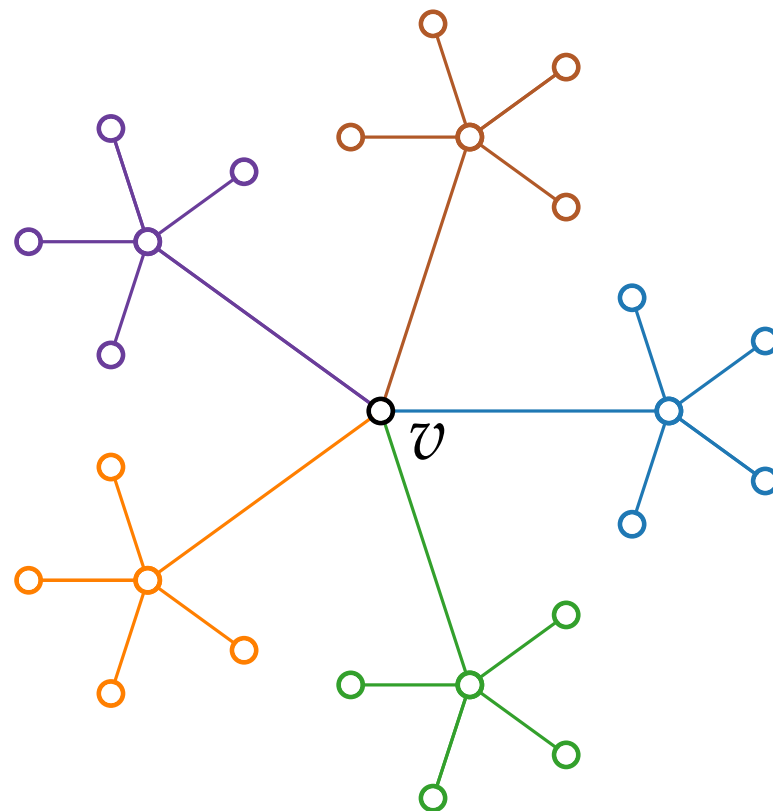
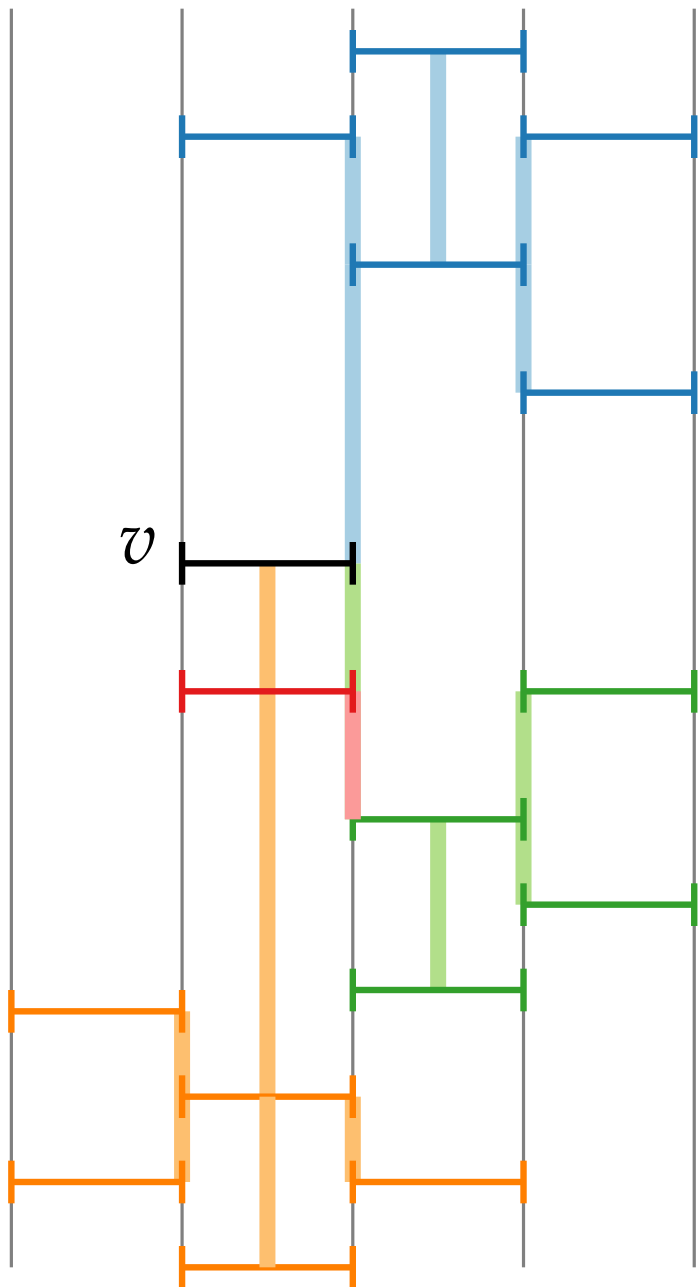

Weak: Trees, maxdeg 5

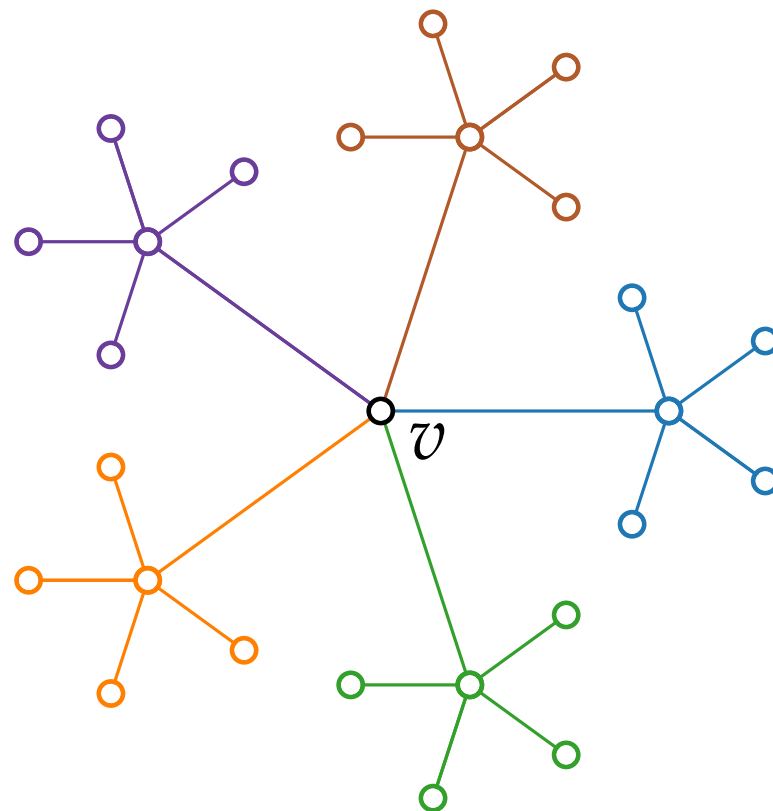
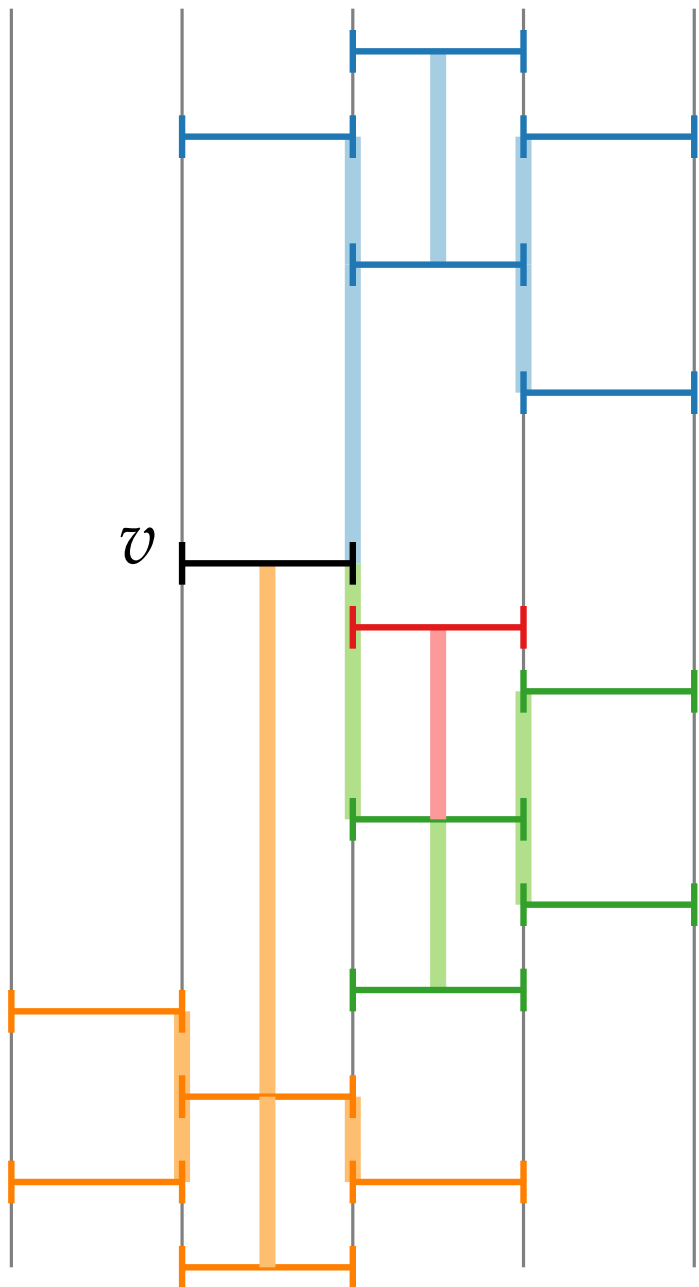

Weak: Trees, maxdeg 5

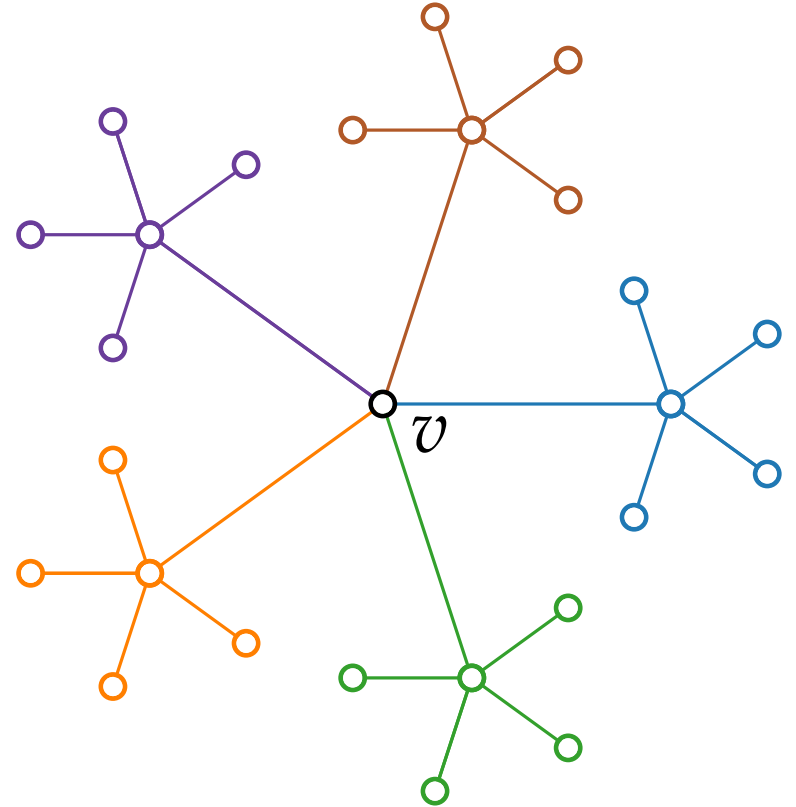
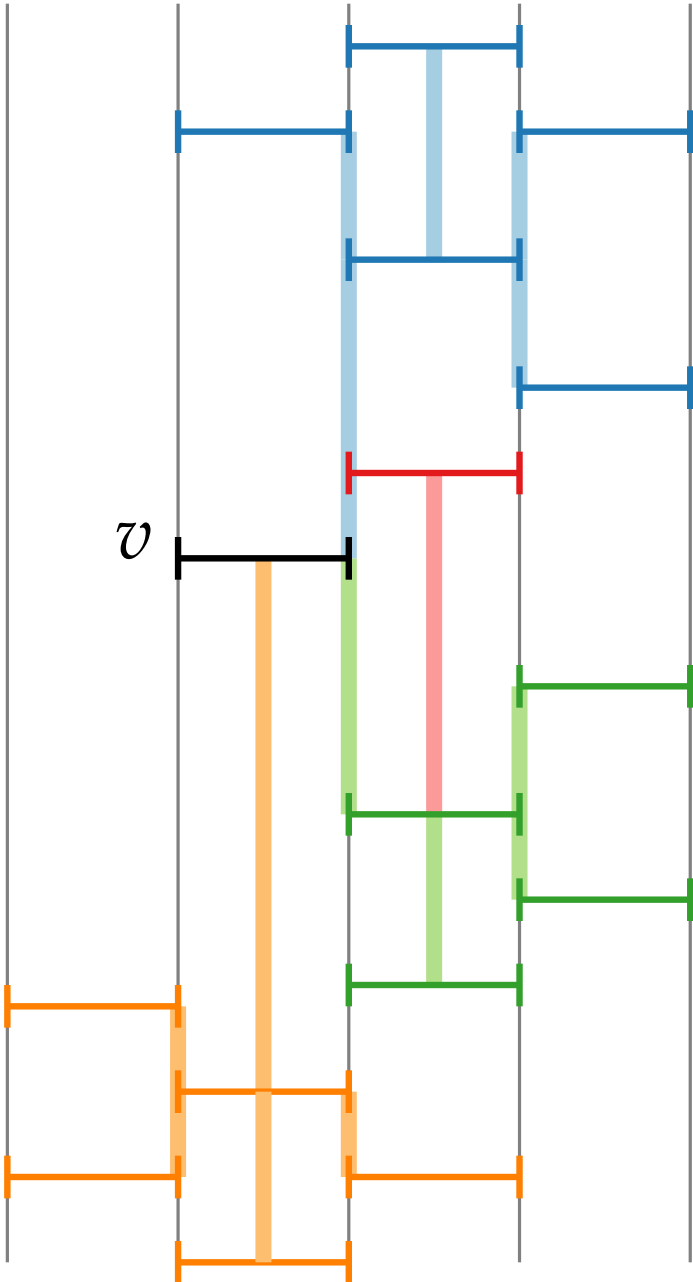

Weak: Trees, maxdeg 5

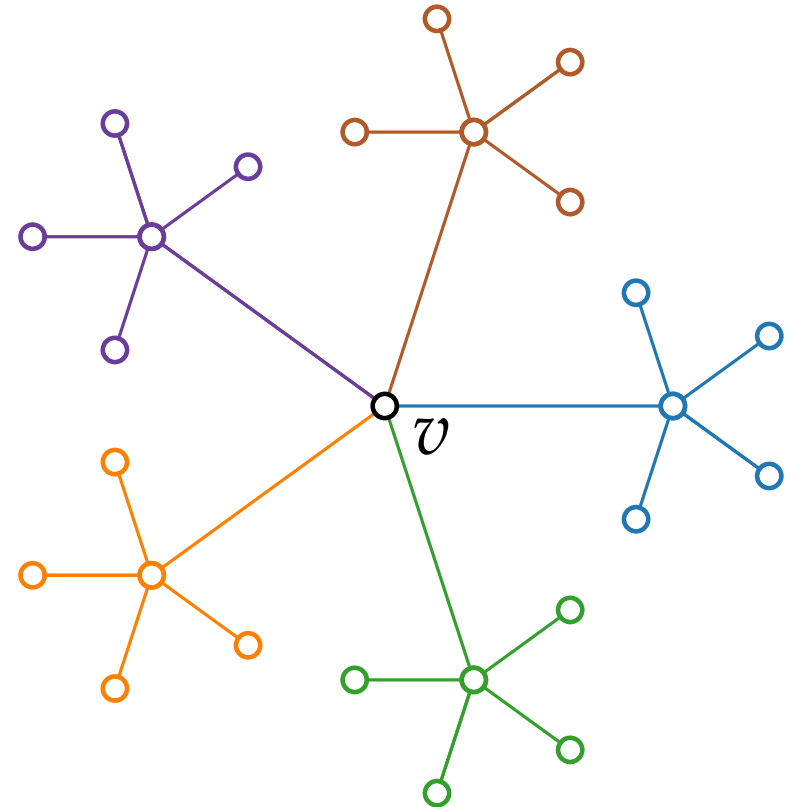
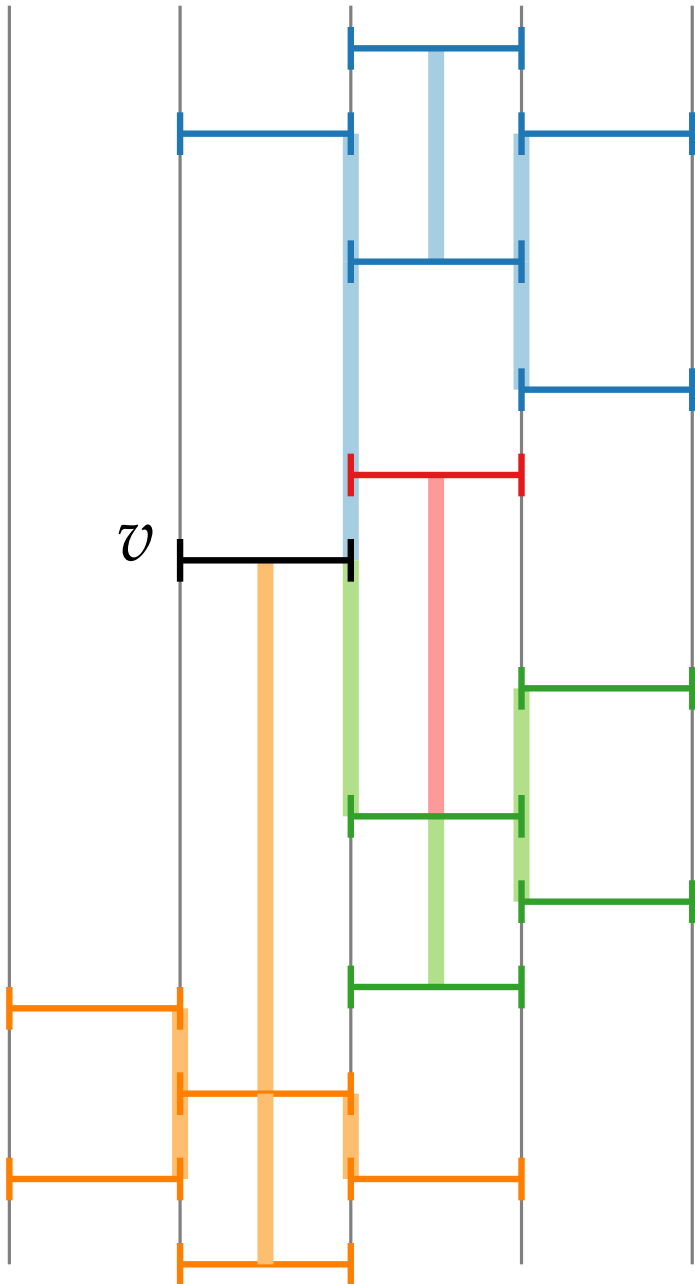

Tree with maxdeg 5 **X**

Weak: Trees, maxdeg 4

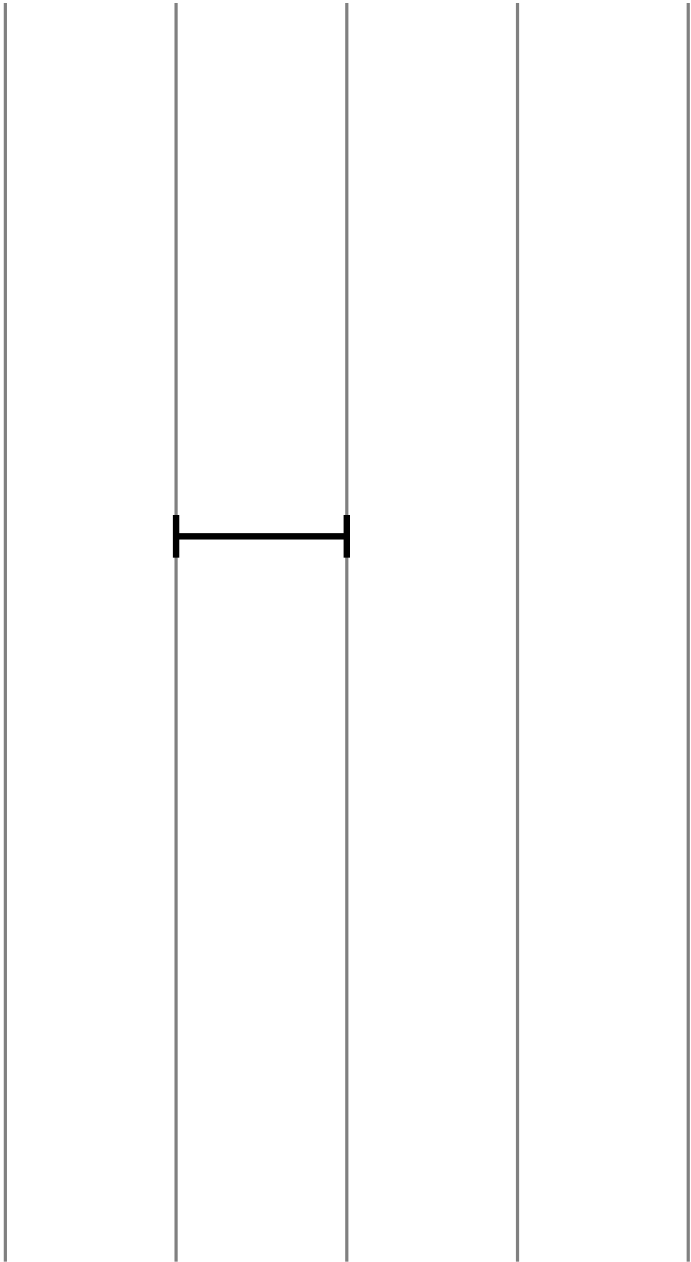

Weak: Trees, maxdeg 4

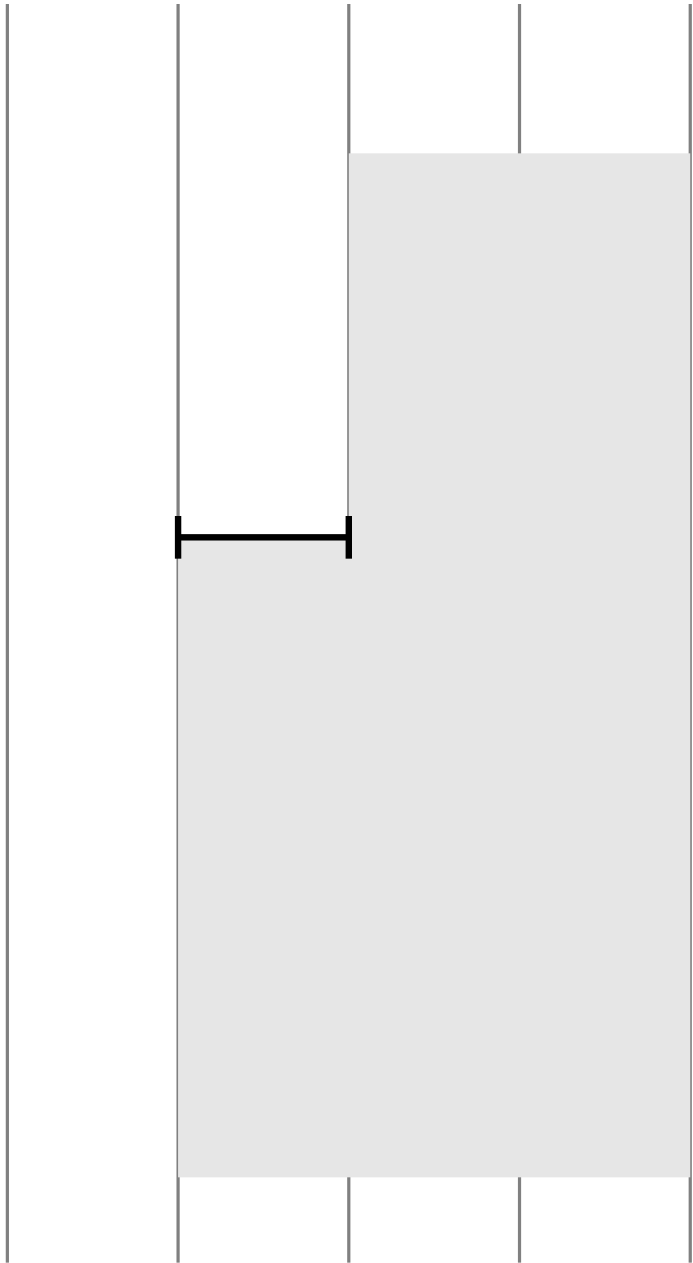

Weak: Trees, maxdeg 4

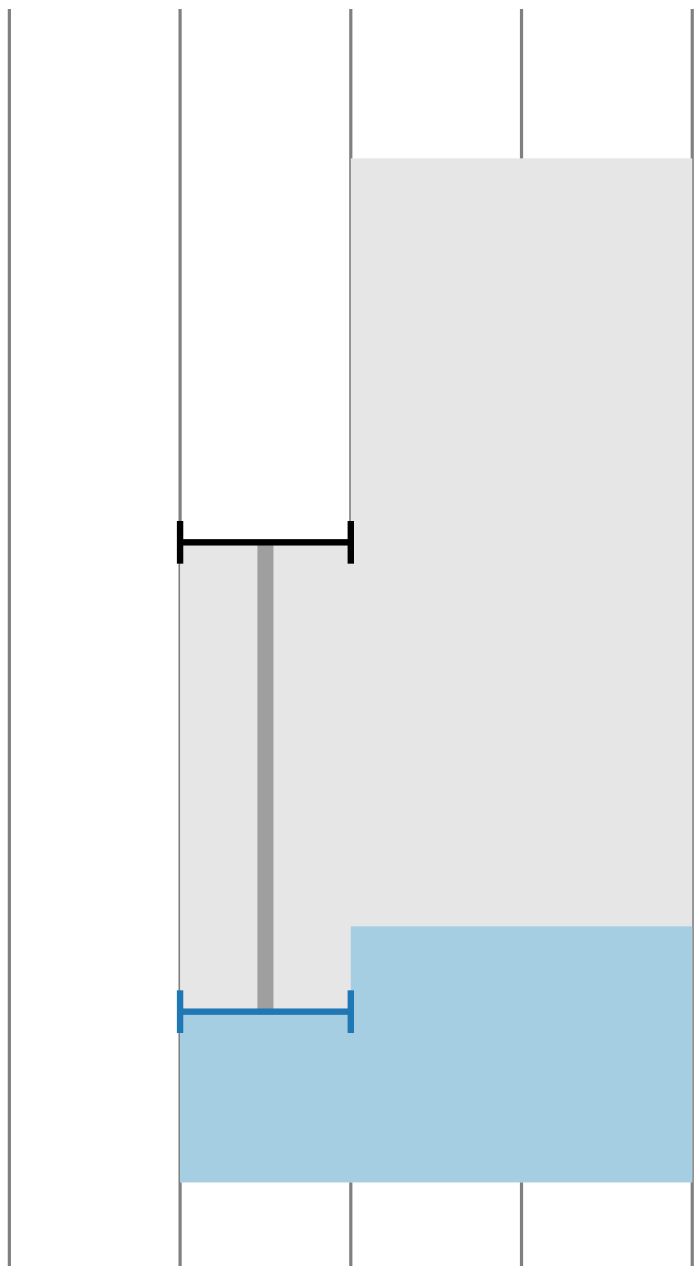

Weak: Trees, maxdeg 4

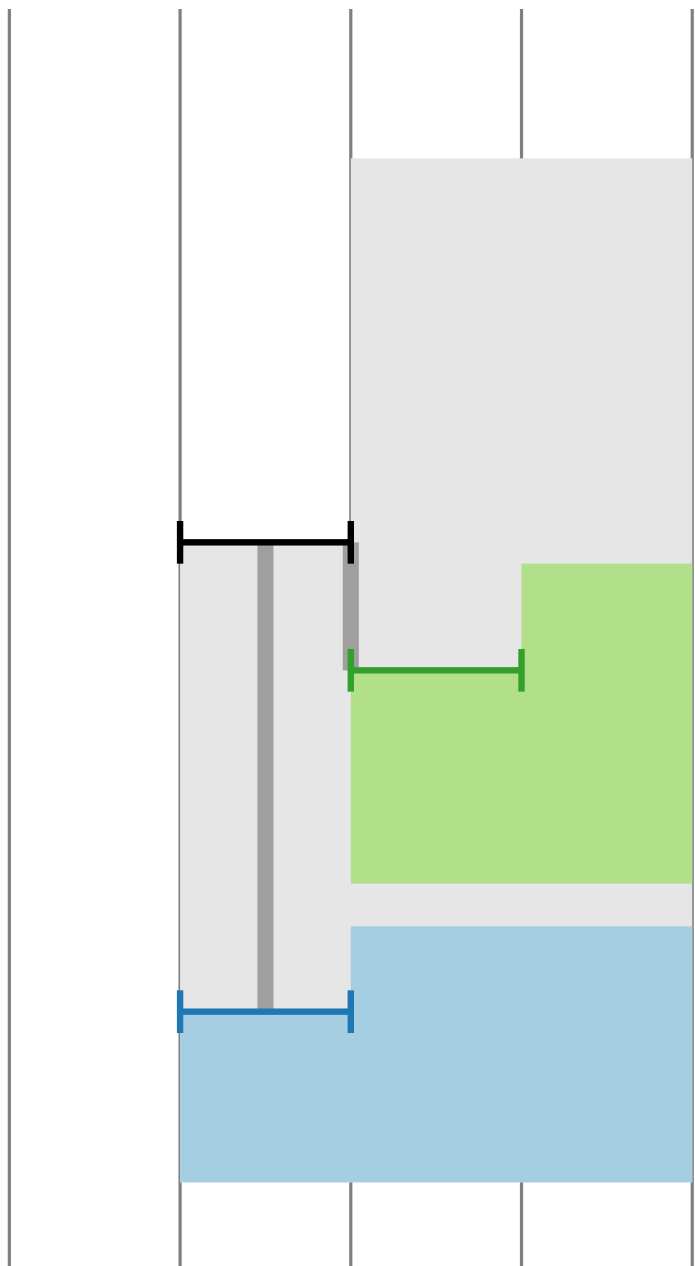

Weak: Trees, maxdeg 4

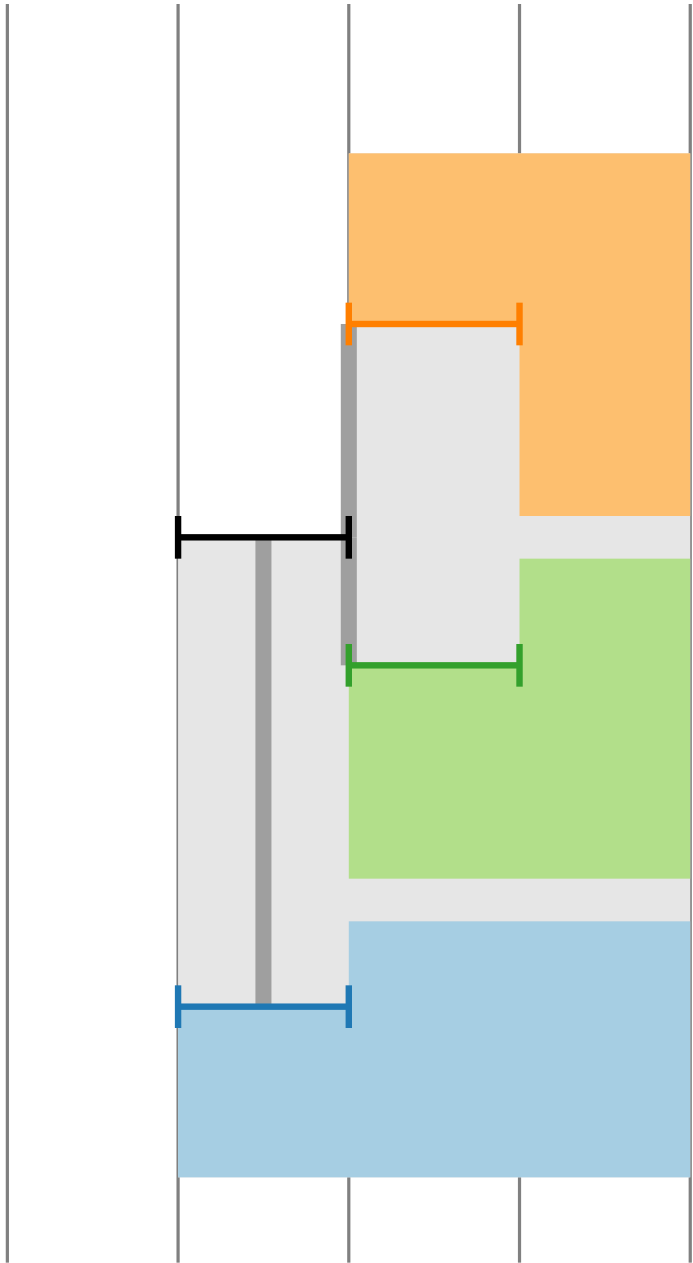

Weak: Trees, maxdeg 4

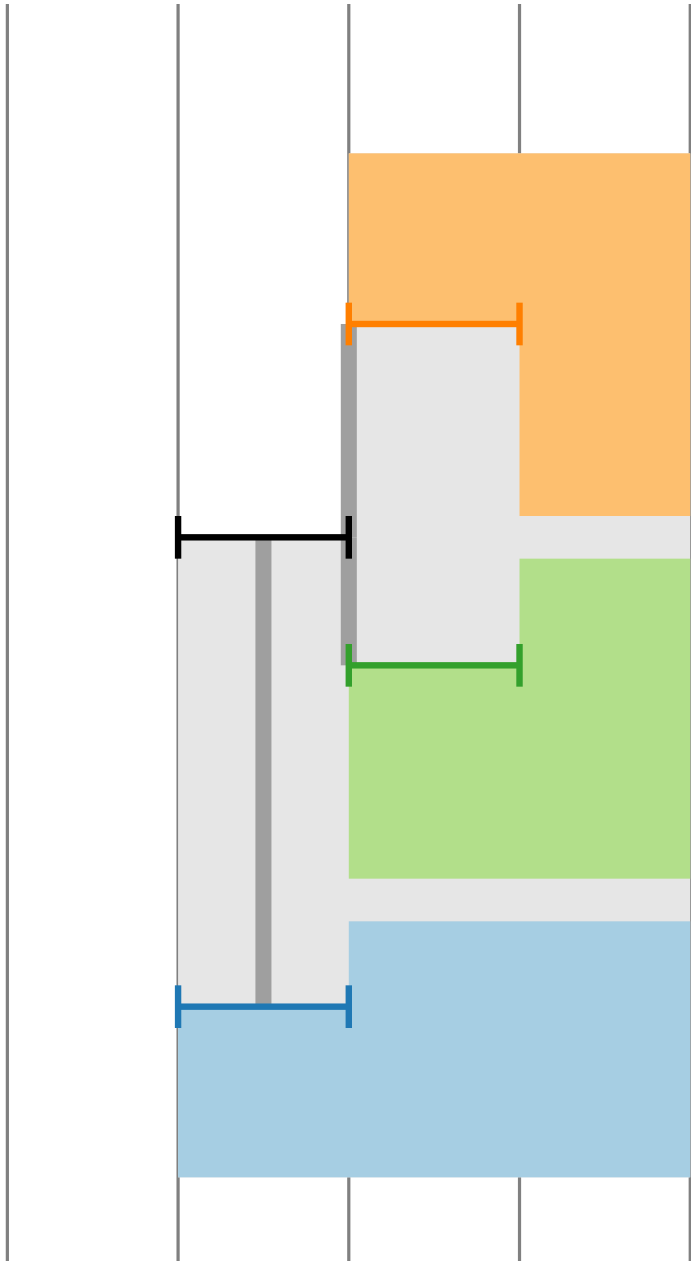

Tree with maxdeg 4 ✓

Weak: Biconnected Outerplanar, maxdeg 3

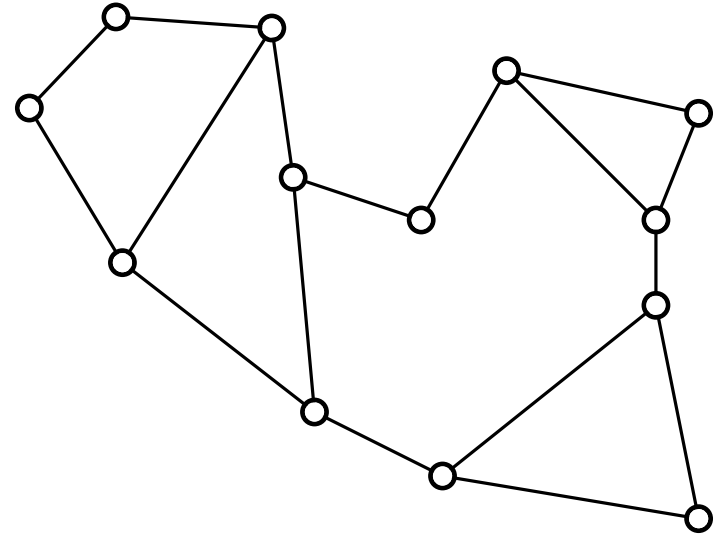
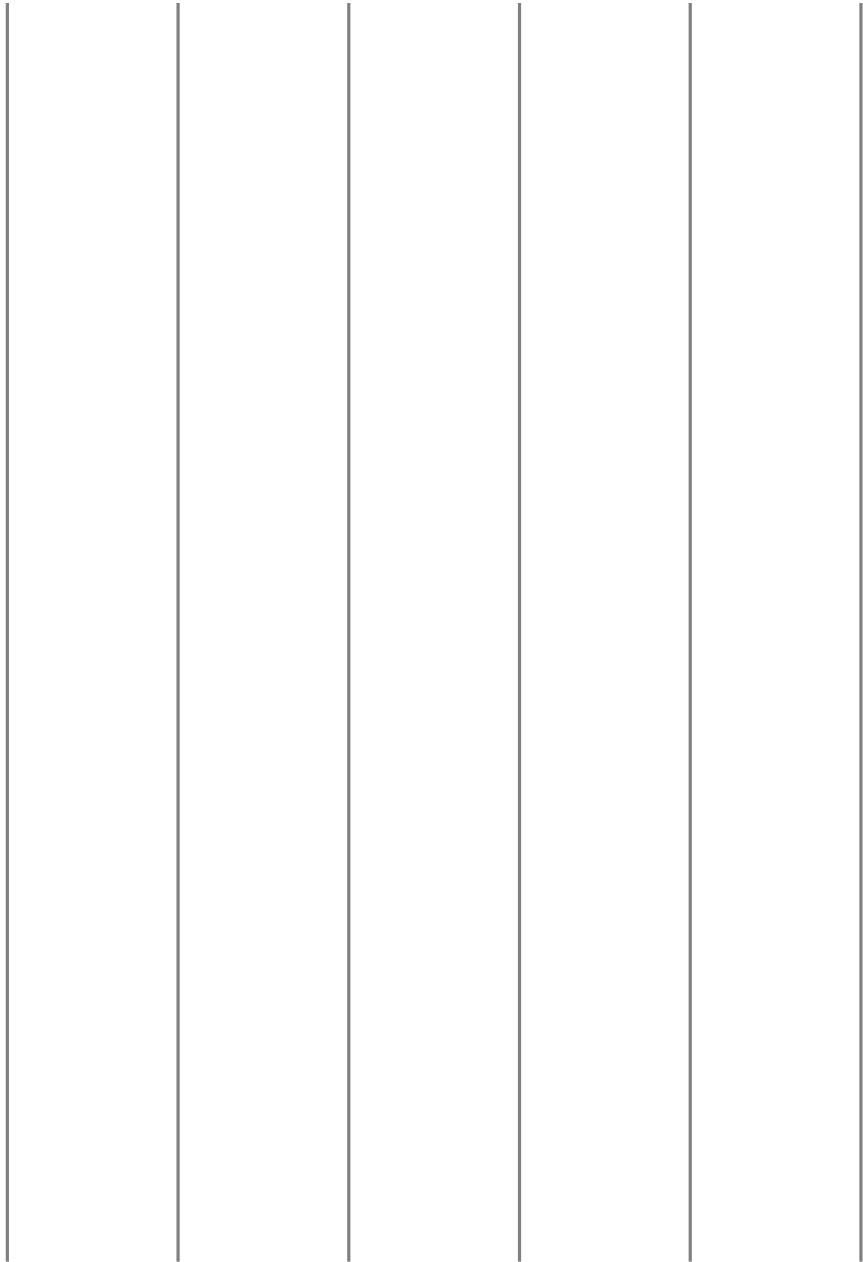

Weak: Biconnected Outerplanar, maxdeg 3

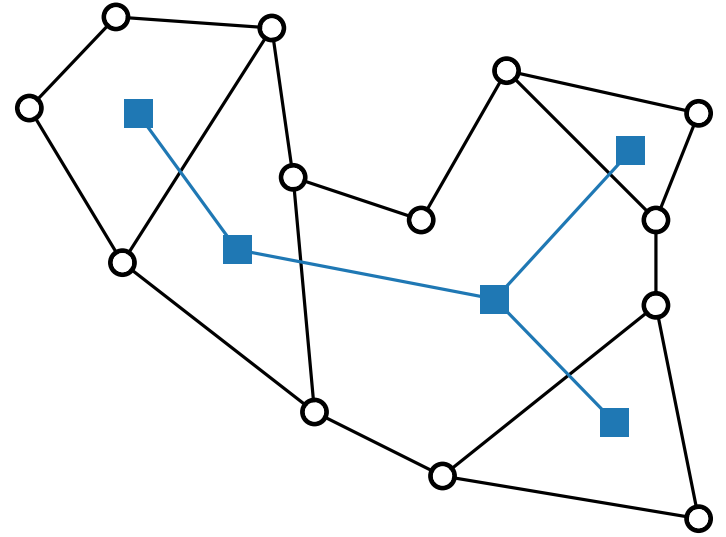
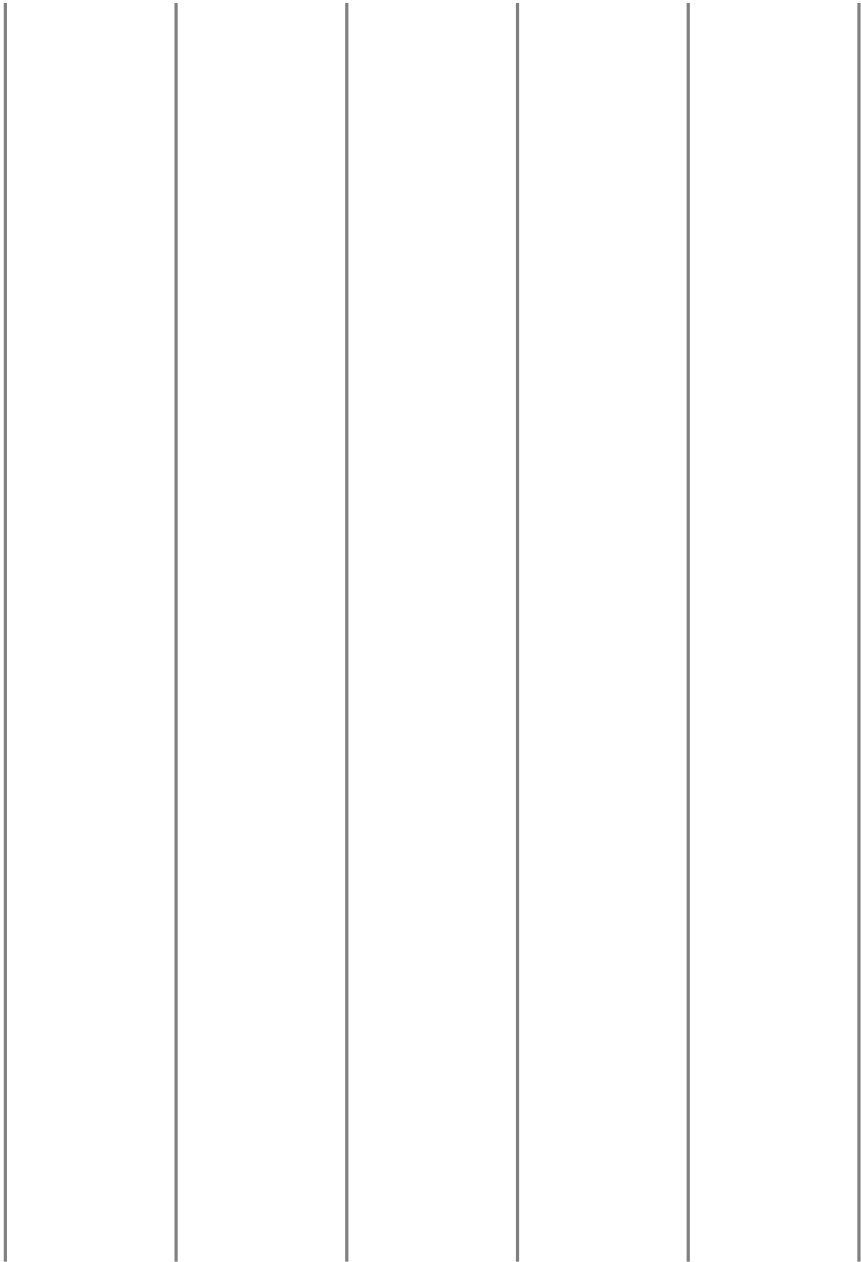

Weak: Biconnected Outerplanar, maxdeg 3

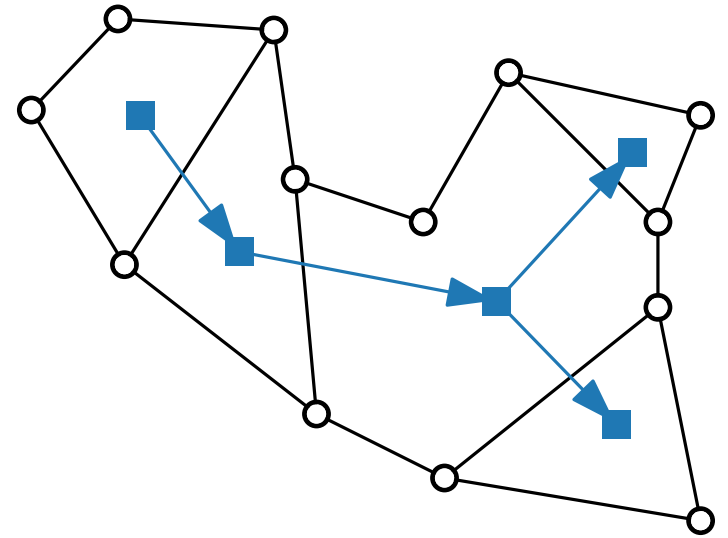
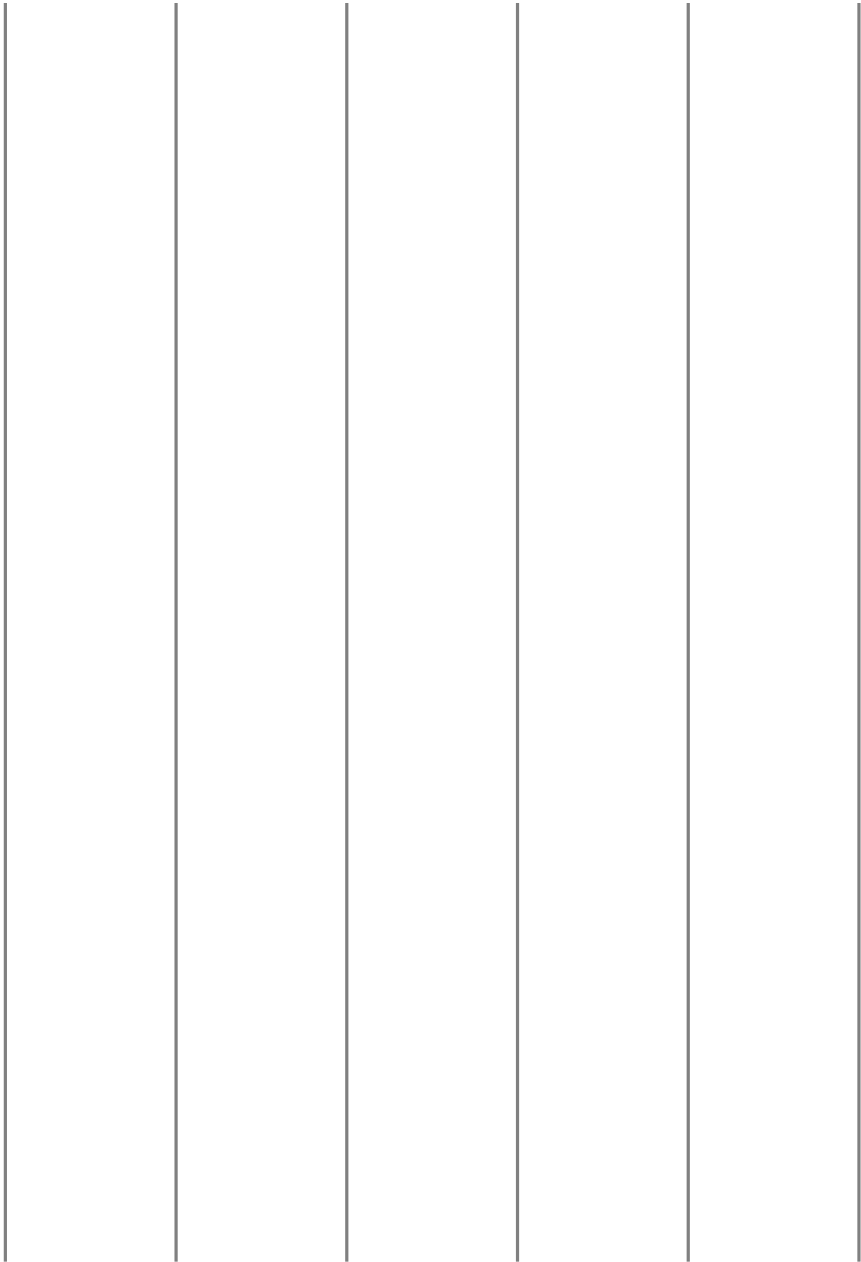

Weak: Biconnected Outerplanar, maxdeg 3

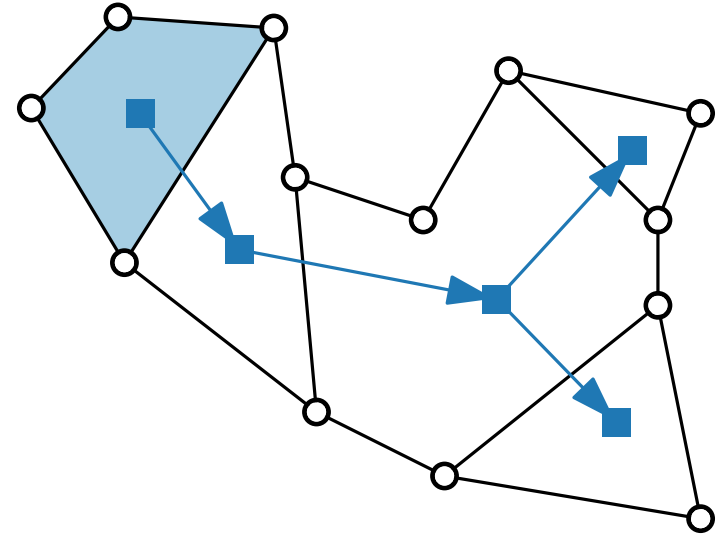
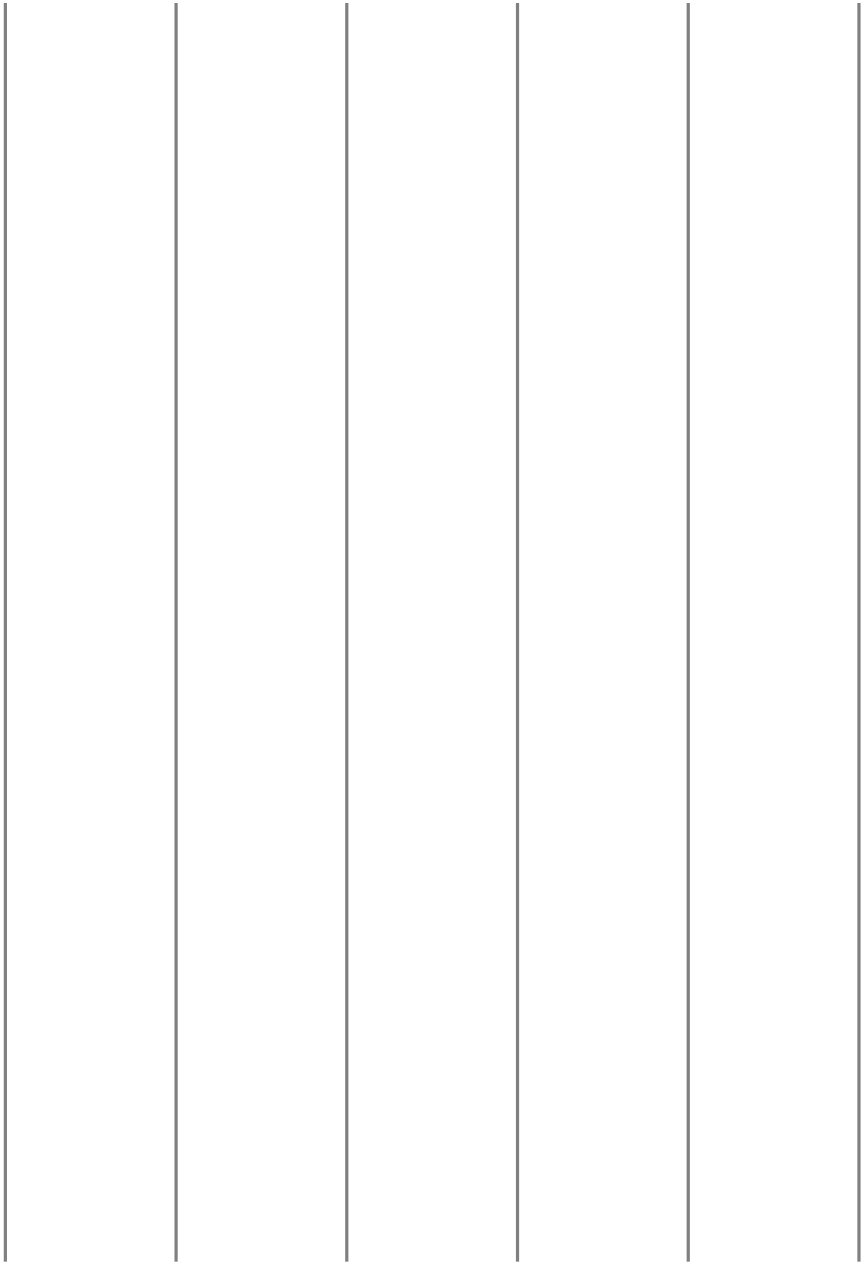

Weak: Biconnected Outerplanar, maxdeg 3

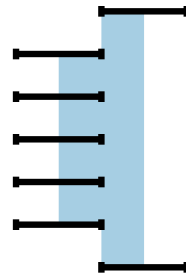
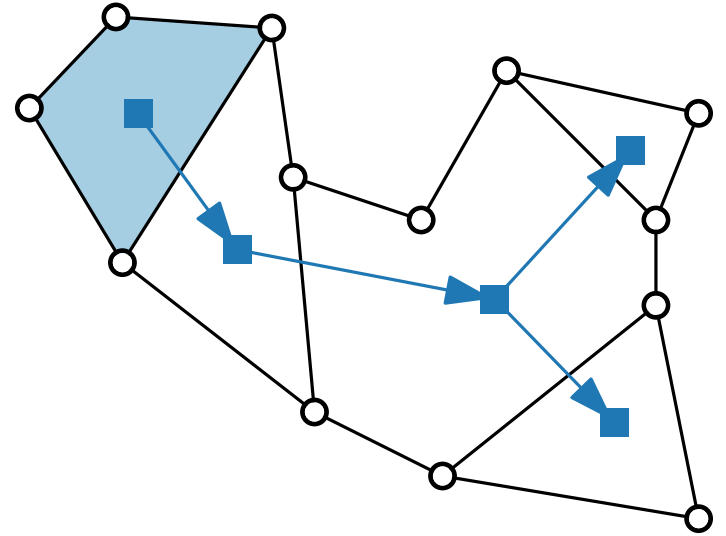
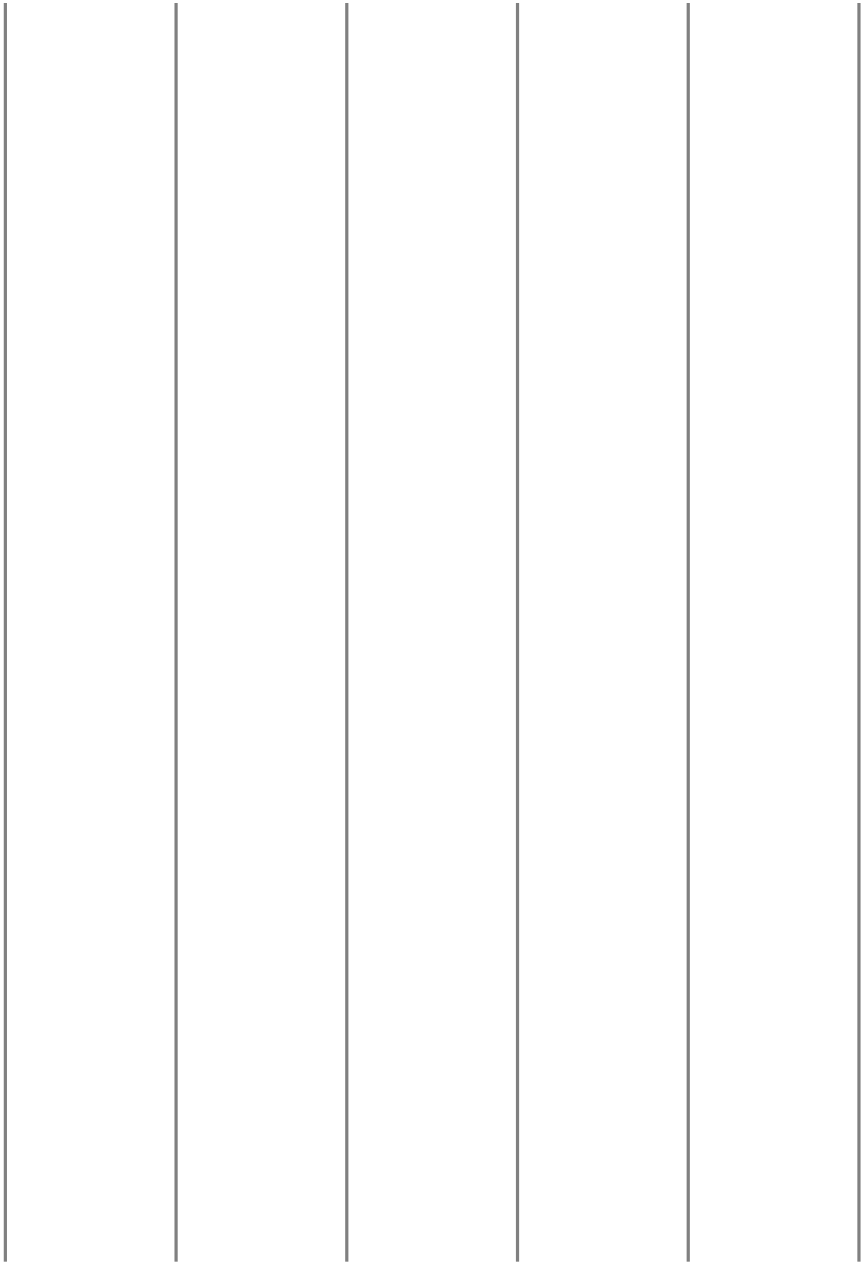

Weak: Biconnected Outerplanar, maxdeg 3

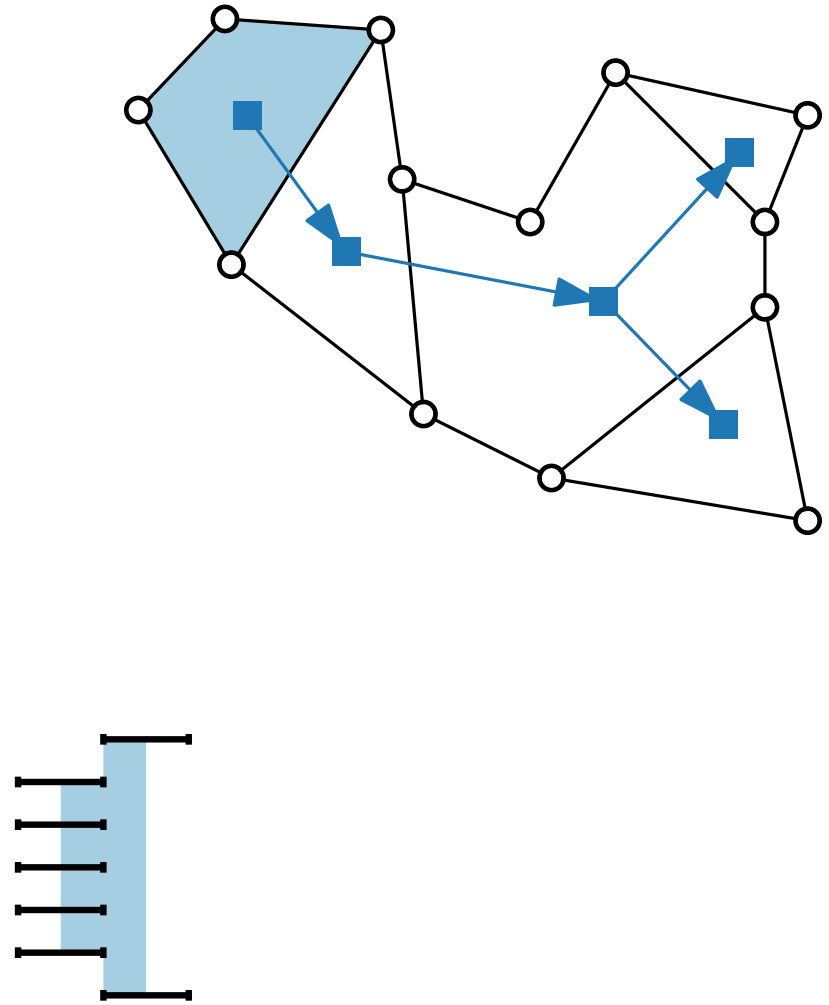
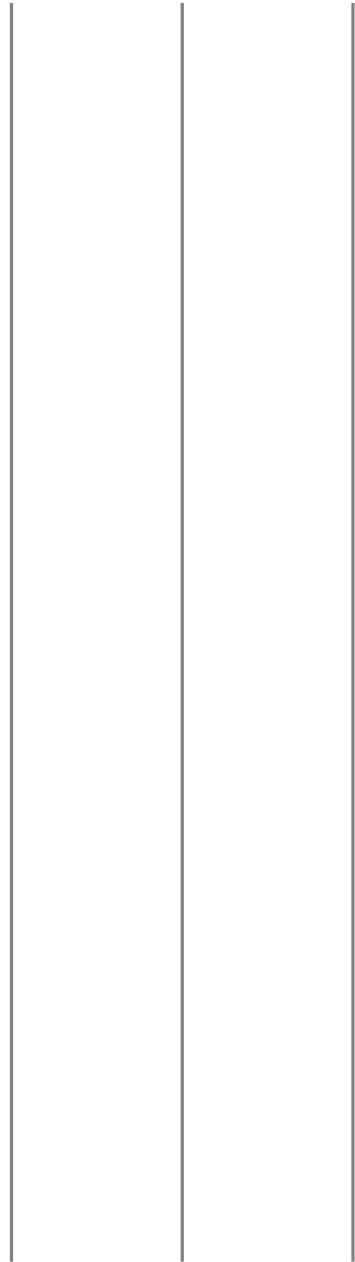
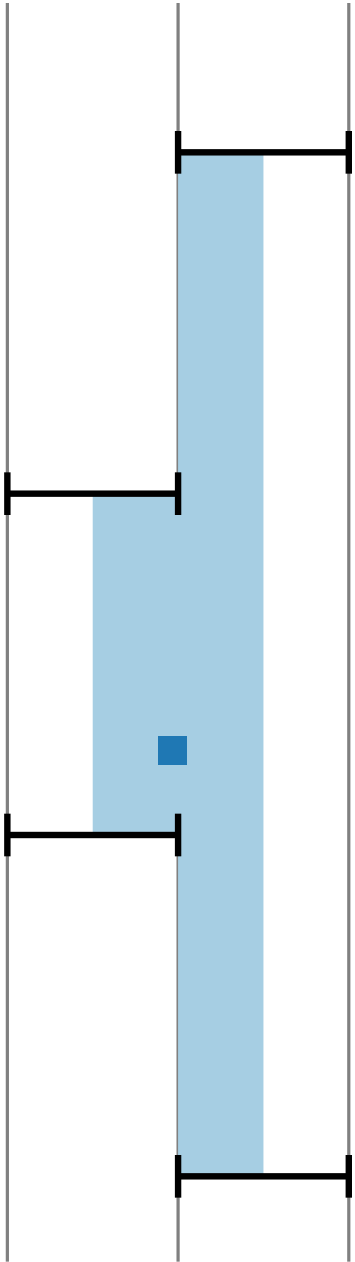

Weak: Biconnected Outerplanar, maxdeg 3

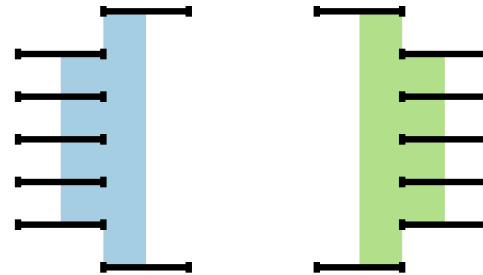
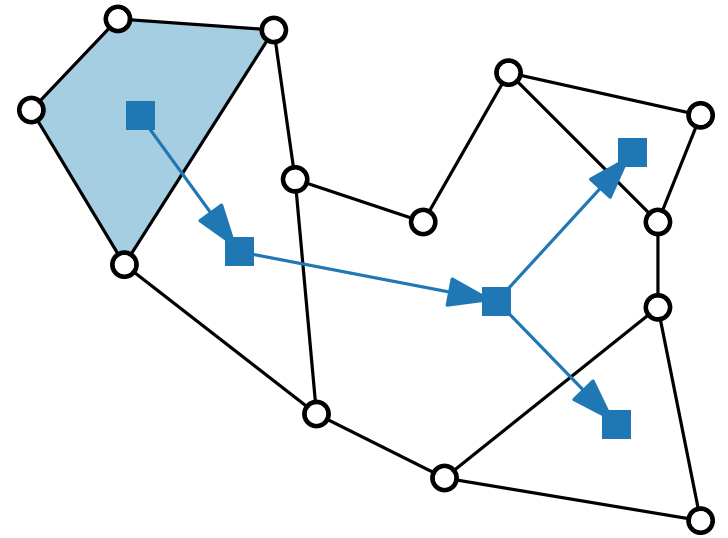
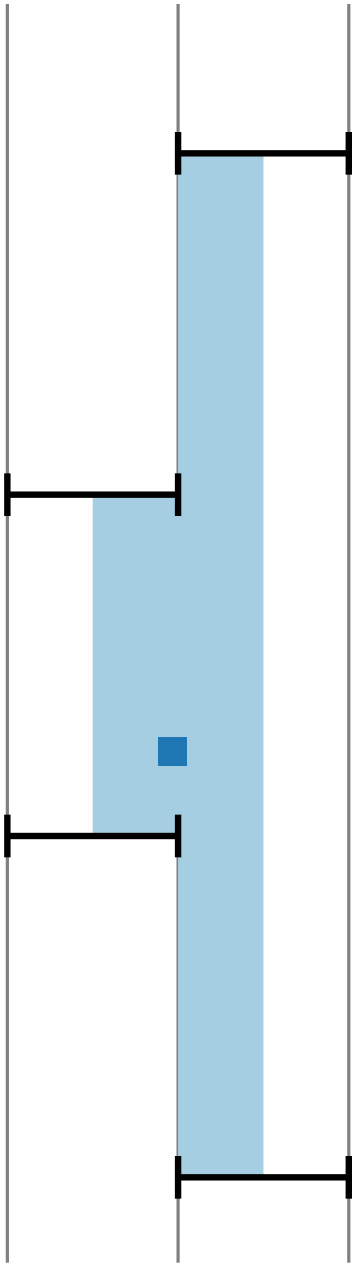

Weak: Biconnected Outerplanar, maxdeg 3

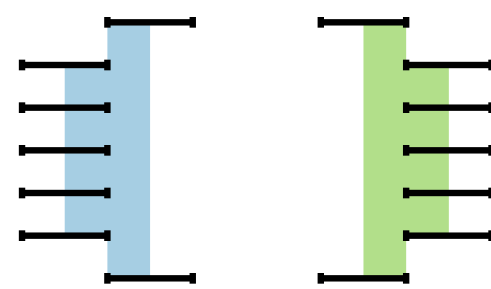
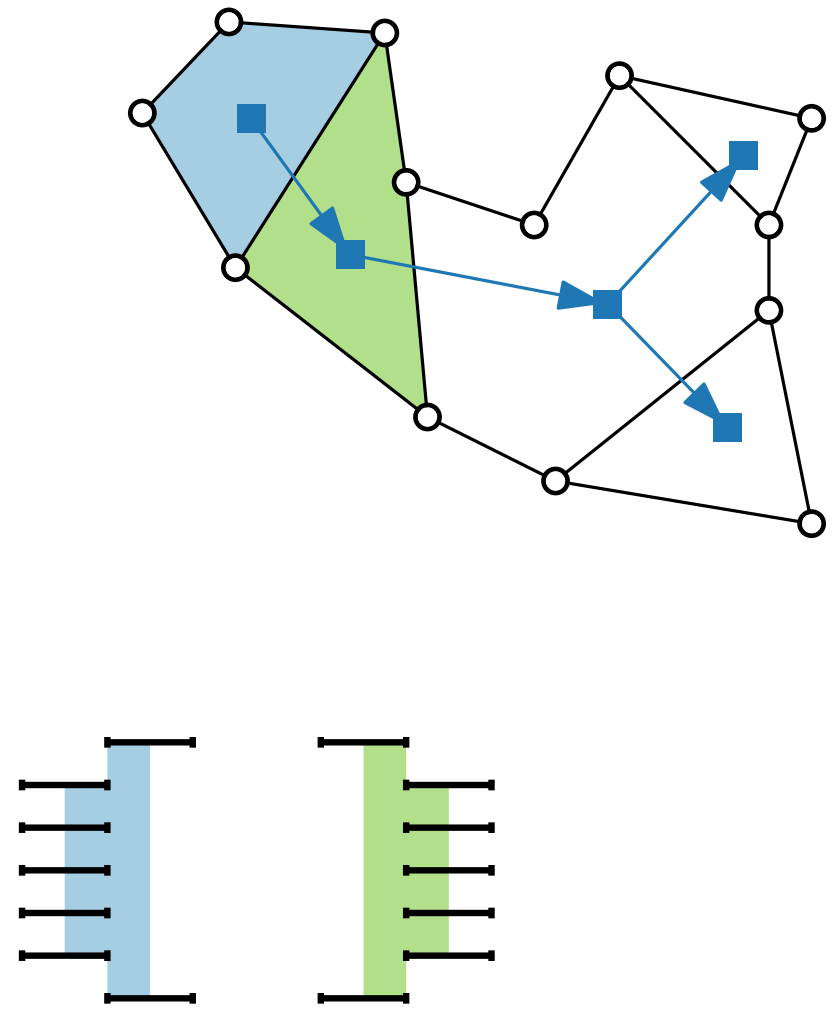
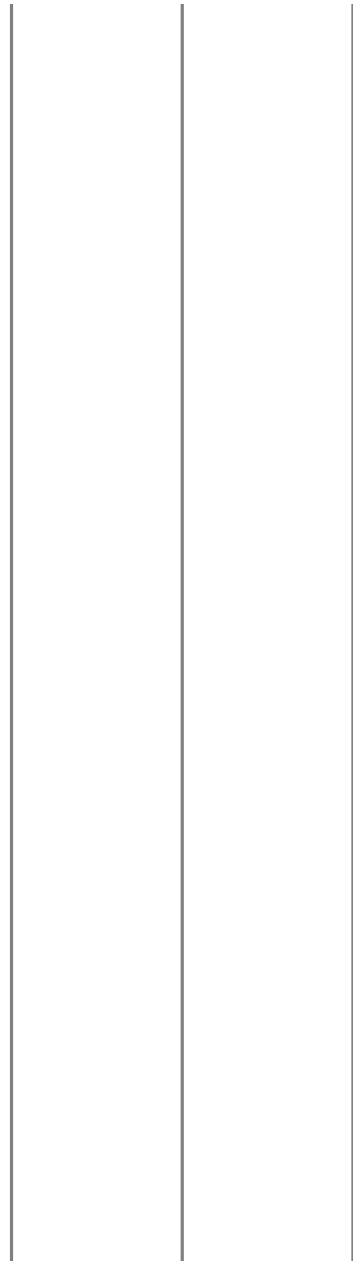
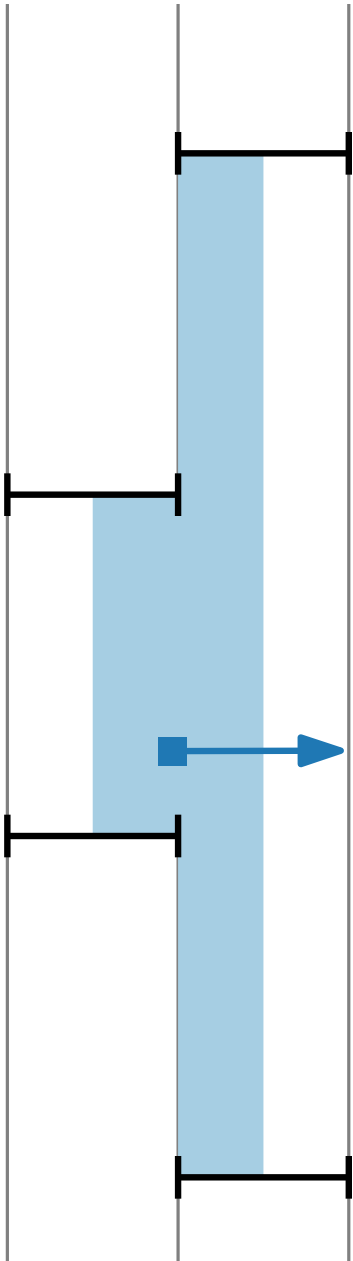

Weak: Biconnected Outerplanar, maxdeg 3

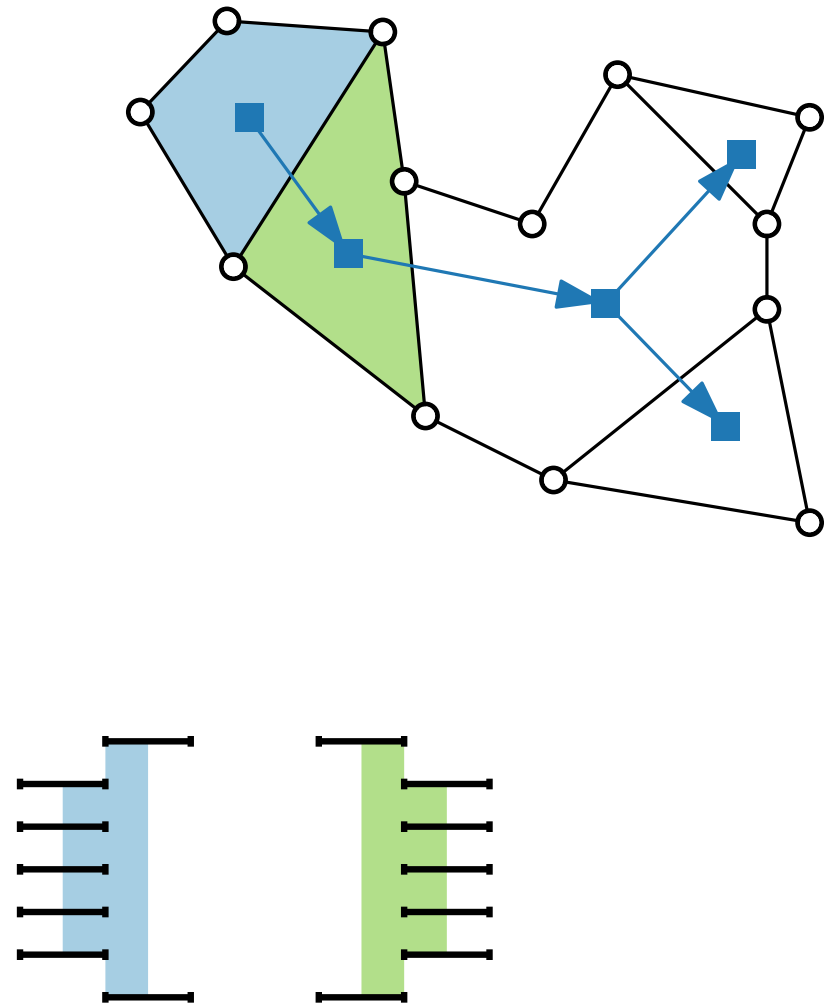
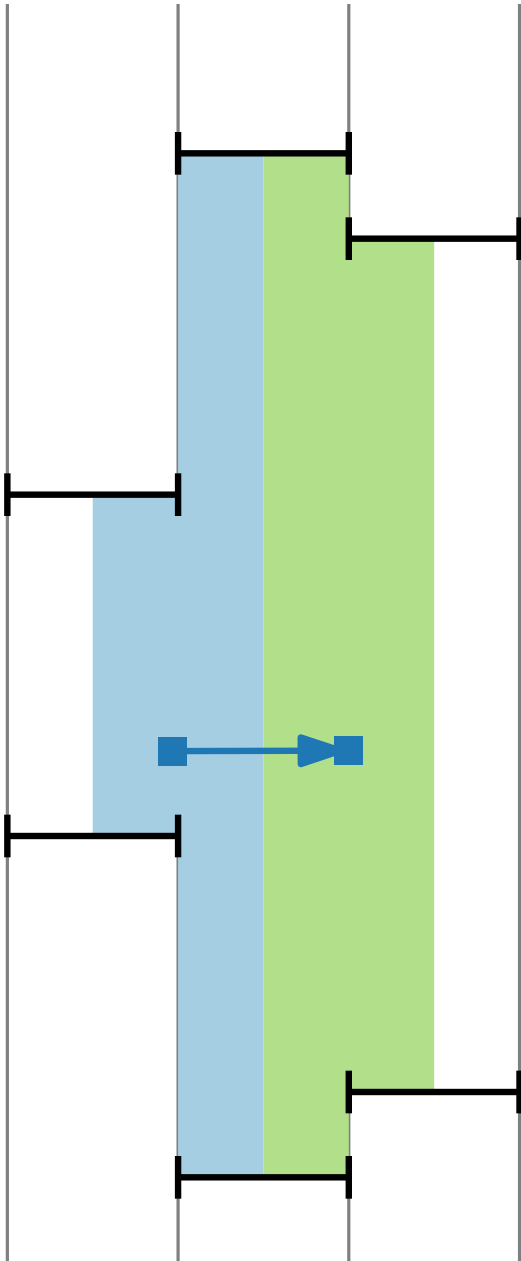

Weak: Biconnected Outerplanar, maxdeg 3

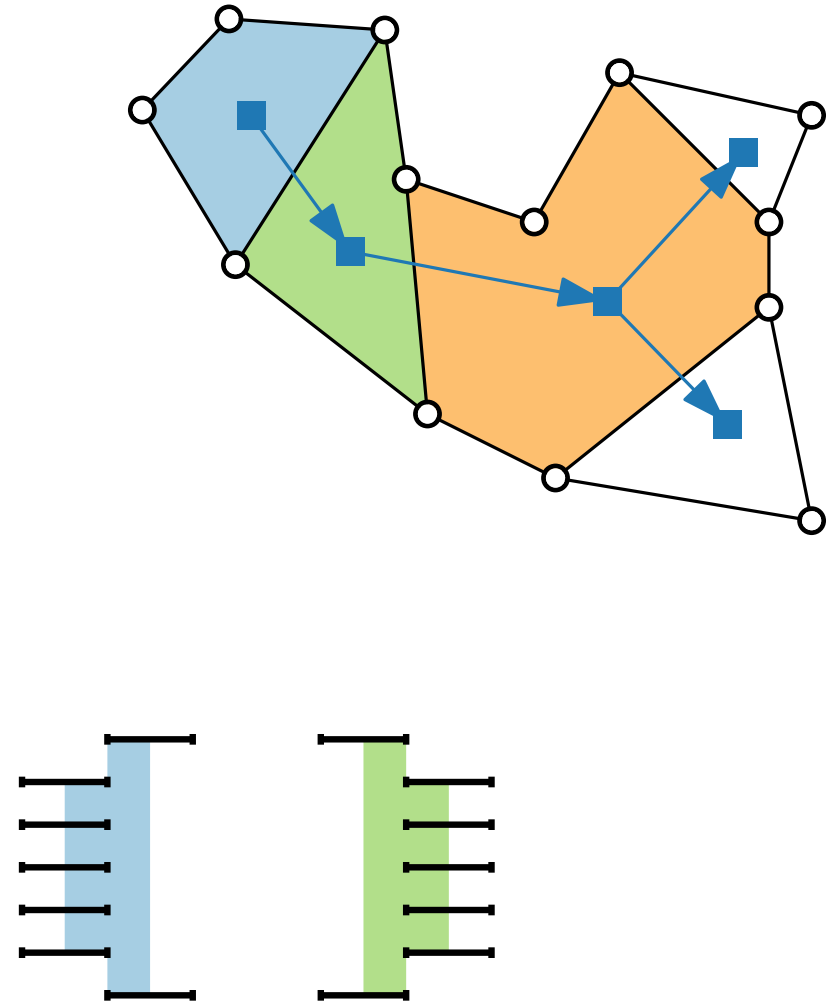
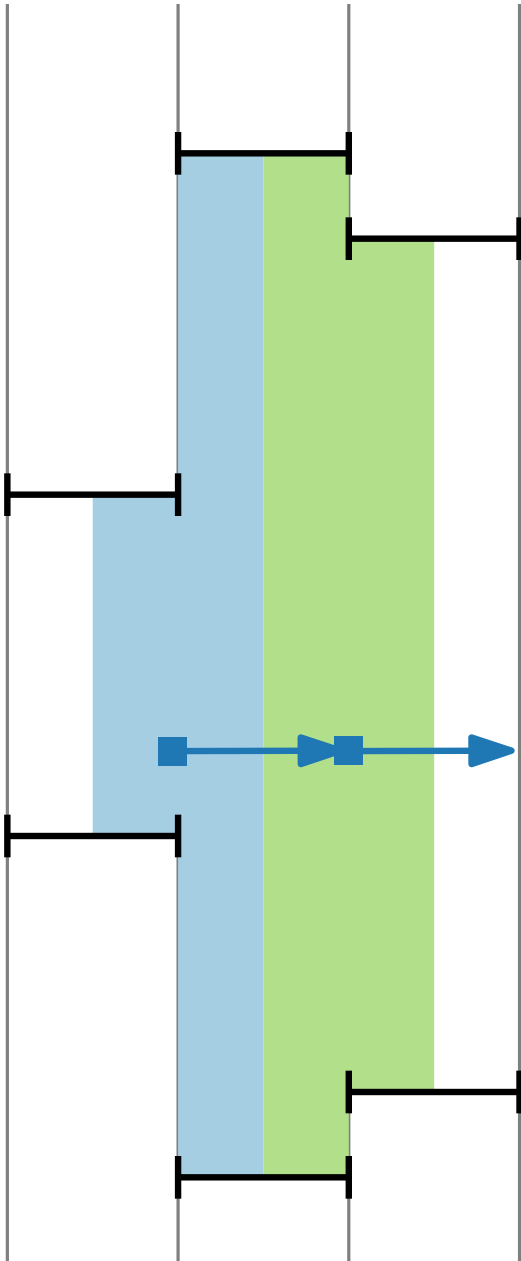

Weak: Biconnected Outerplanar, maxdeg 3

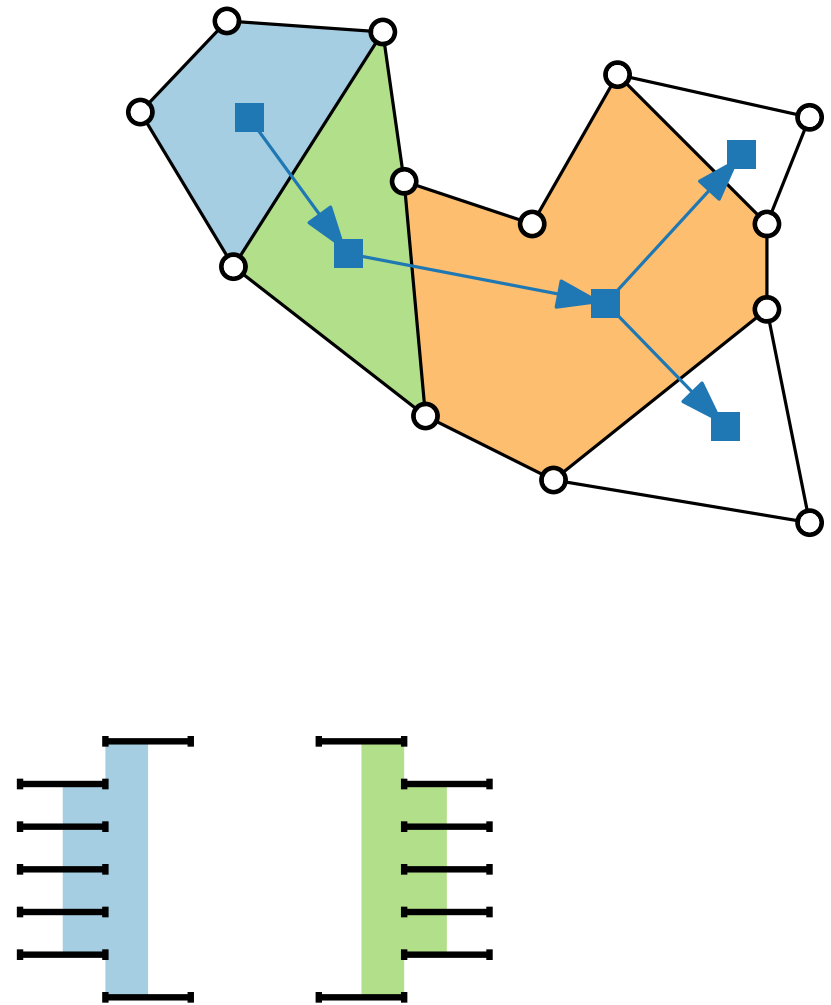
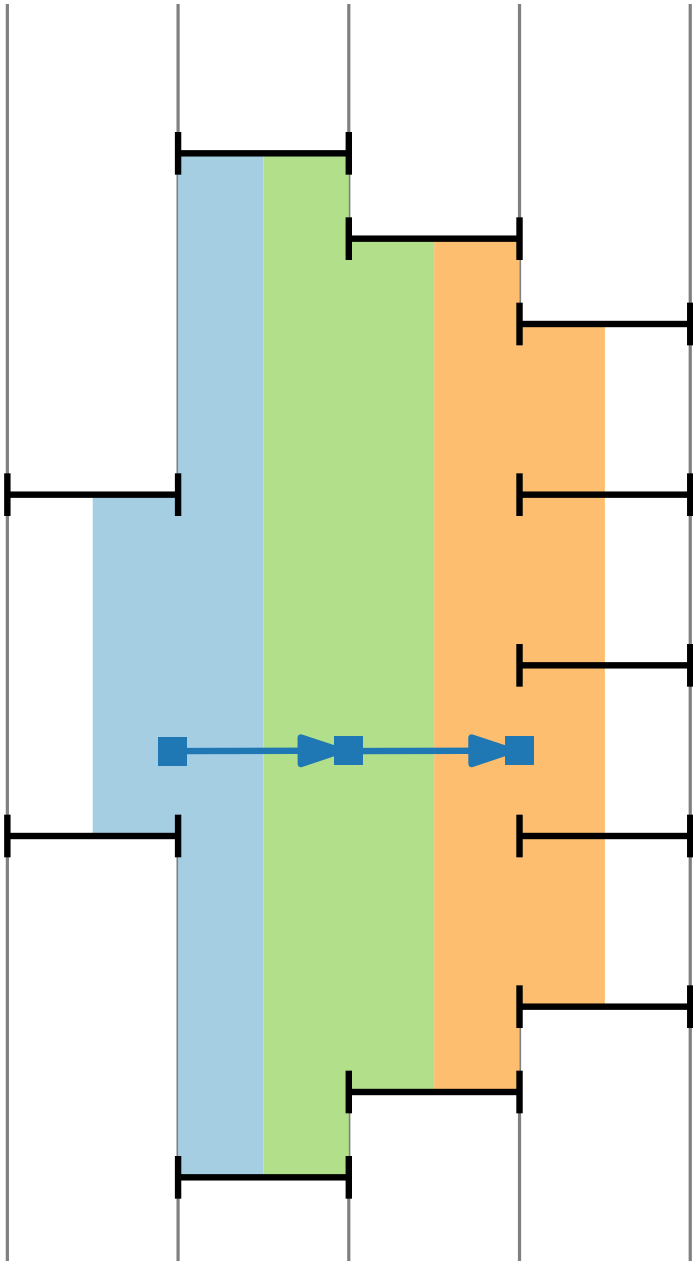

Weak: Biconnected Outerplanar, maxdeg 3

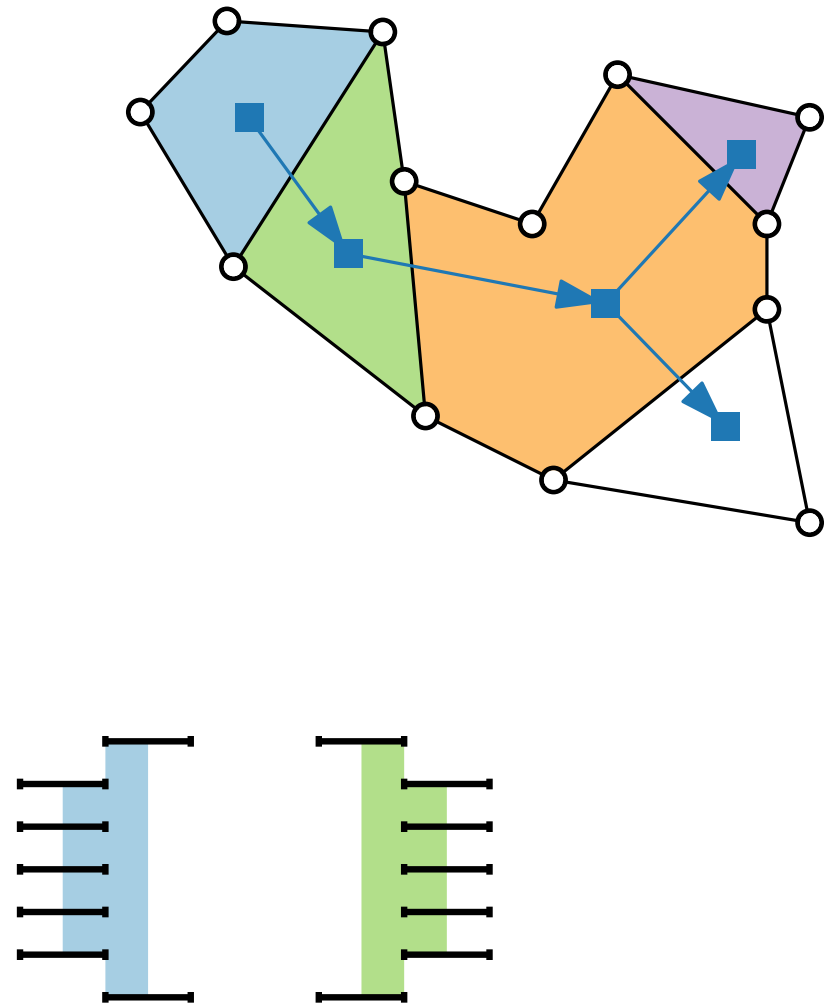
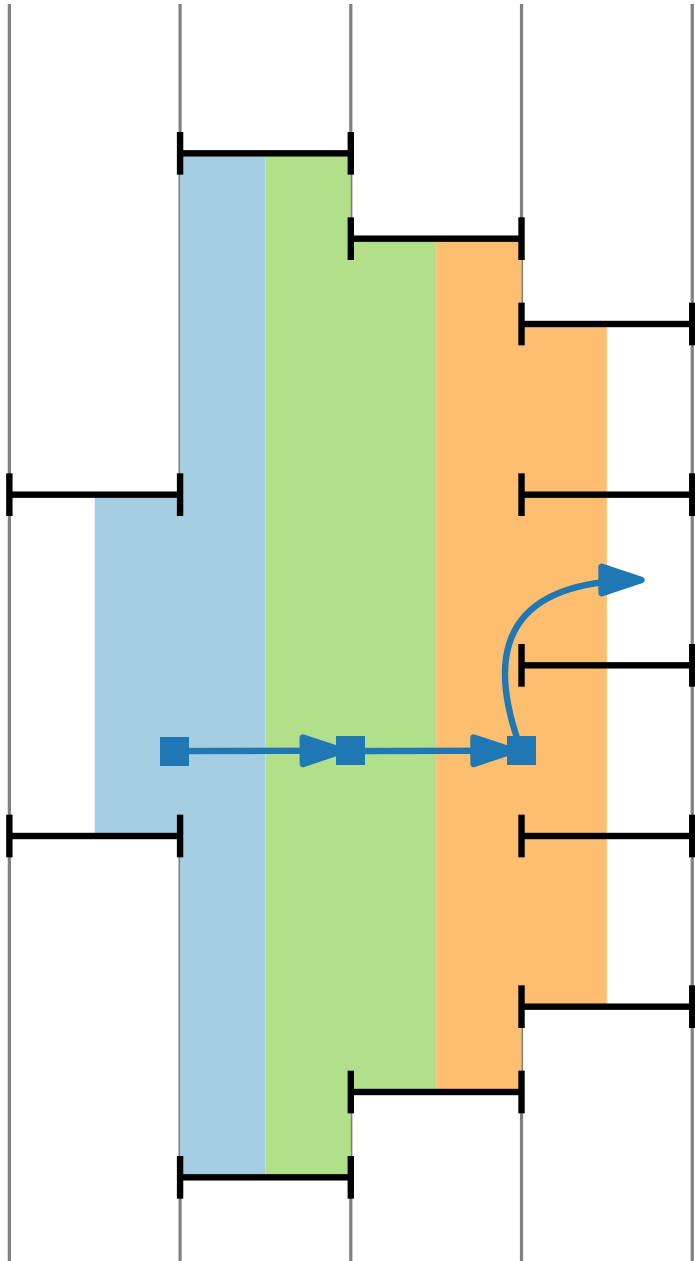

Weak: Biconnected Outerplanar, maxdeg 3

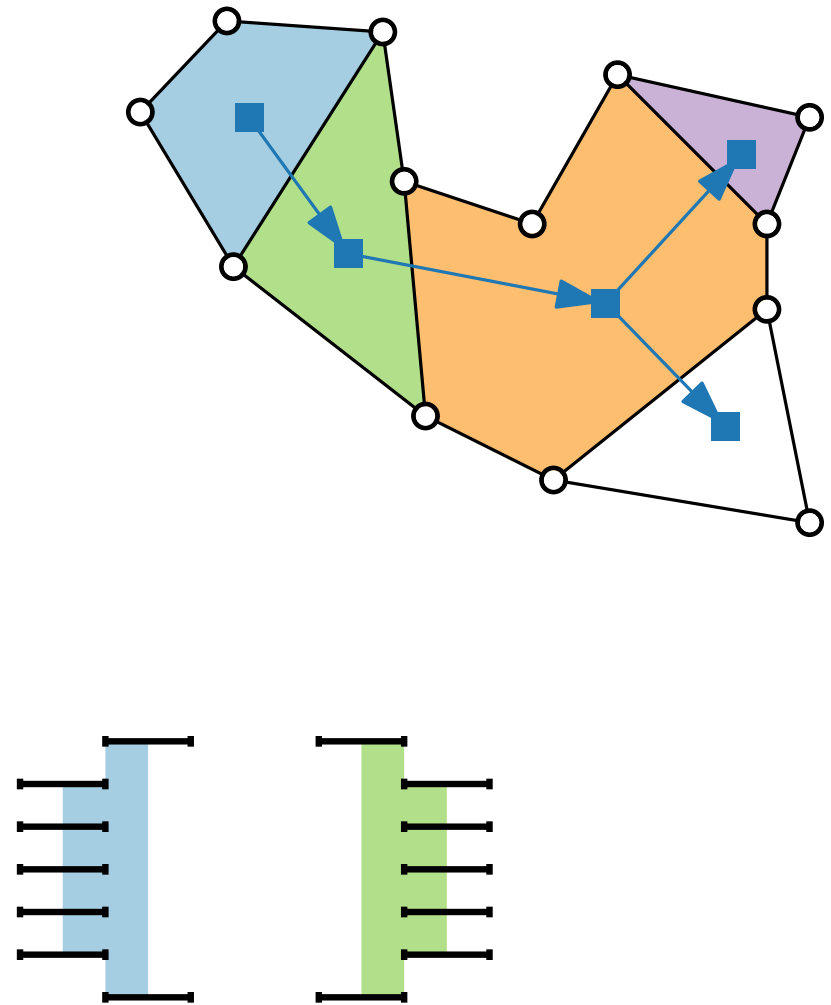
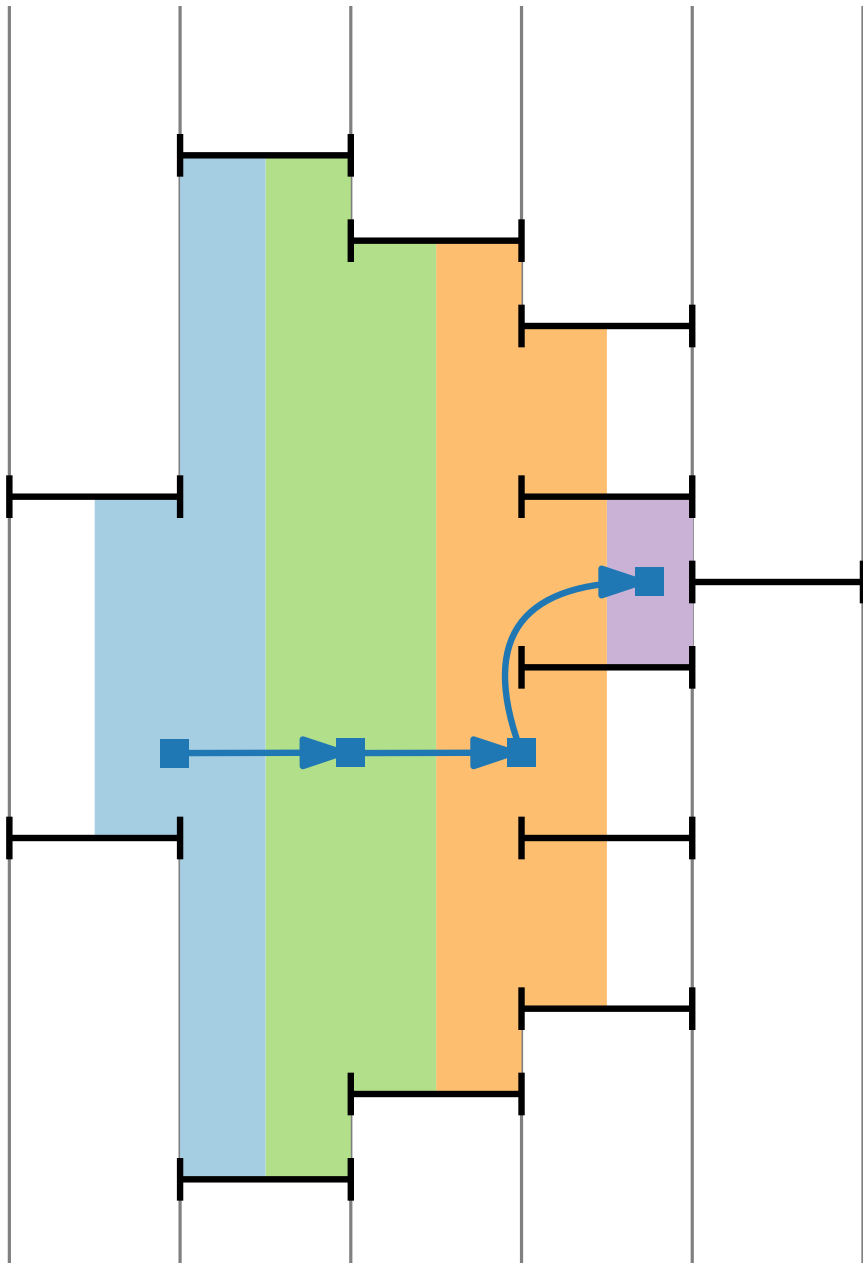

Weak: Biconnected Outerplanar, maxdeg 3

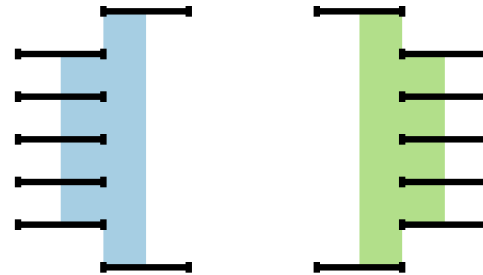
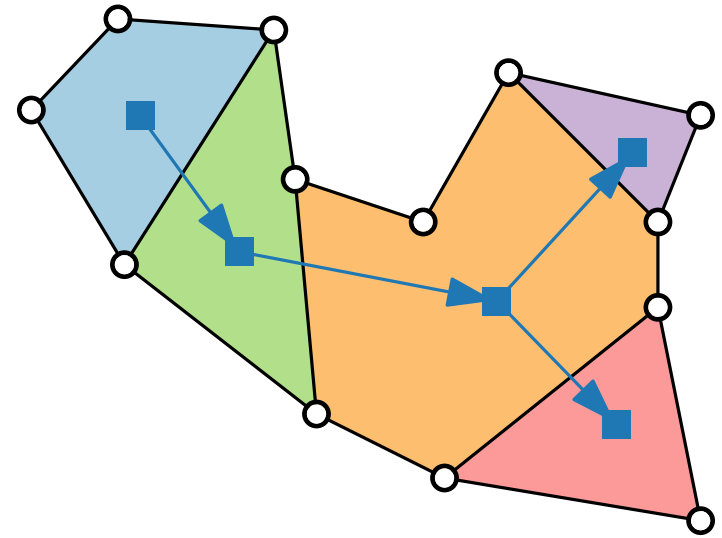
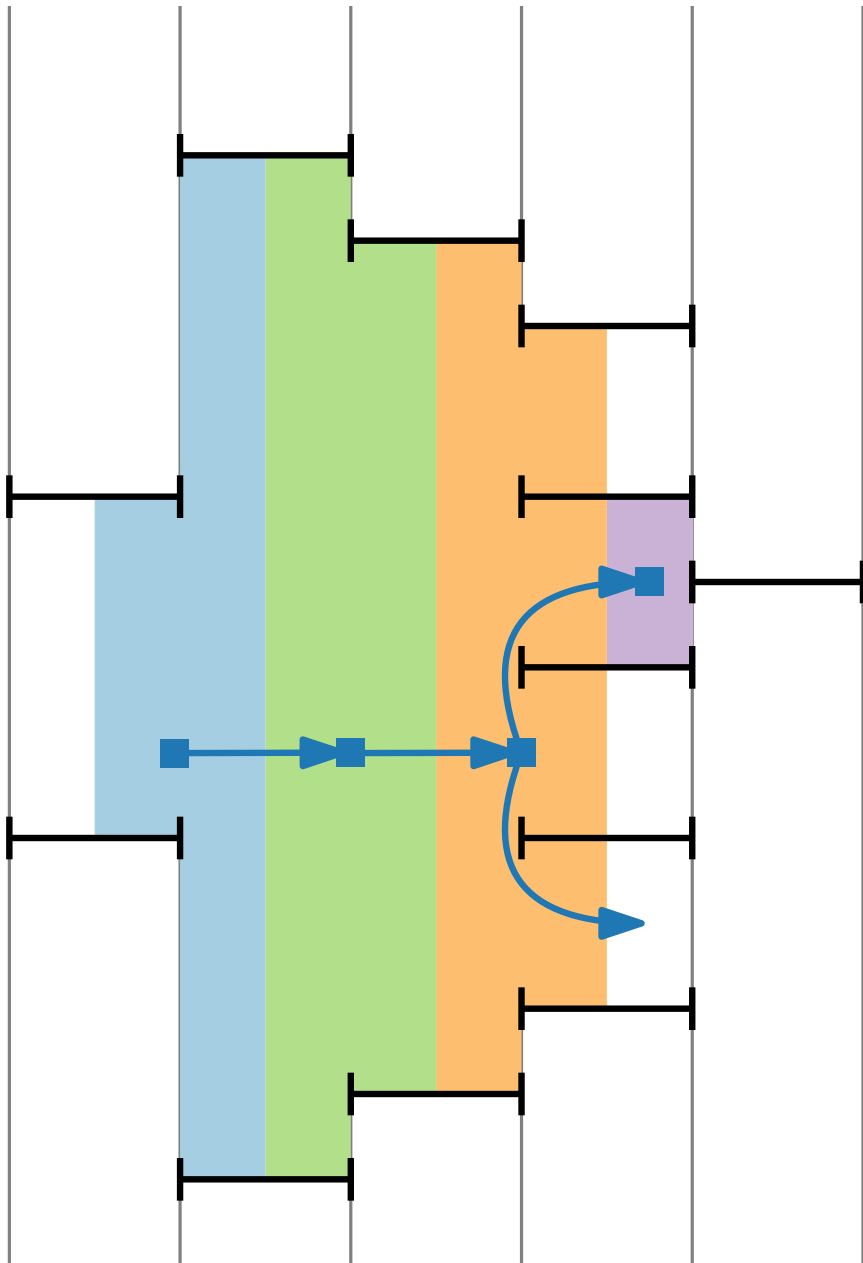

Weak: Biconnected Outerplanar, maxdeg 3

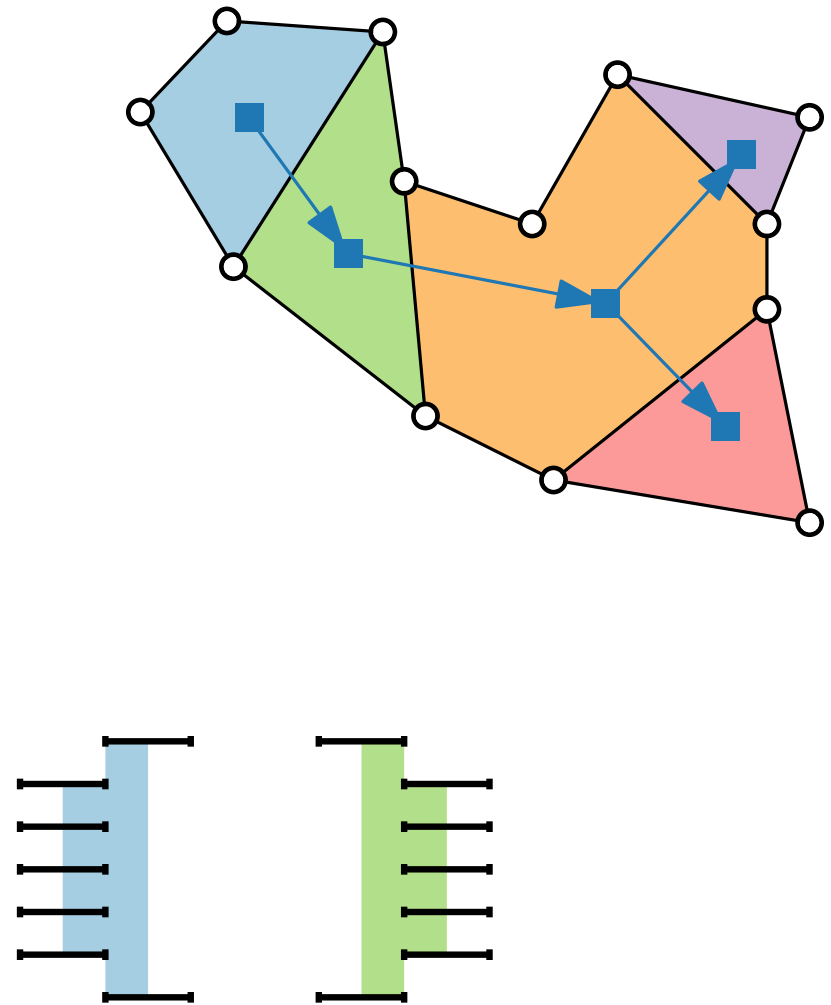
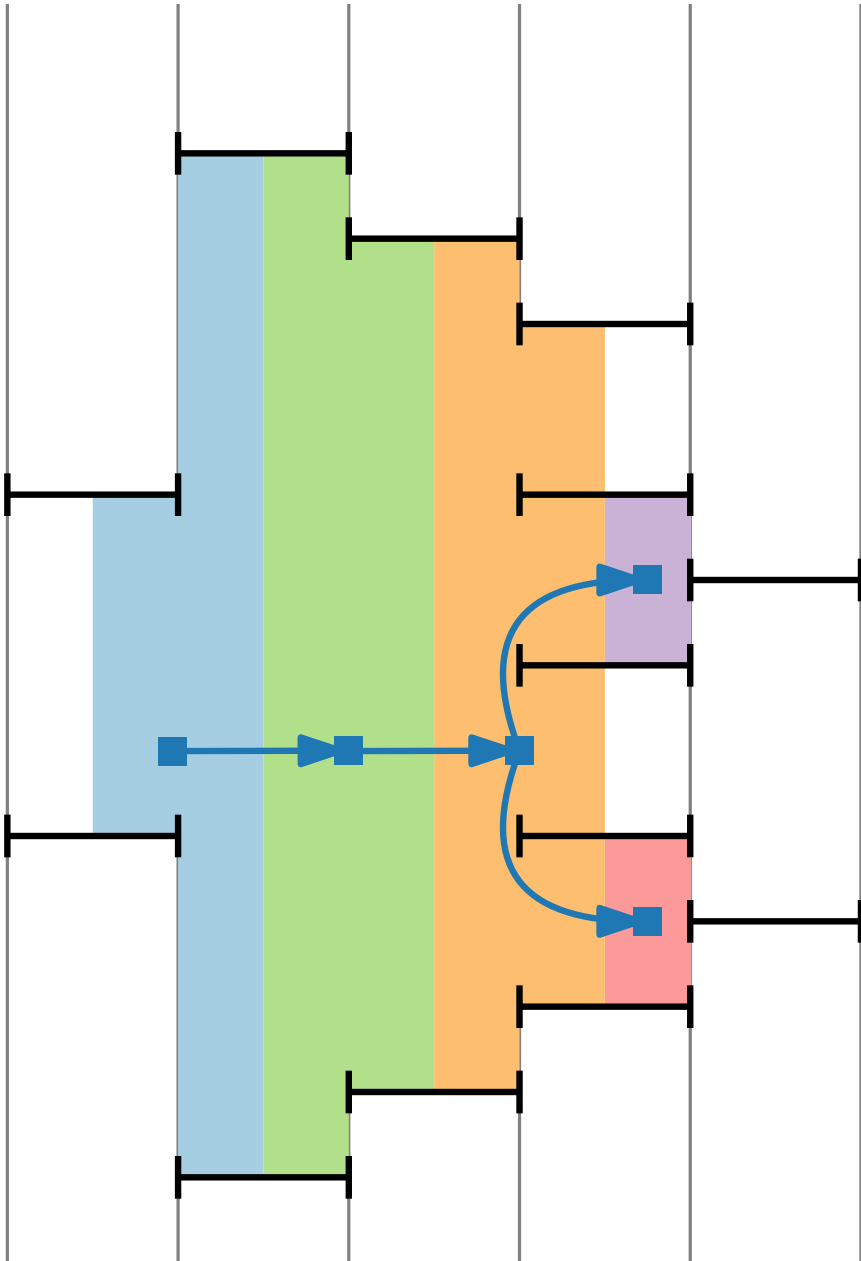

Weak: Biconnected Outerplanar, maxdeg 3

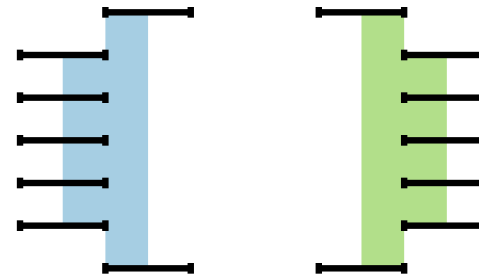
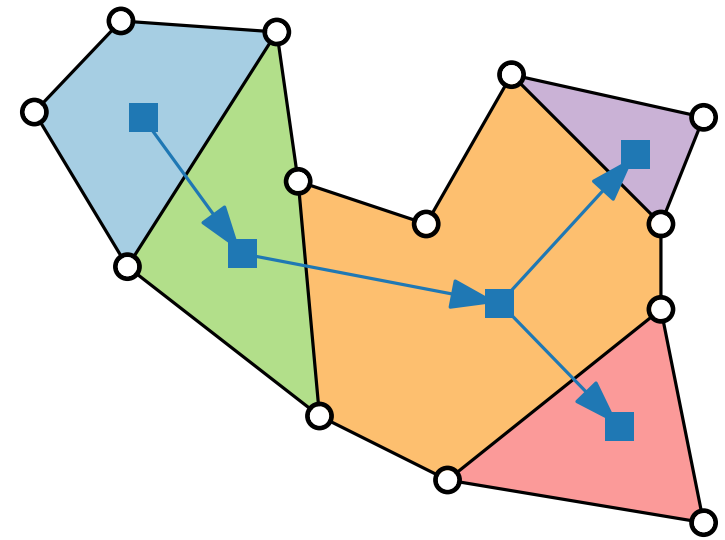
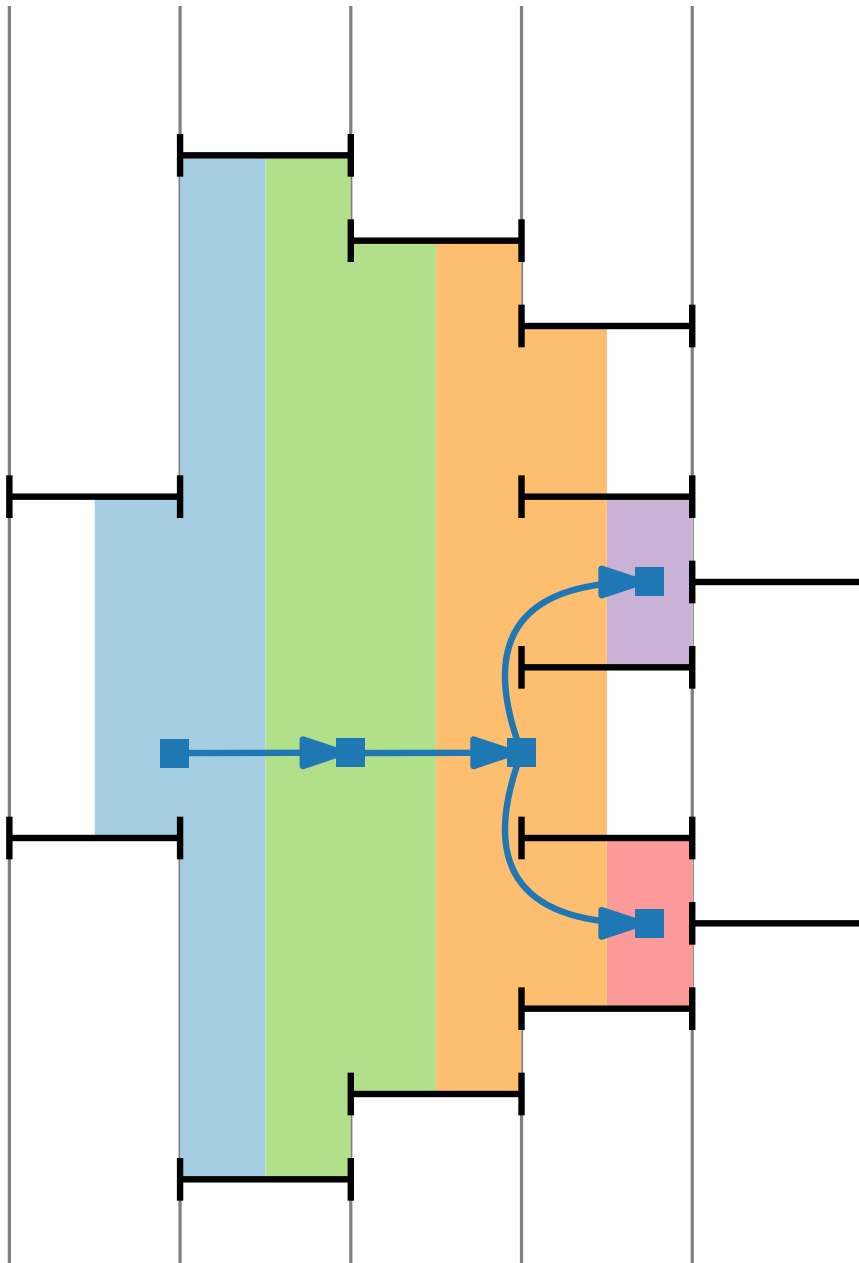

Biconnected Outerplanar
with maxdeg 3 ✓

Weak: Biconnected Outerplanar, maxdeg 4

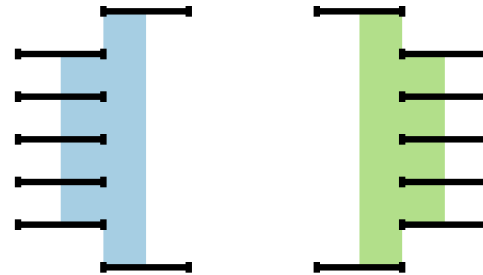
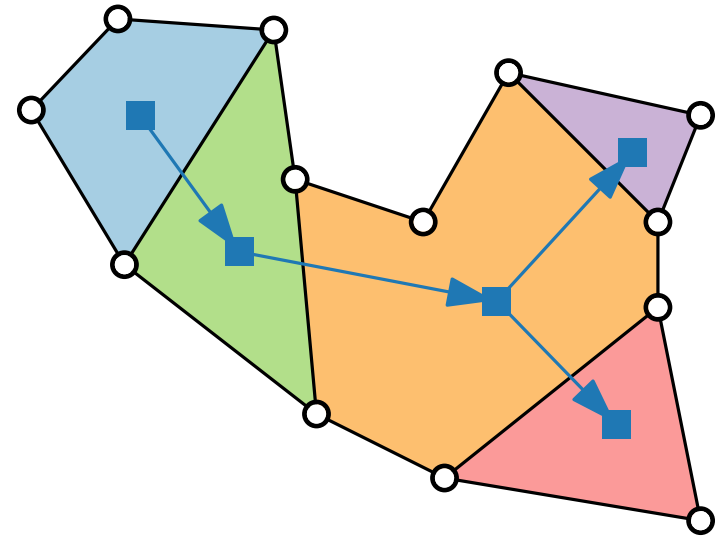
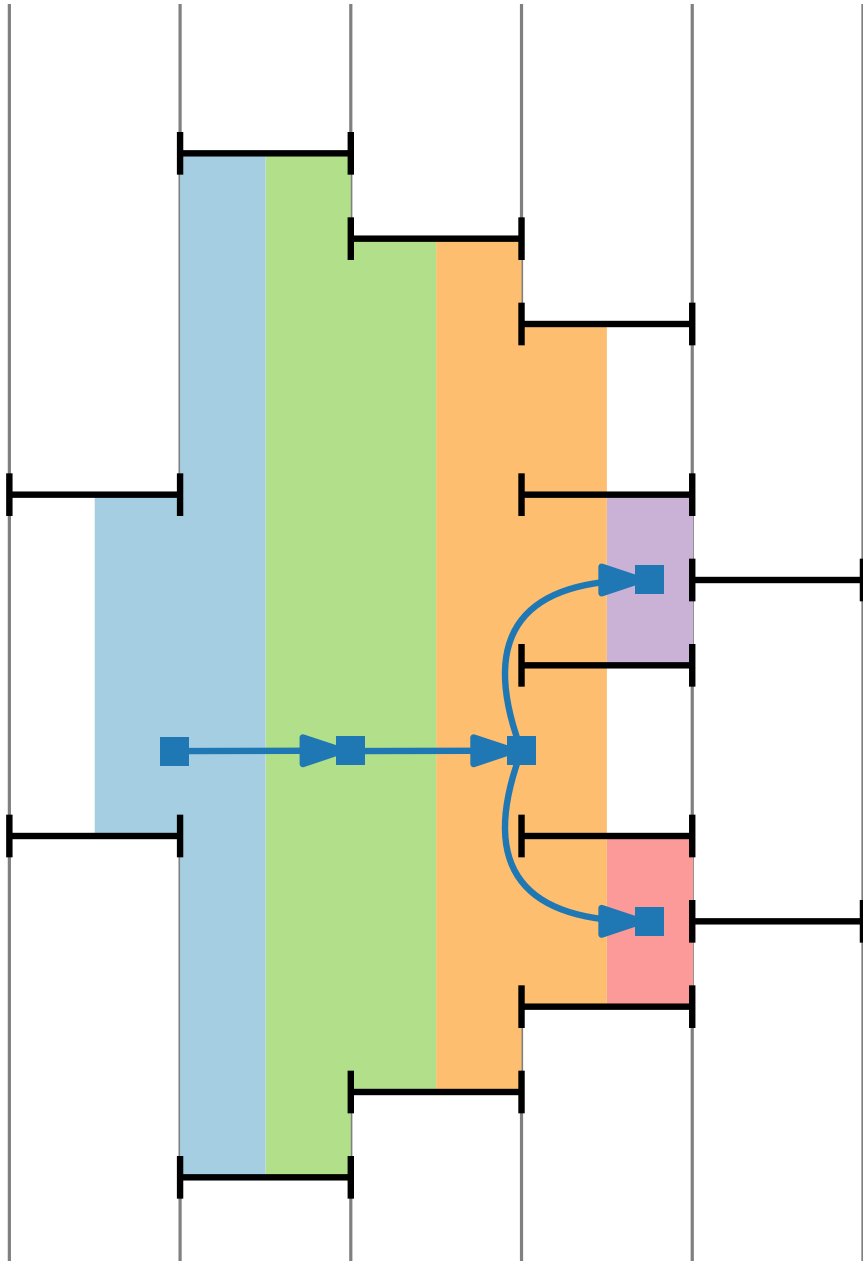

Weak: Biconnected Outerplanar, maxdeg 4

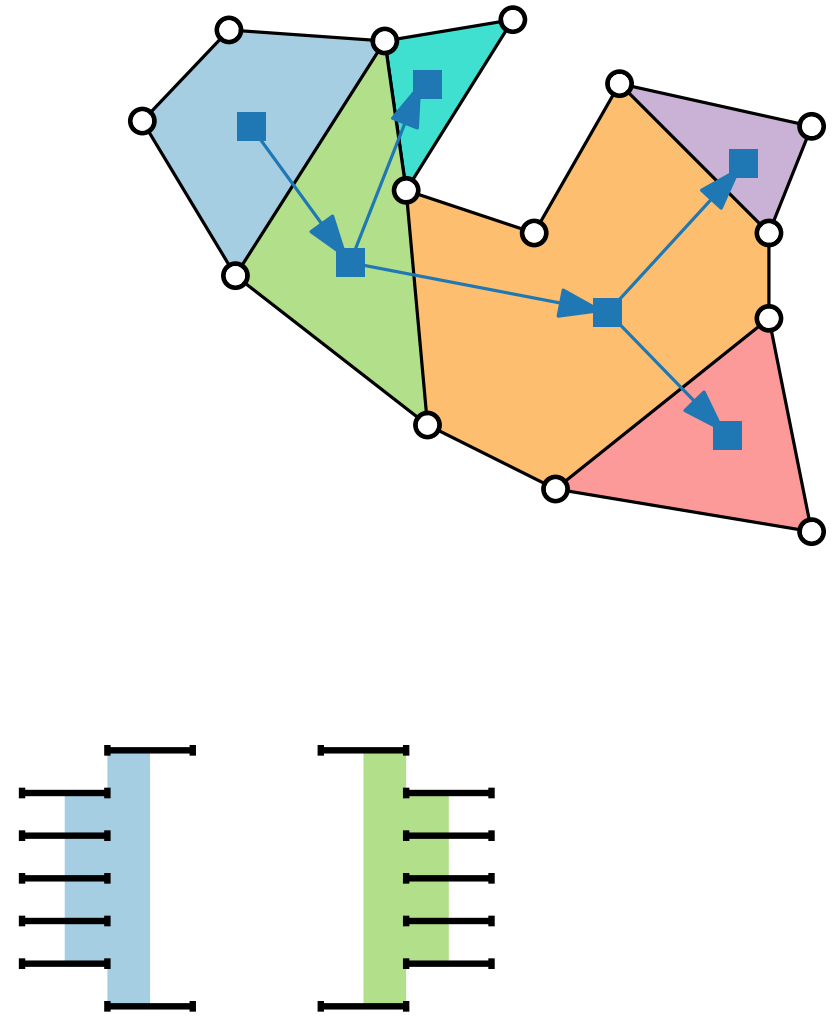
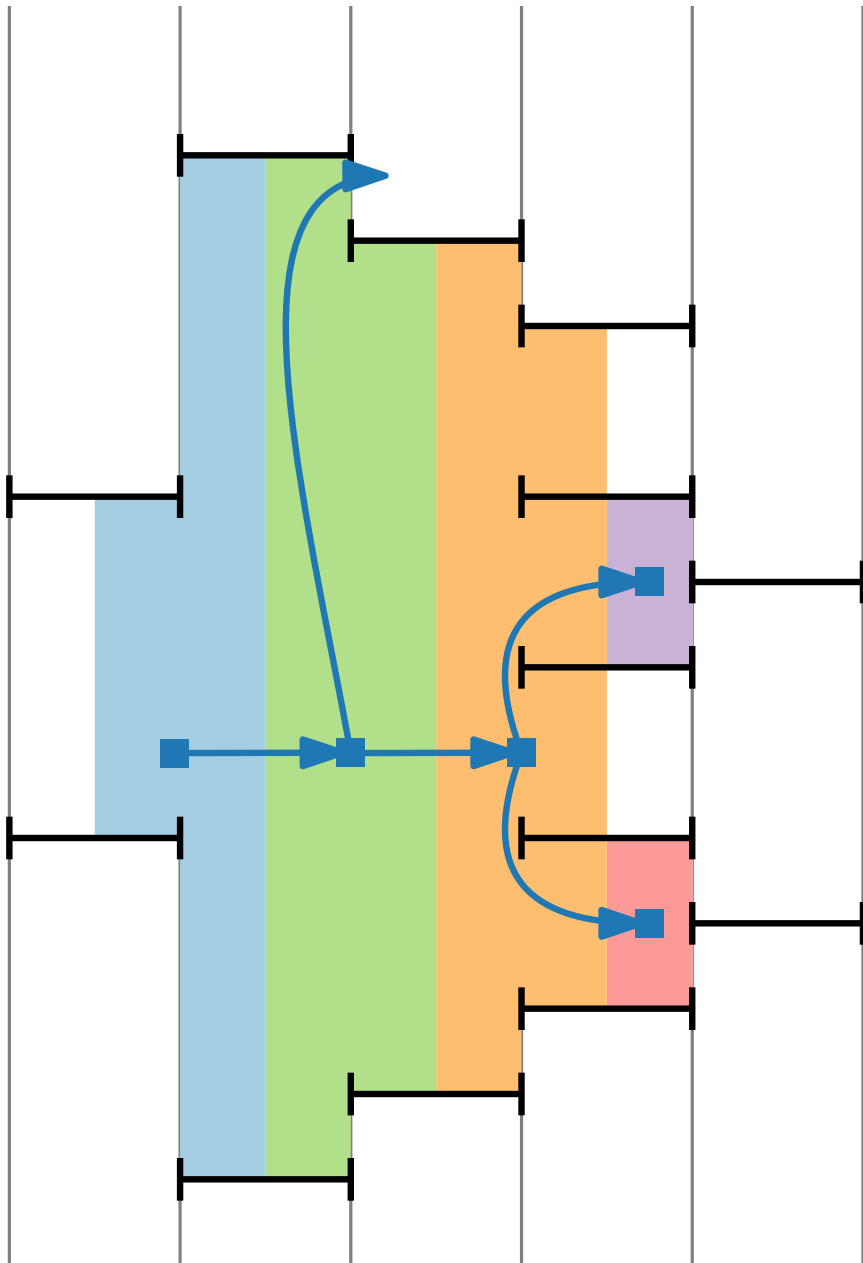

Weak: Biconnected Outerplanar, maxdeg 4

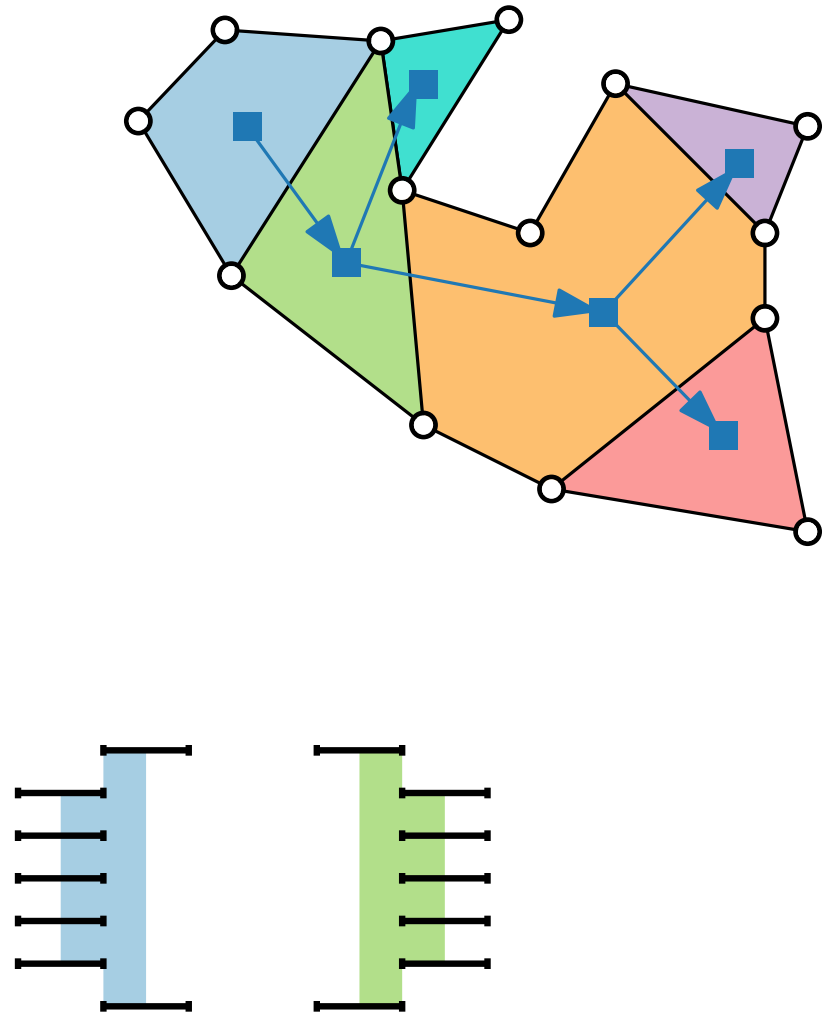
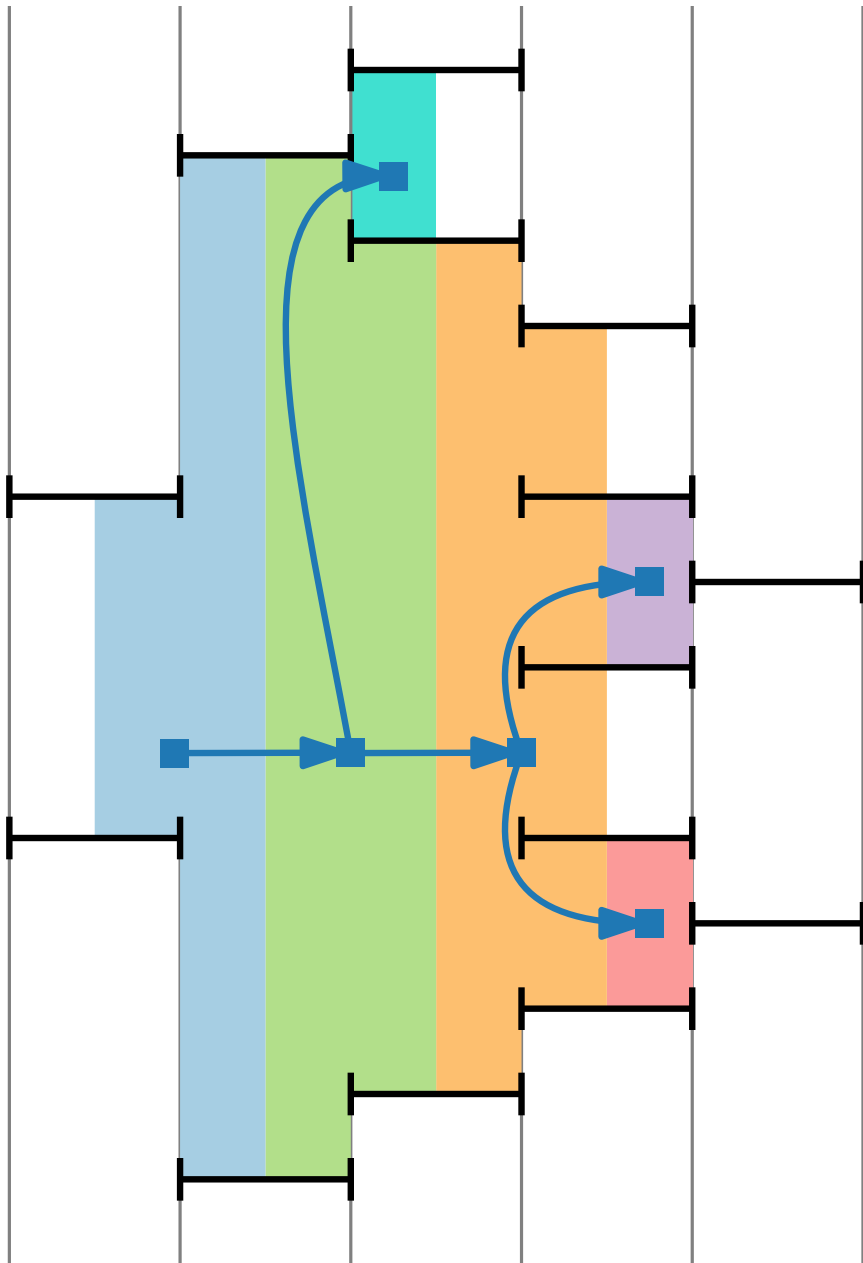

Weak: Biconnected Outerplanar, maxdeg 4

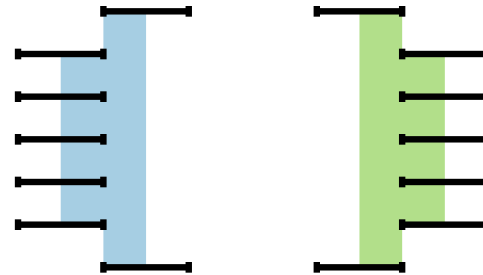
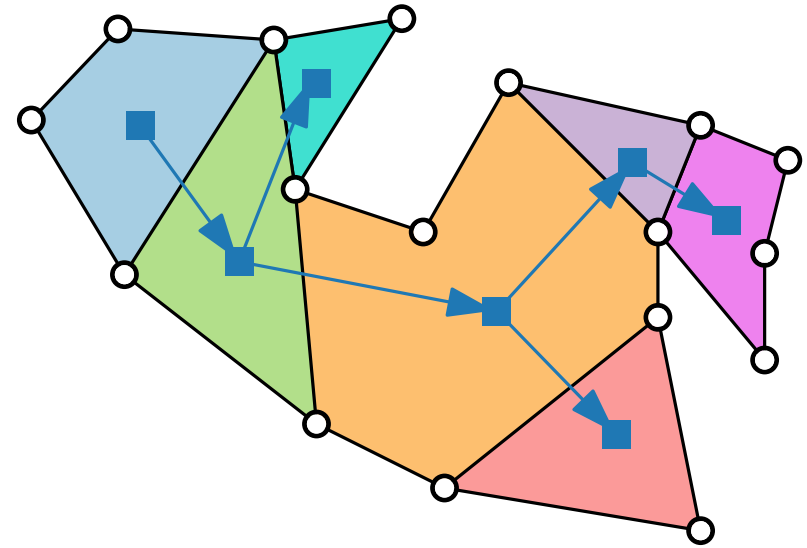
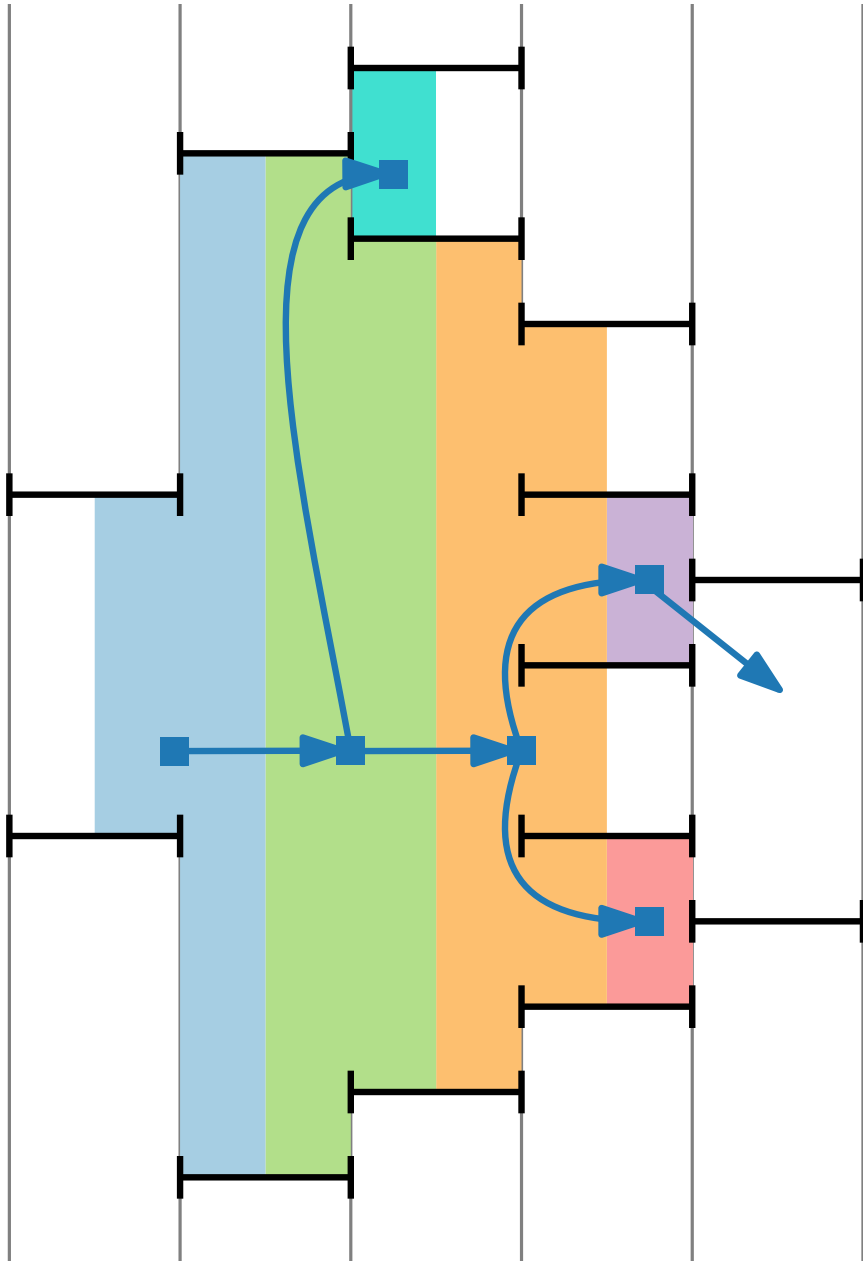

Weak: Biconnected Outerplanar, maxdeg 4

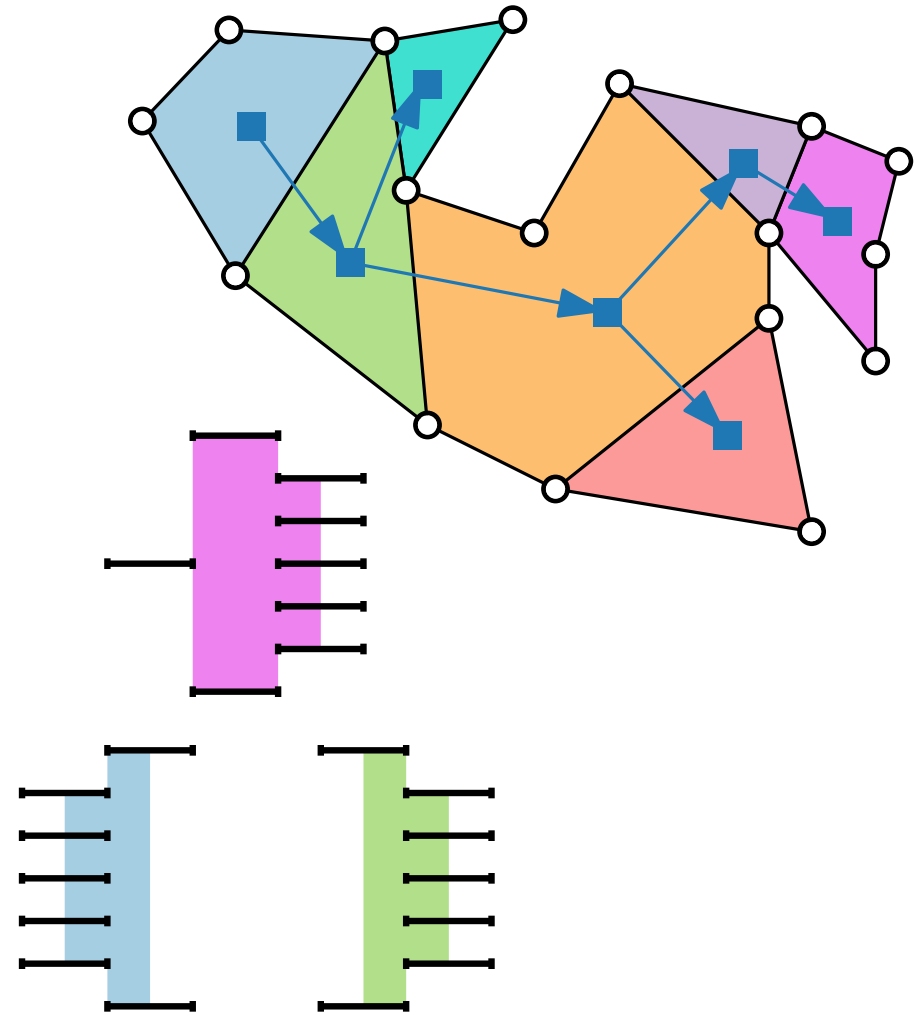
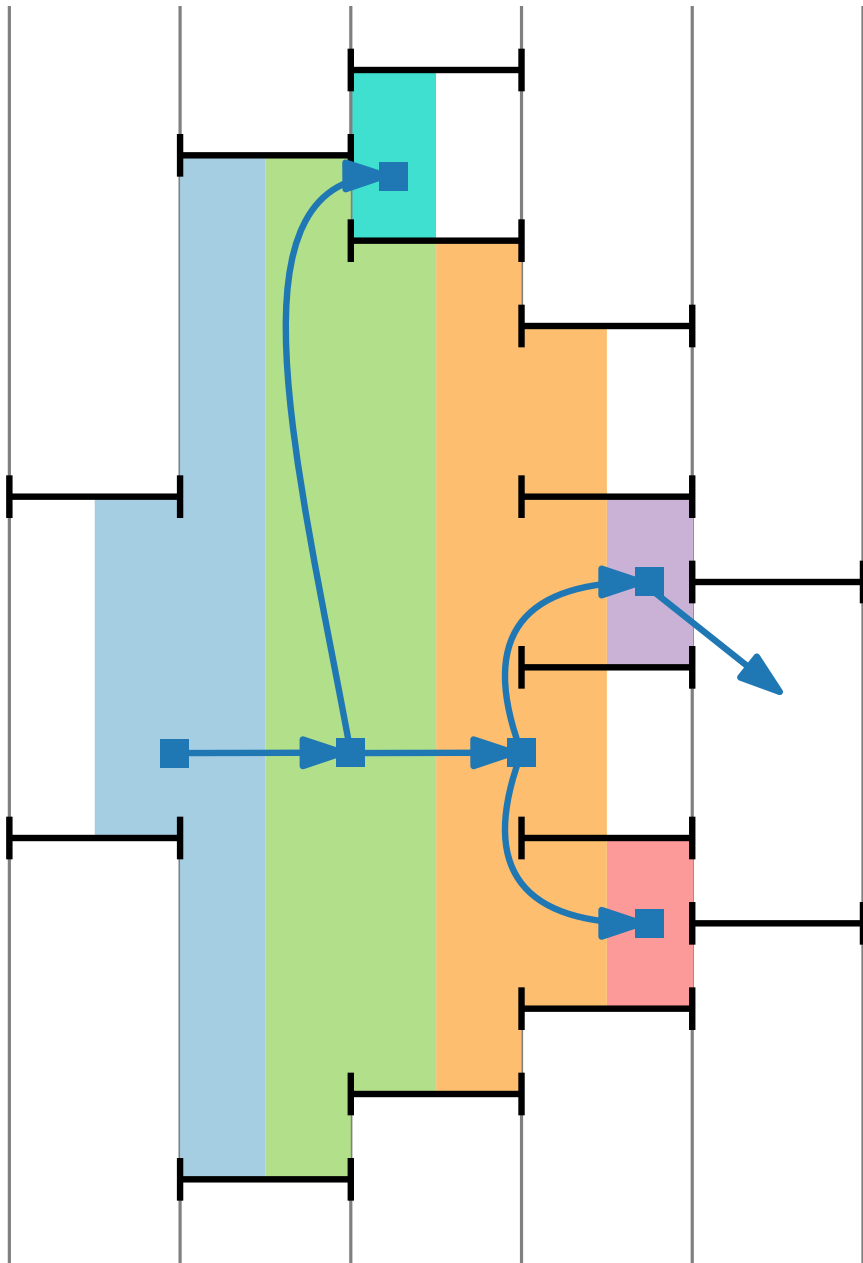

Weak: Biconnected Outerplanar, maxdeg 4

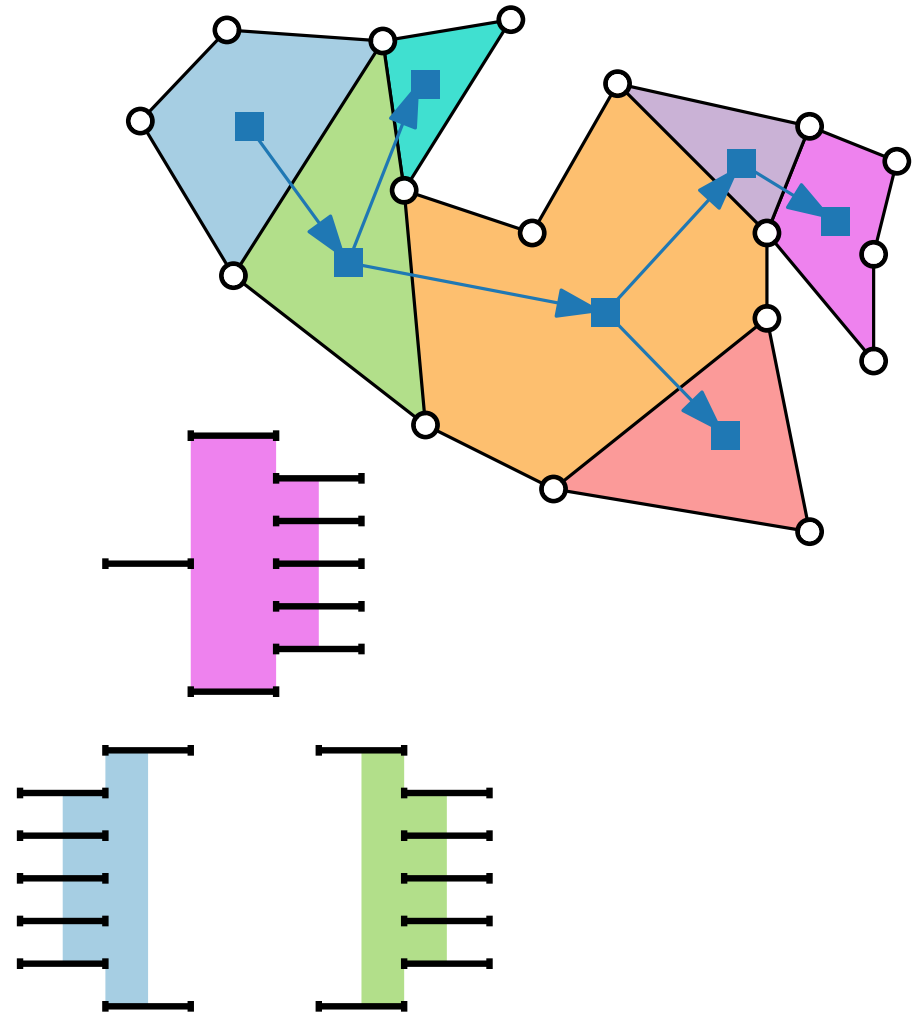
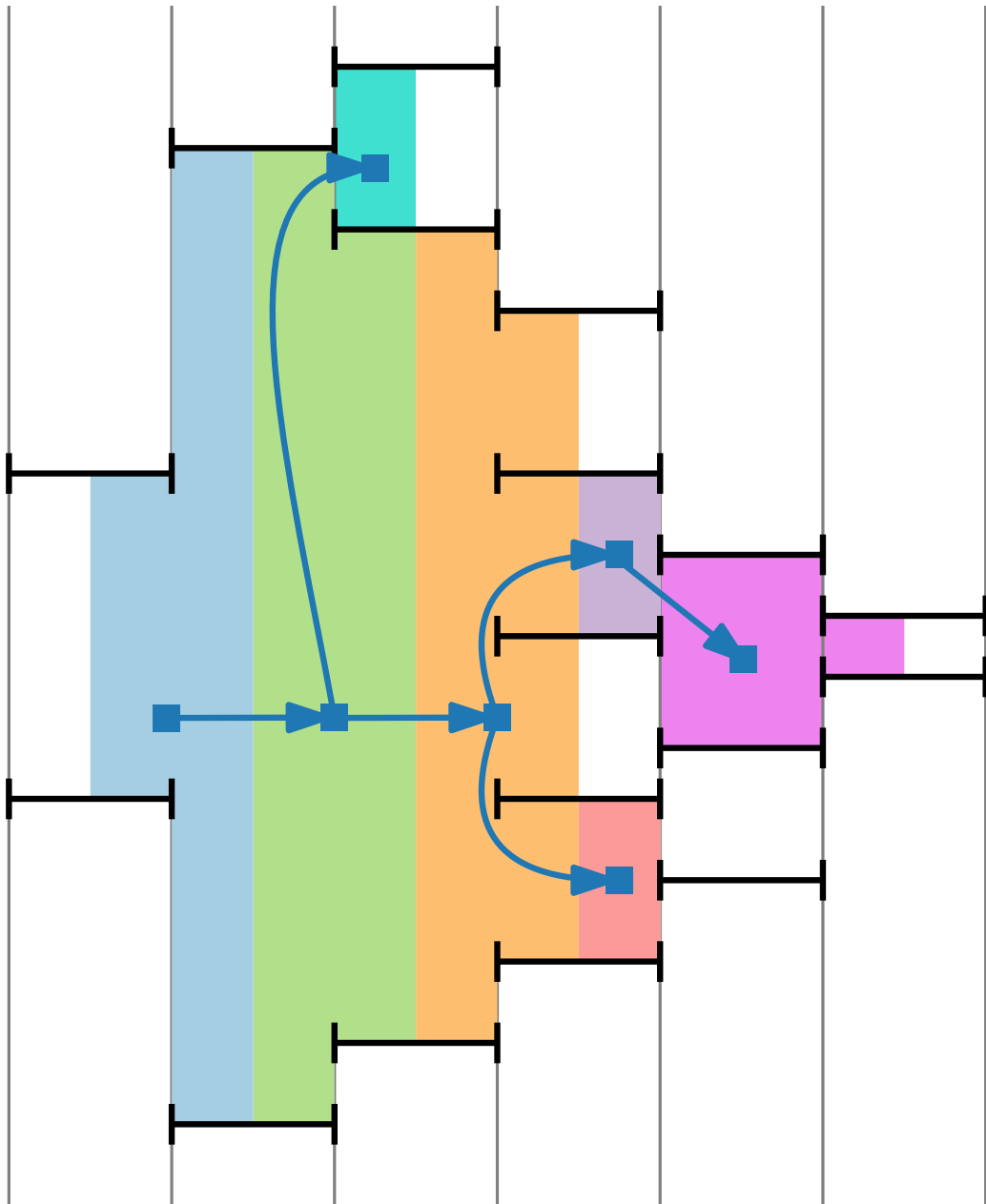

Weak: Biconnected Outerplanar, maxdeg 4

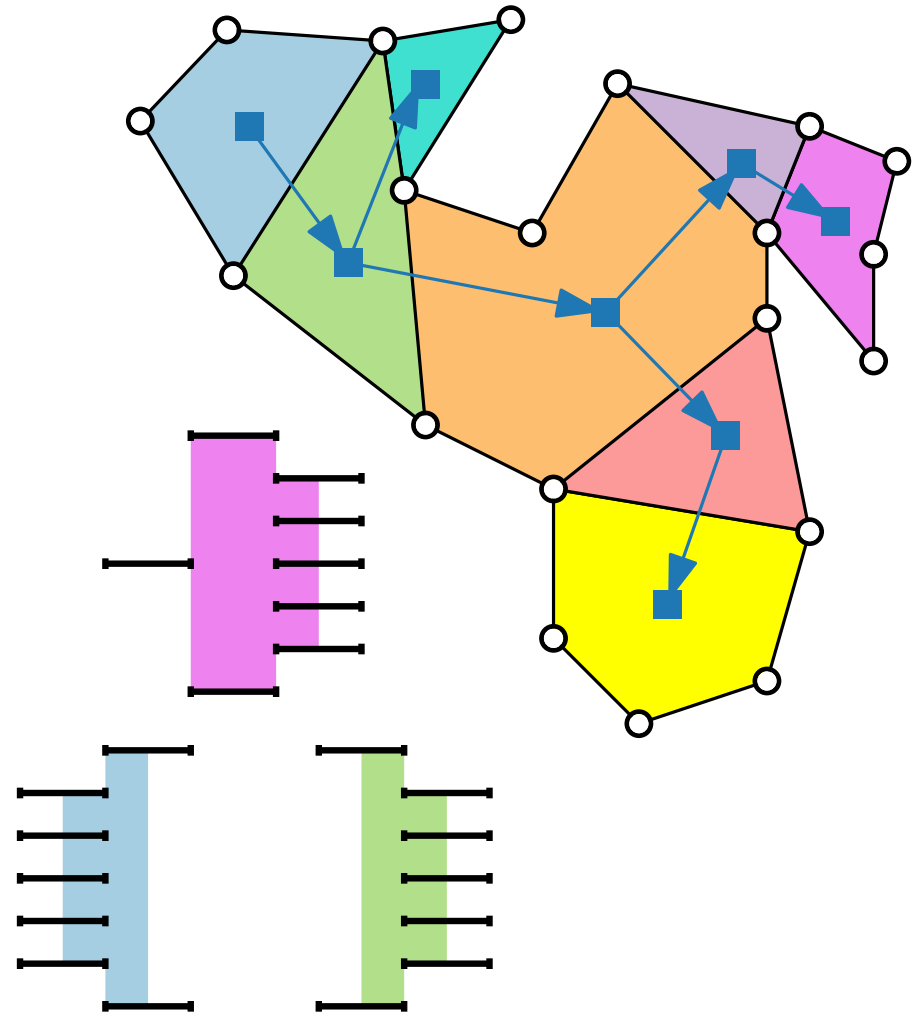
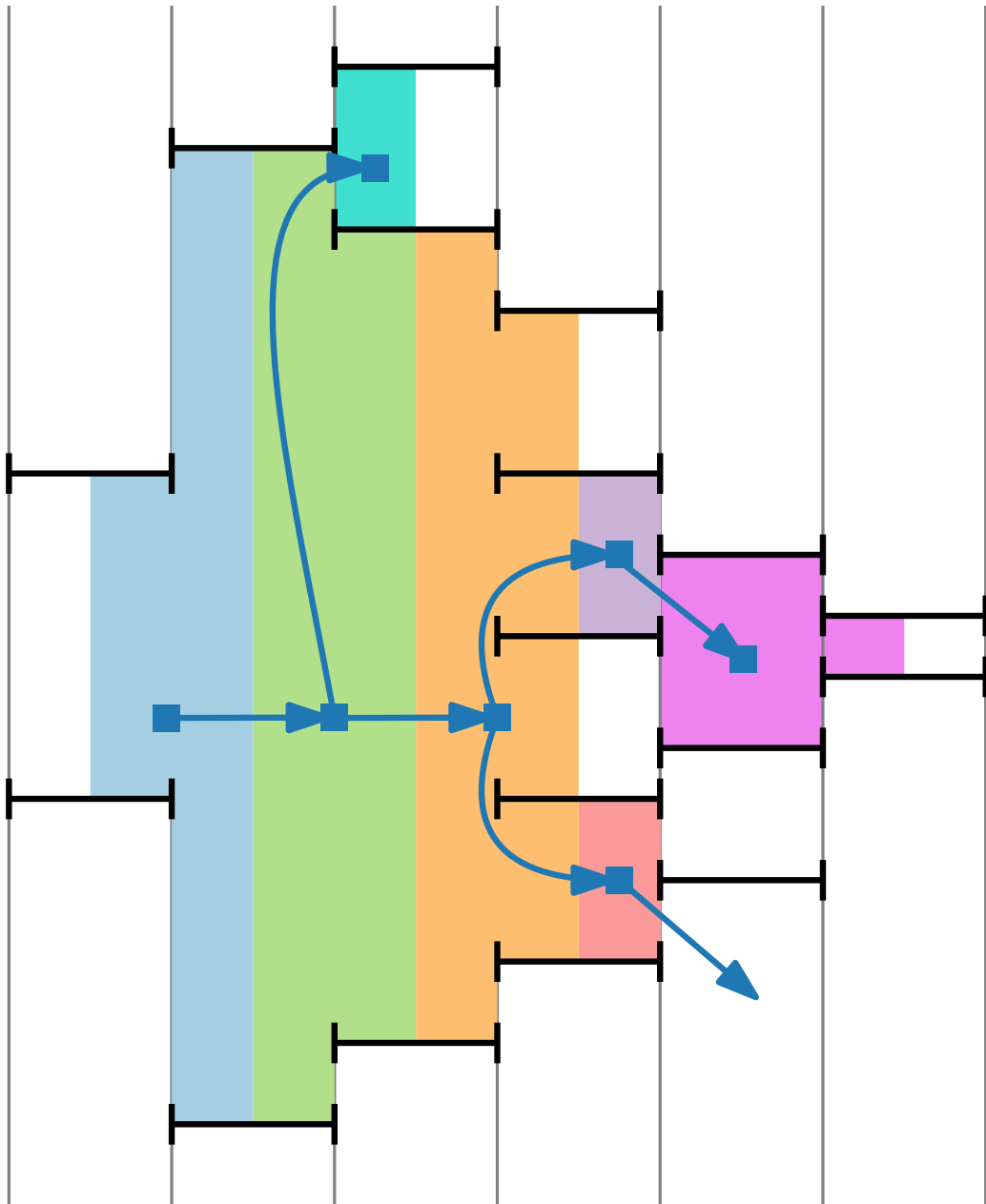

Weak: Biconnected Outerplanar, maxdeg 4

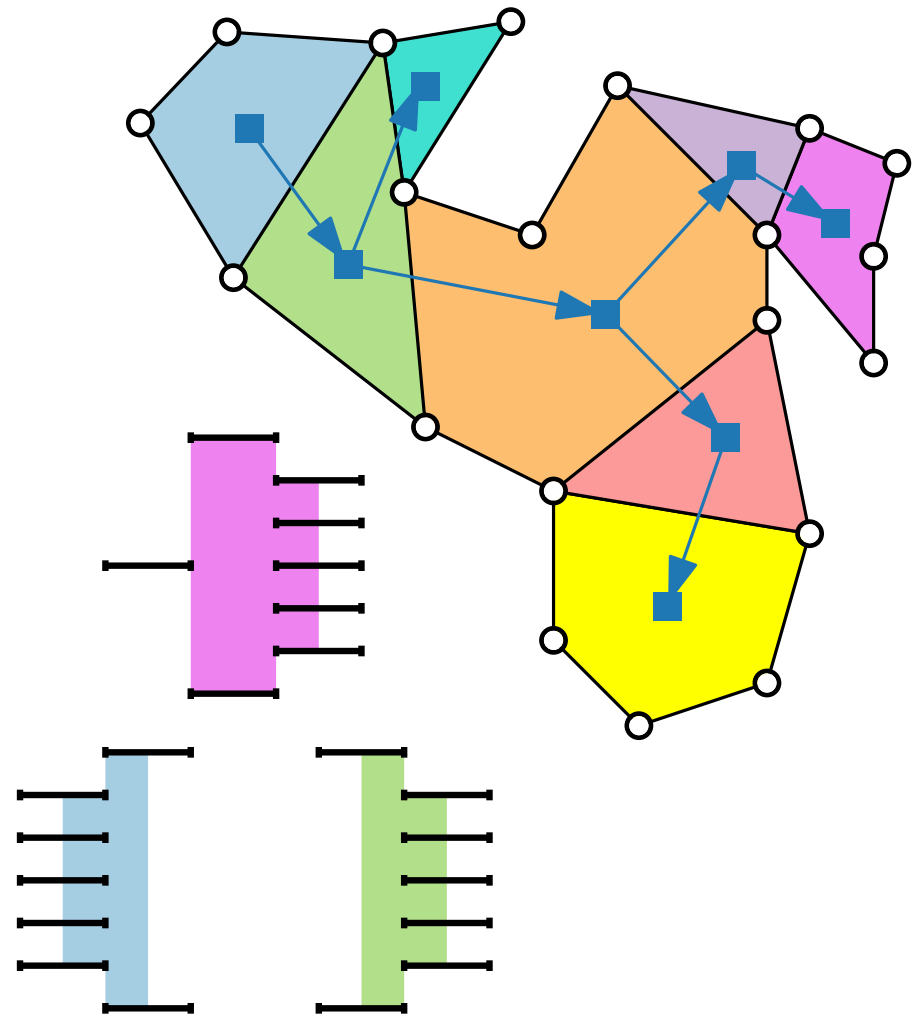
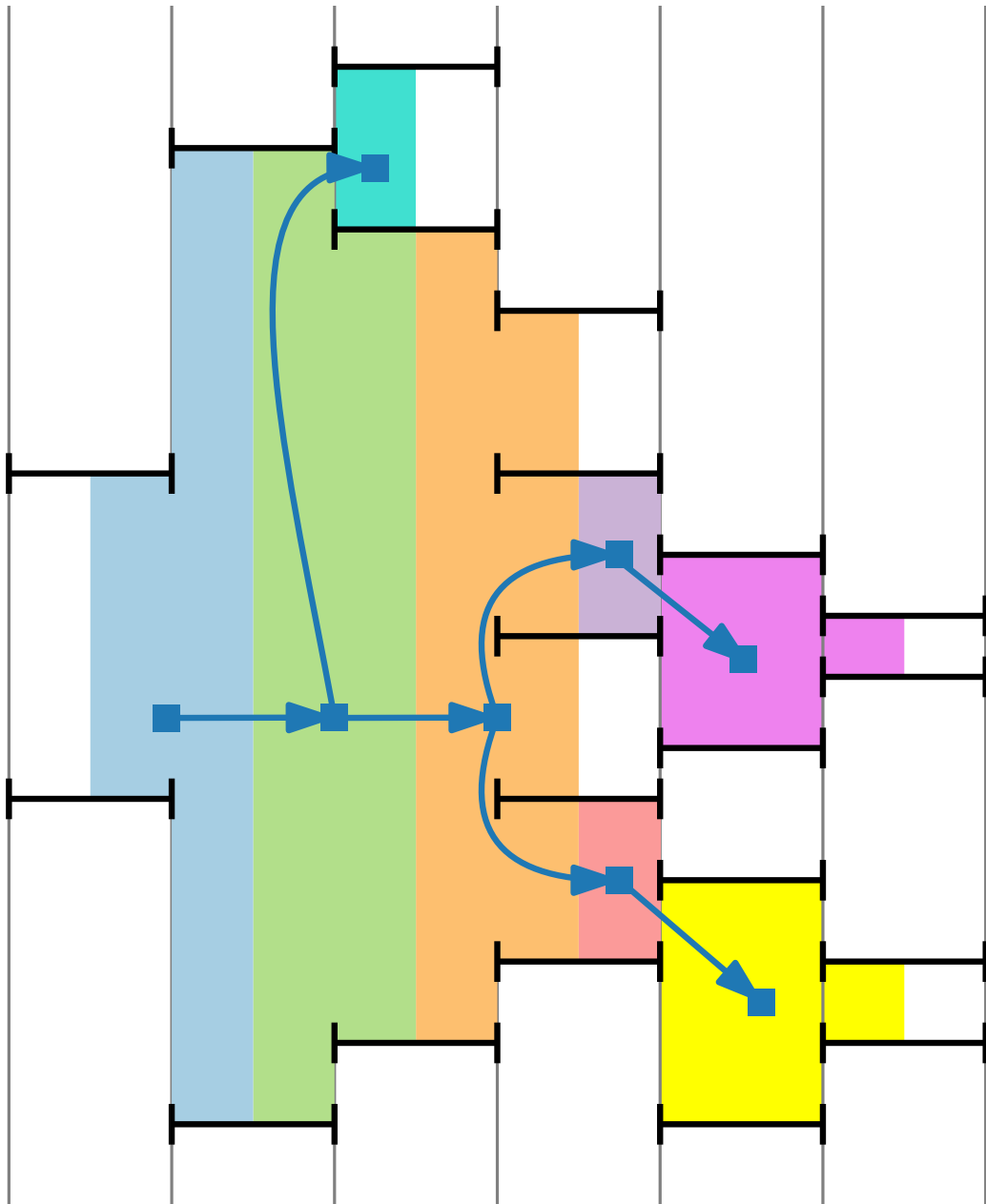

Weak: Biconnected Outerplanar, maxdeg 4

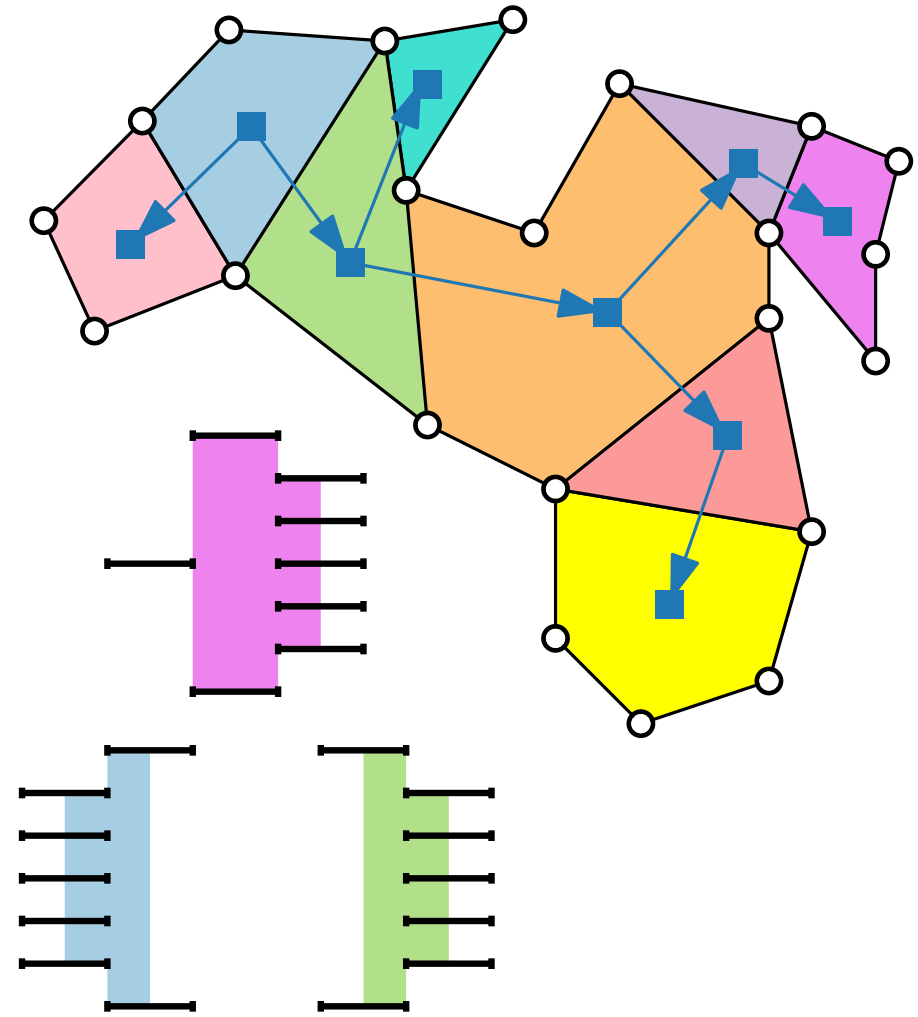
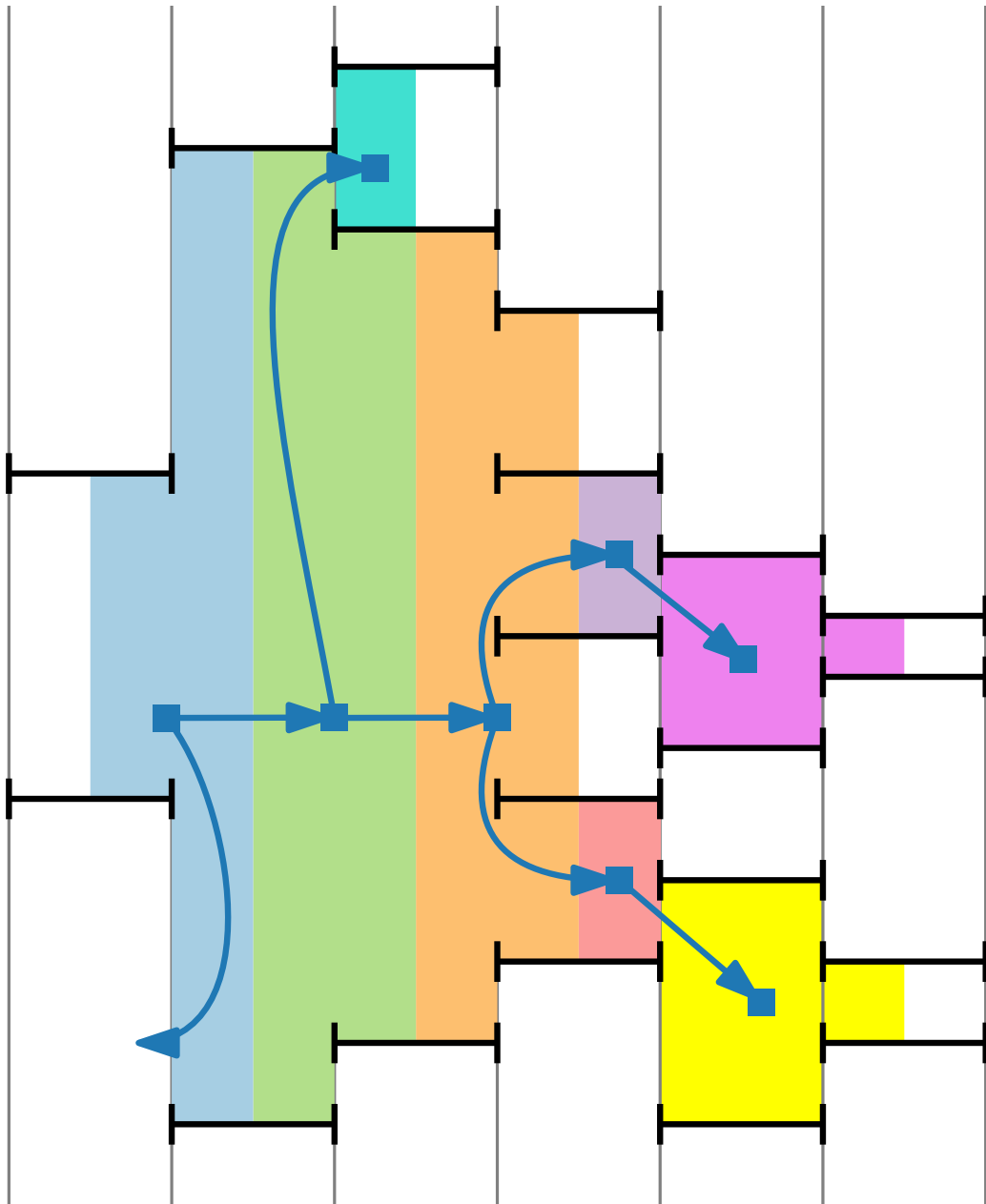

Weak: Biconnected Outerplanar, maxdeg 4

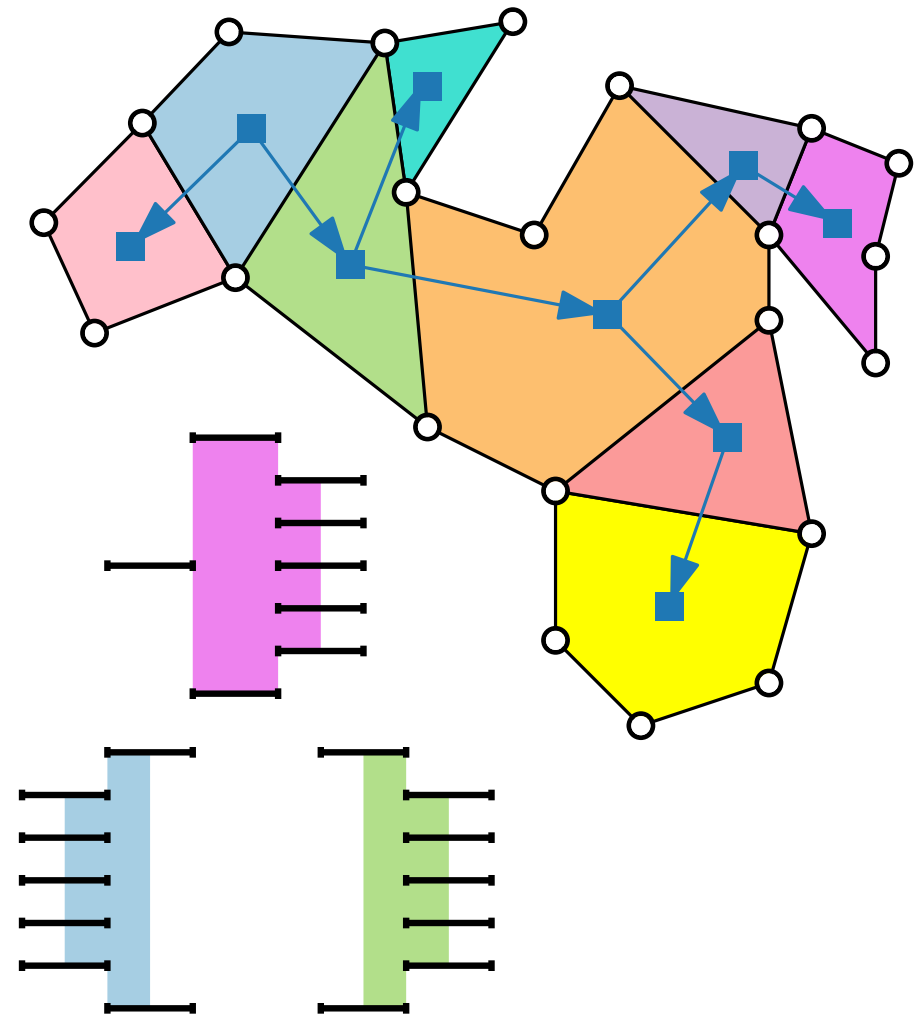
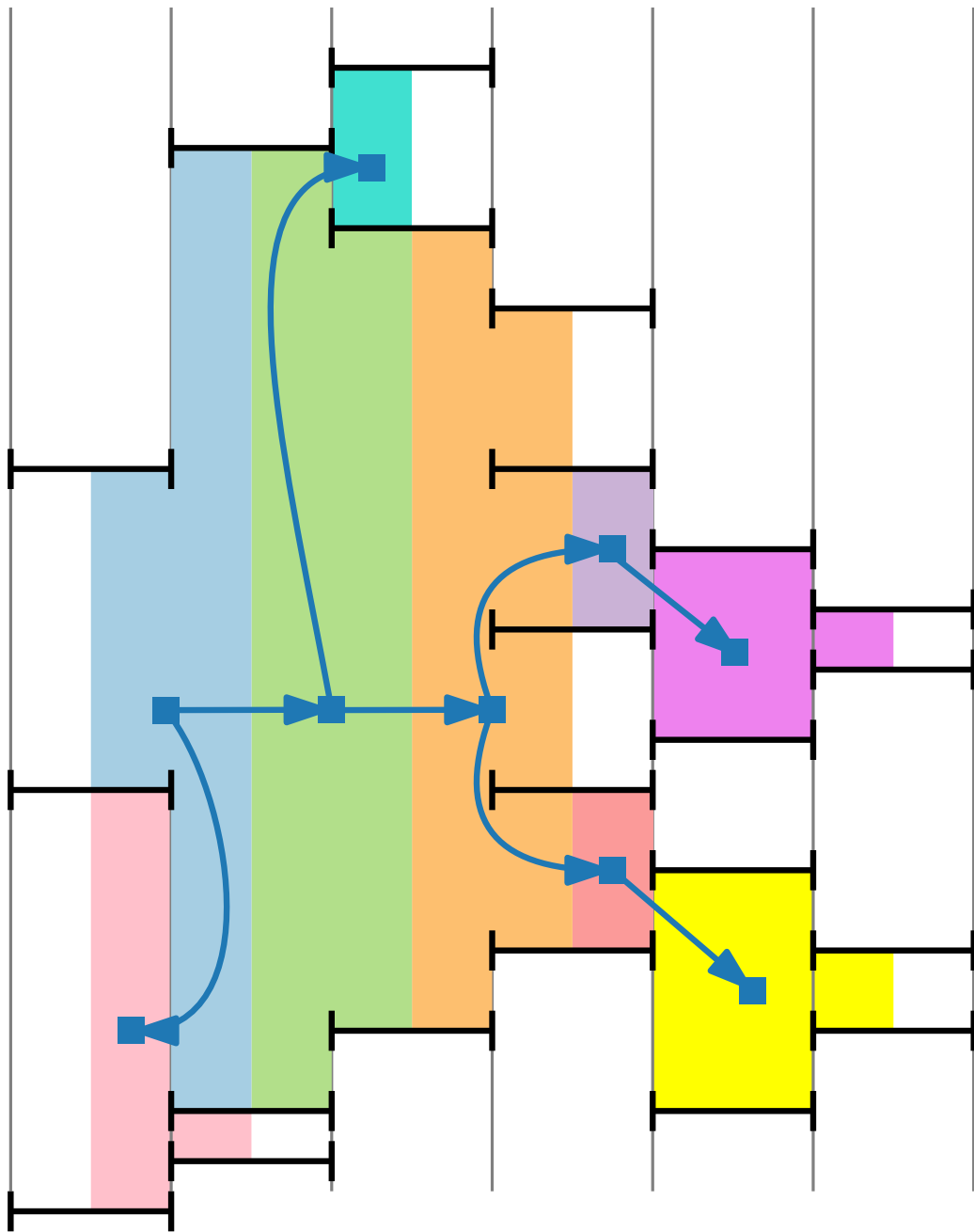

Weak: Biconnected Outerplanar, maxdeg 4

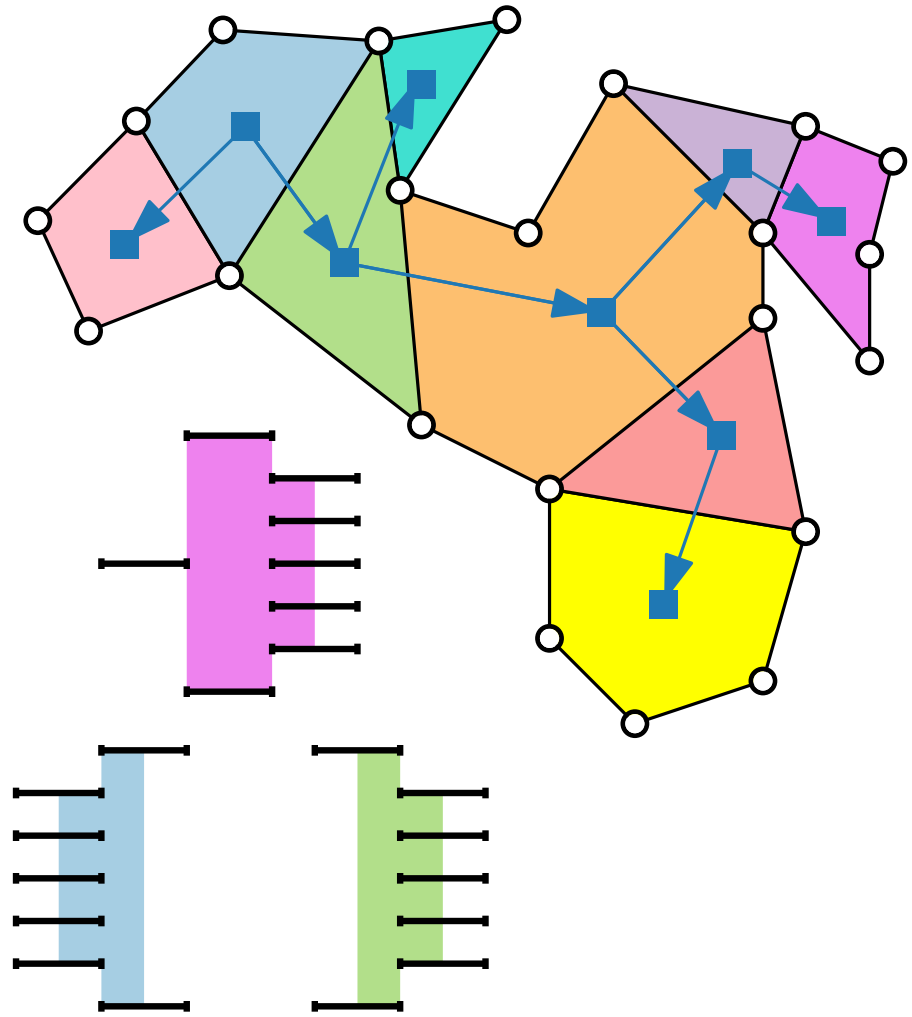
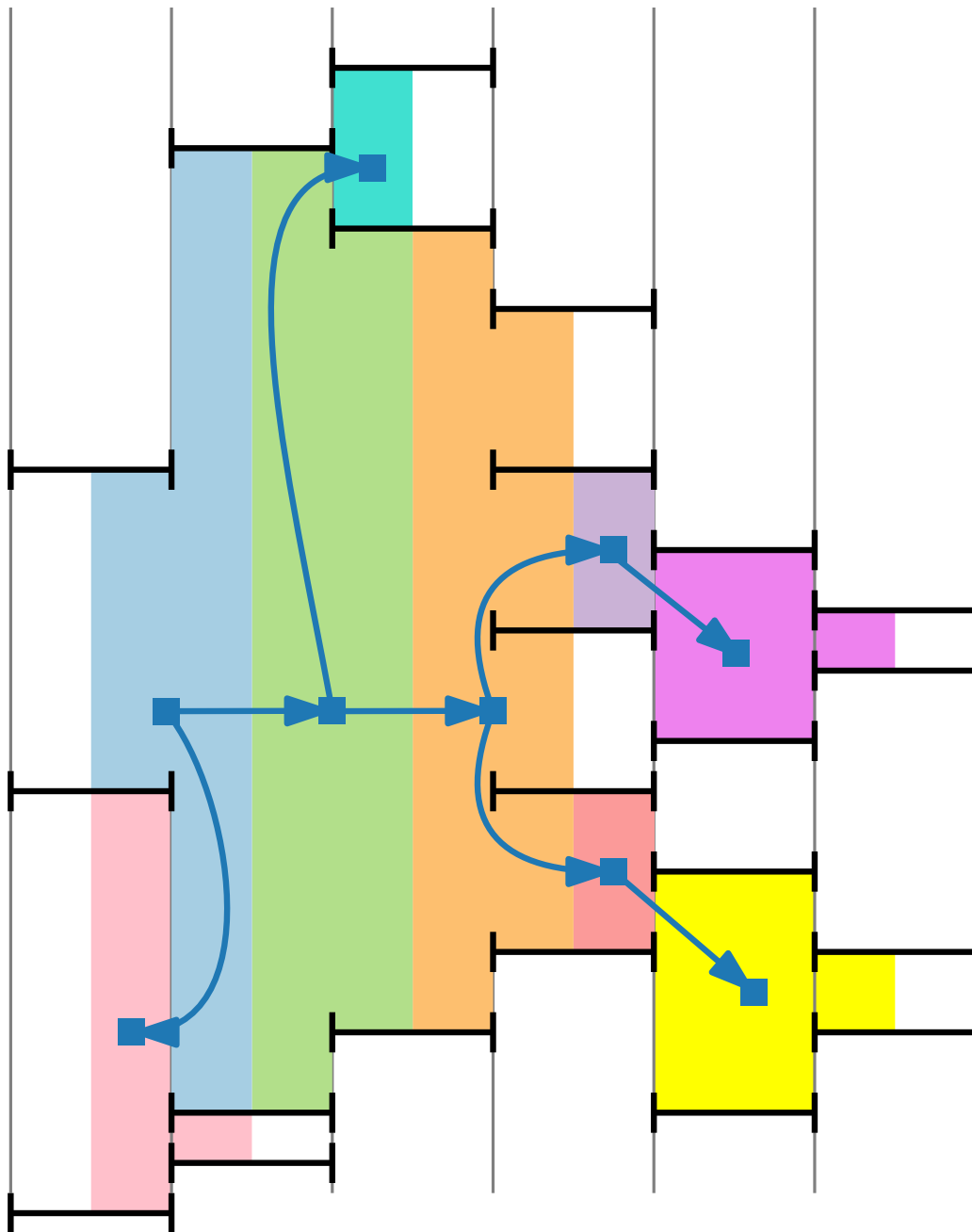

Biconnected Outerplanar
with maxdeg 4 ✓

Weak: Biconnected Outerplanar, maxdeg 4

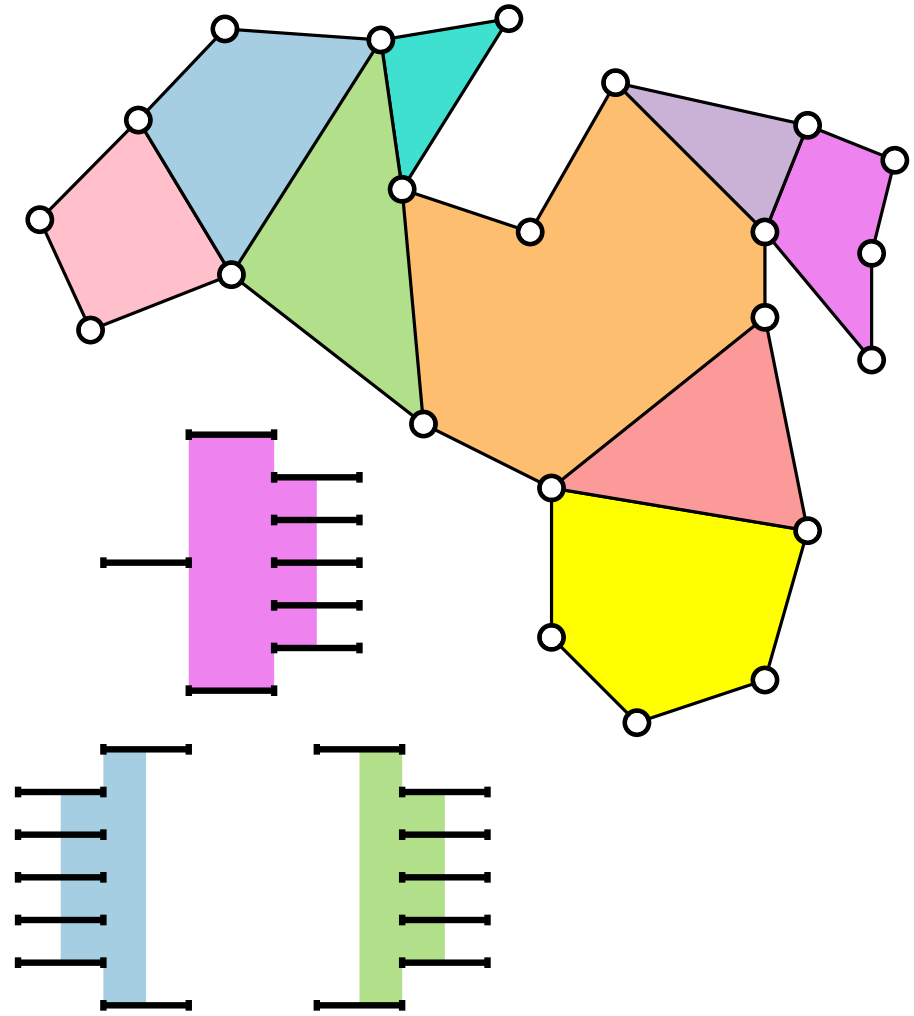
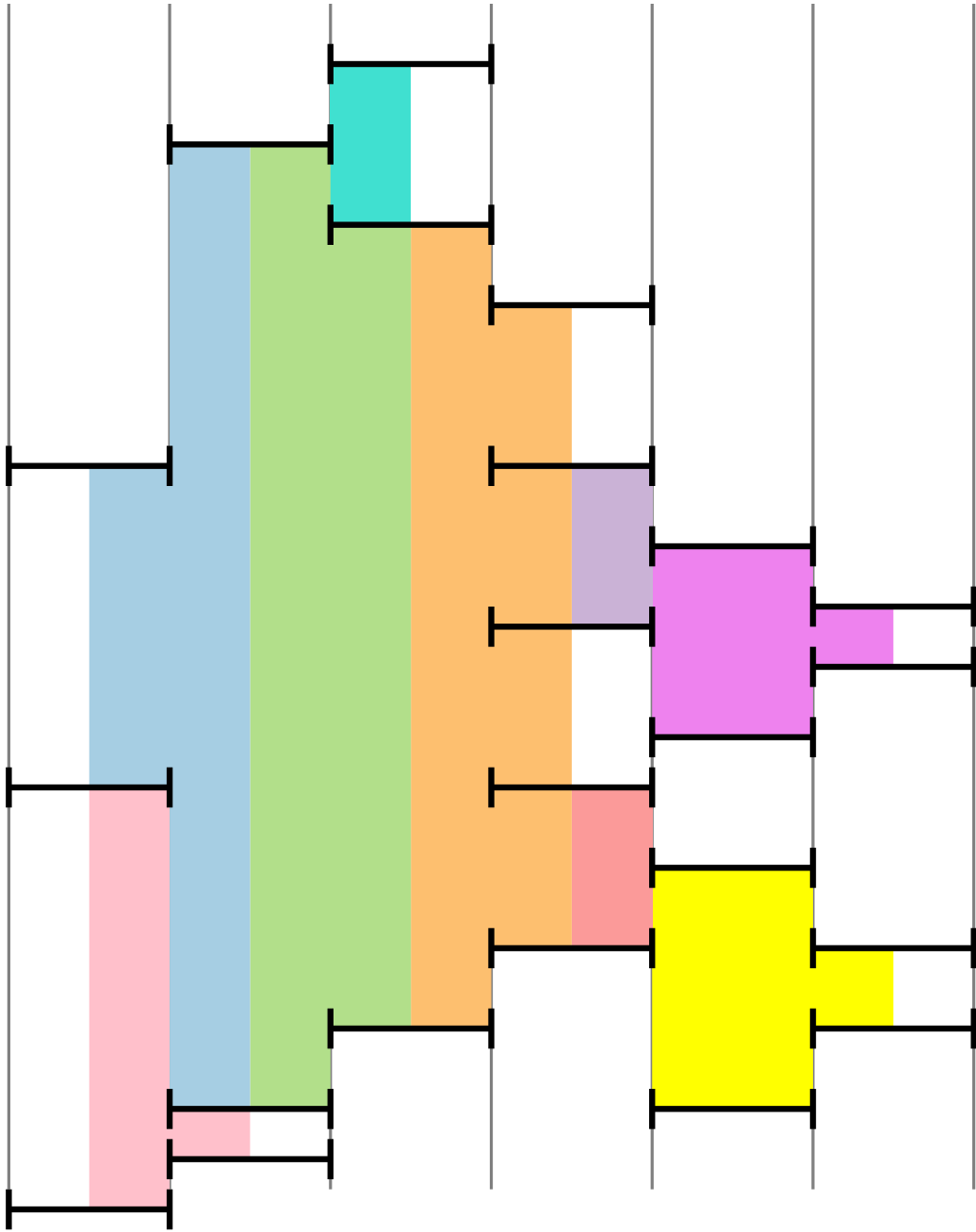

Weak: Biconnected Outerplanar, maxdeg 4

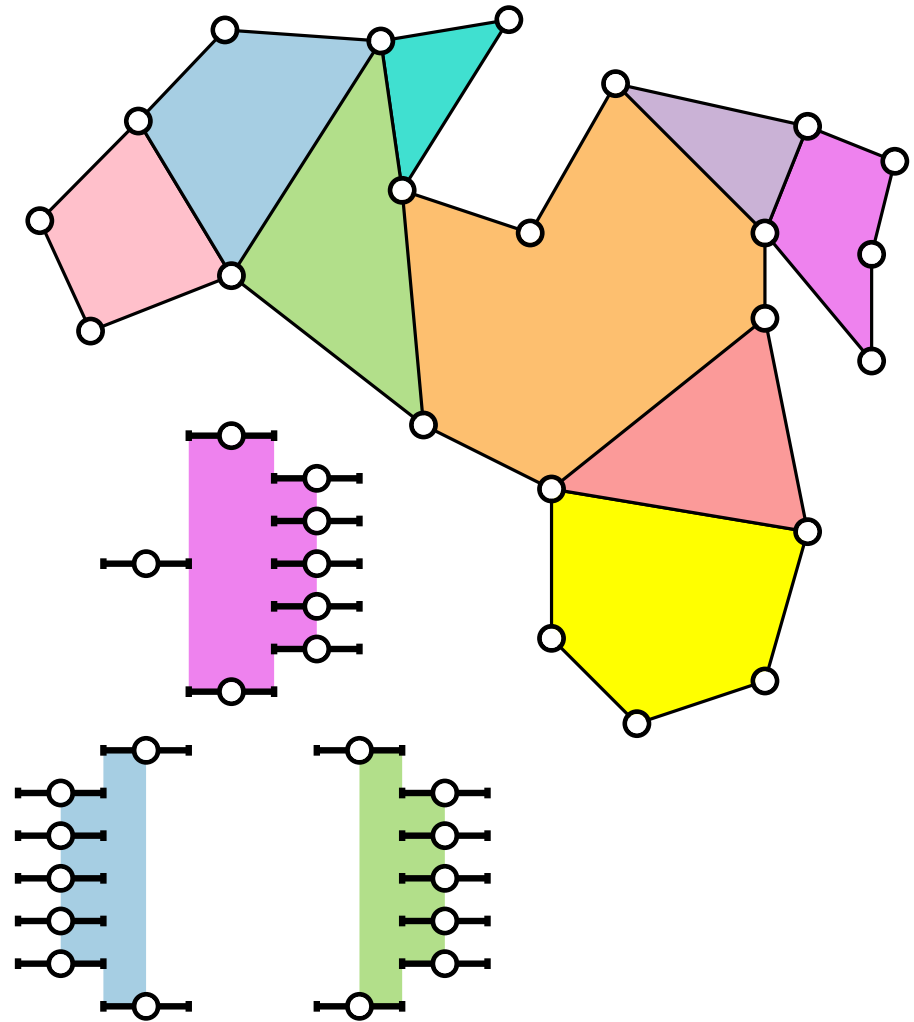
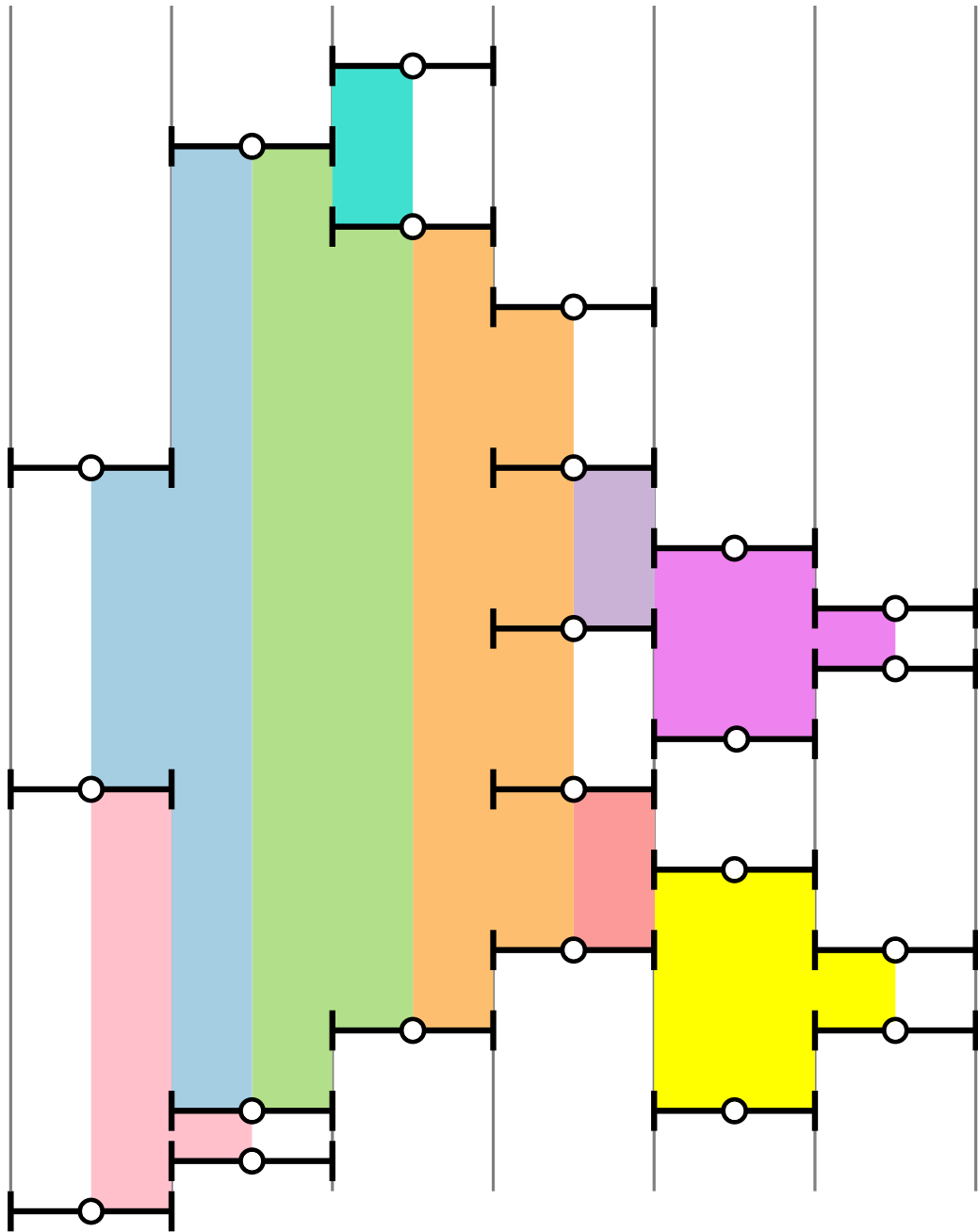

Weak: Biconnected Outerplanar, maxdeg 4

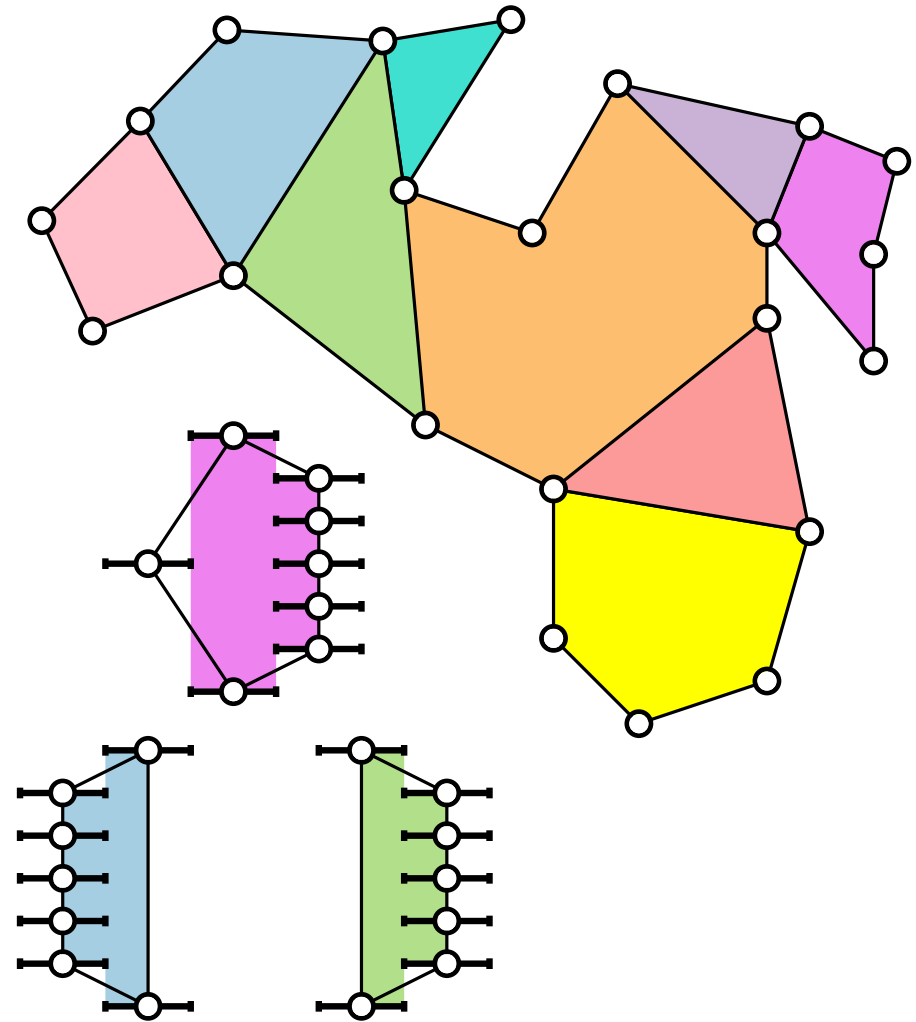
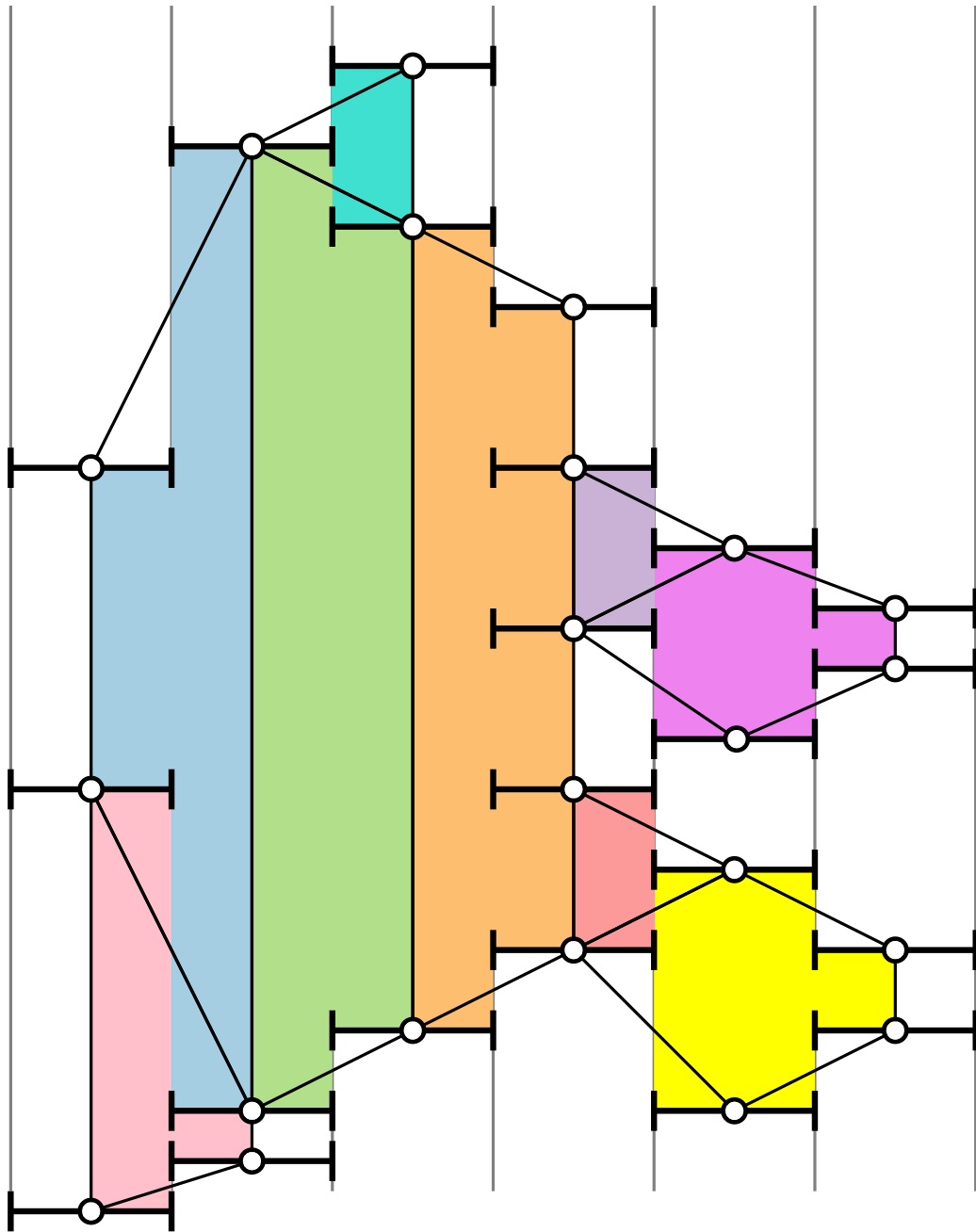

Weak: Biconnected Outerplanar, maxdeg 4

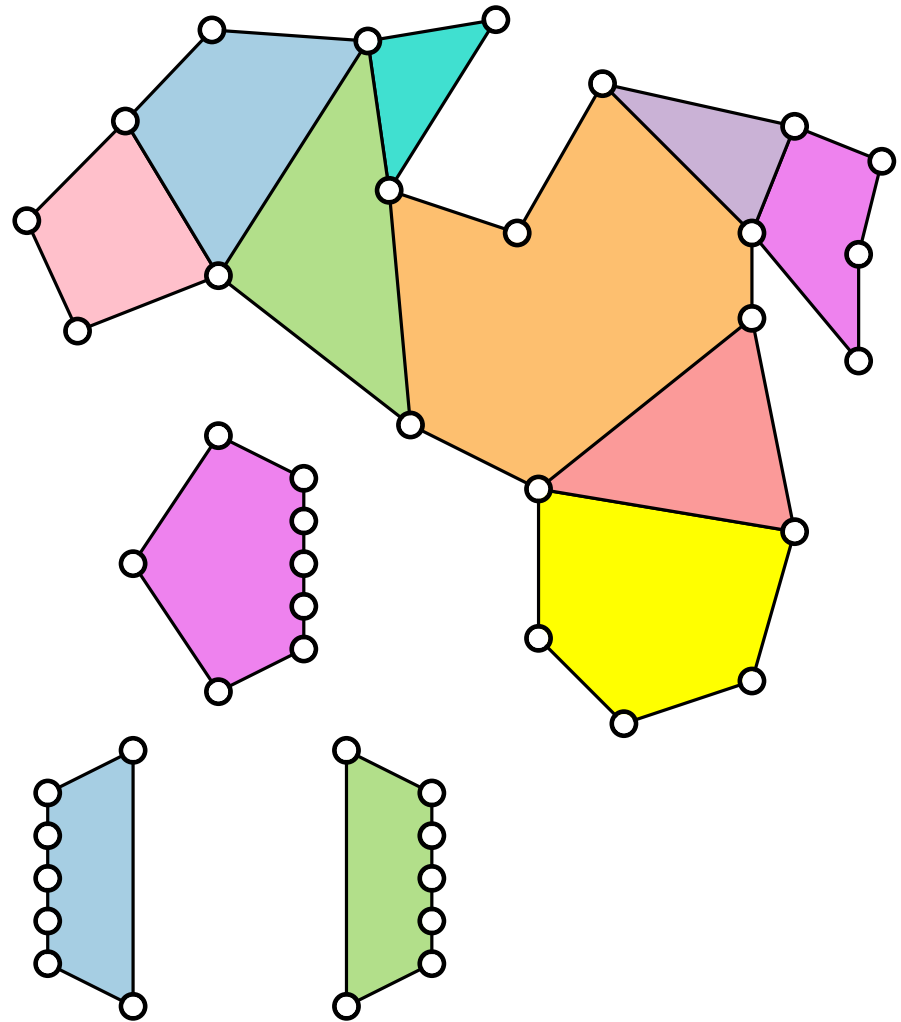
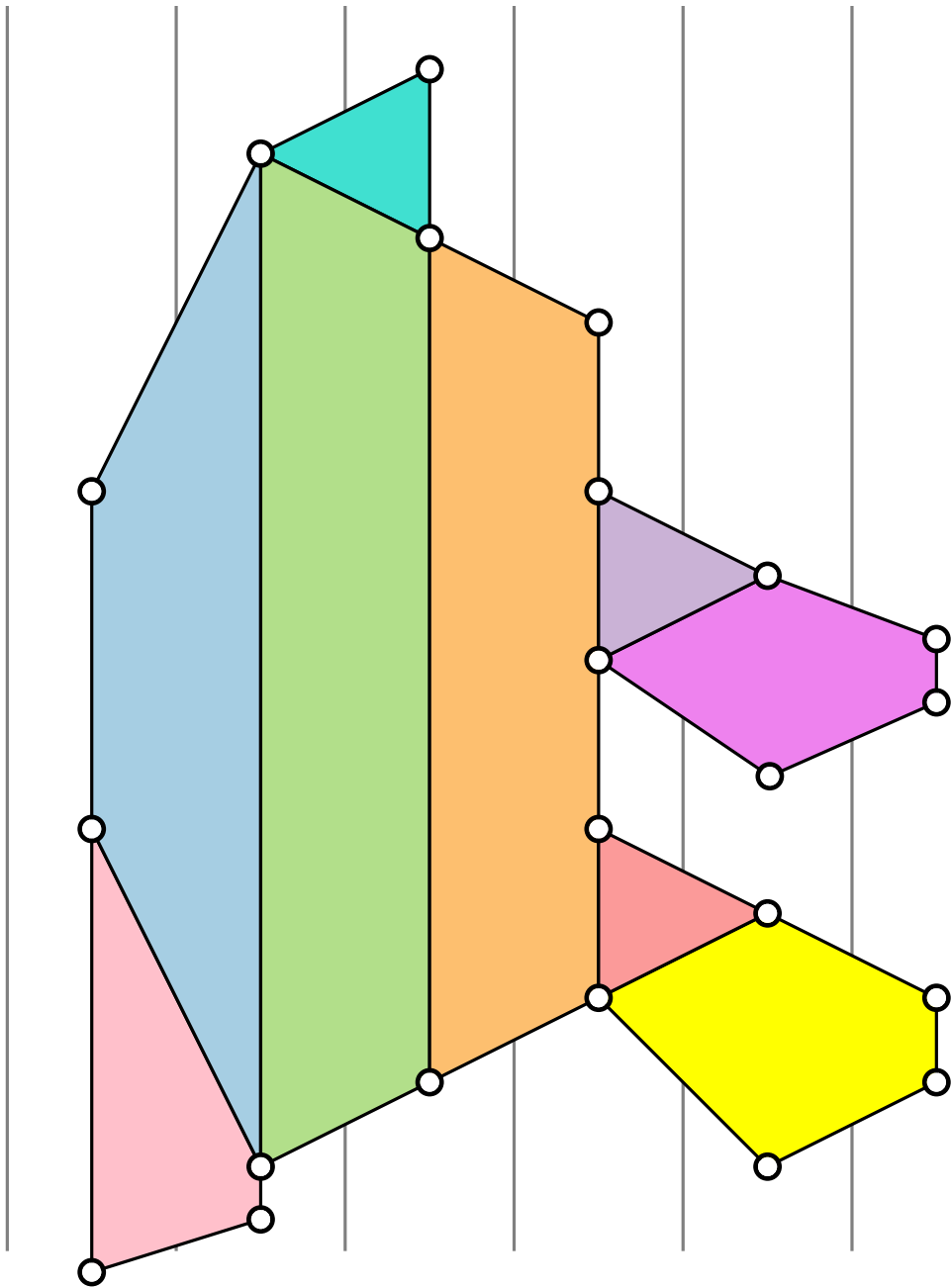

Weak: Biconnected Outerplanar, maxdeg 4

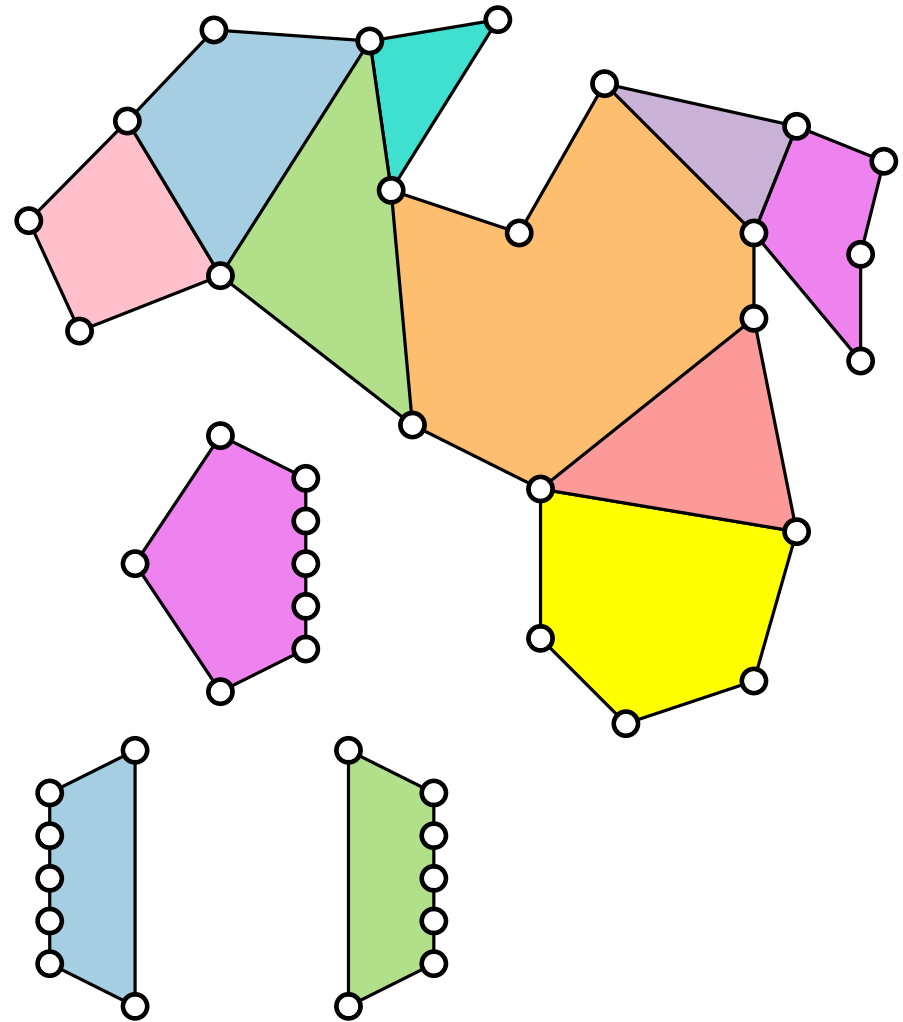
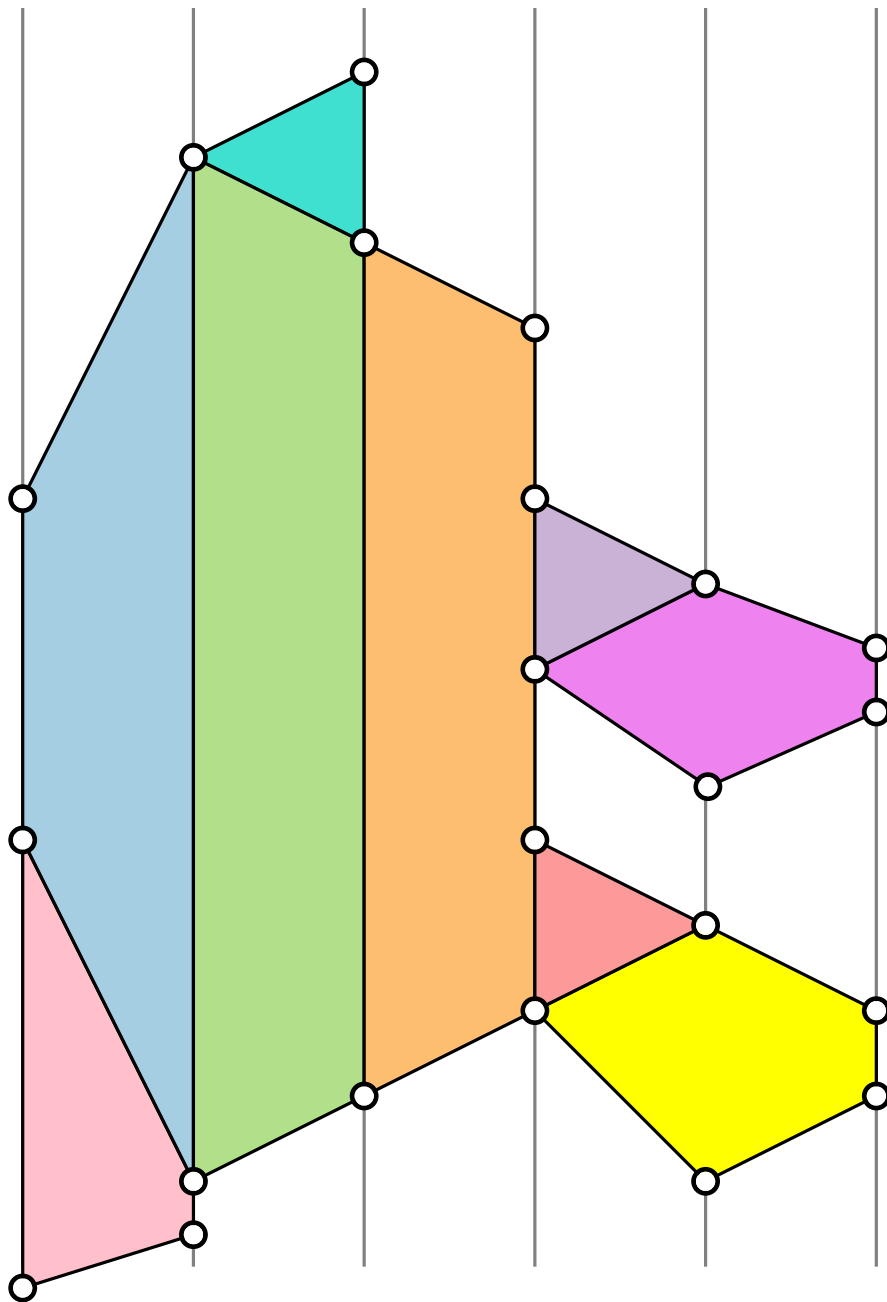

Layered Drawings

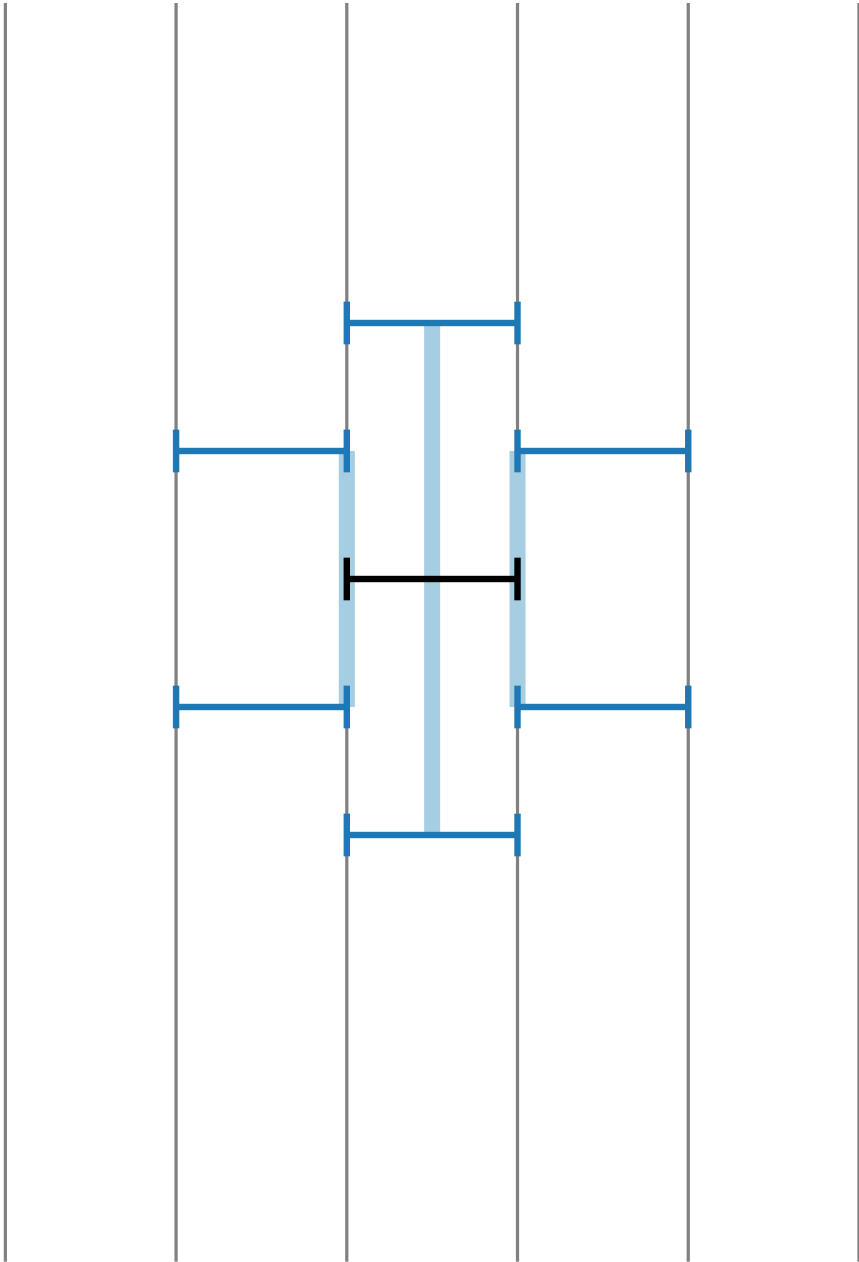

Layered Drawings

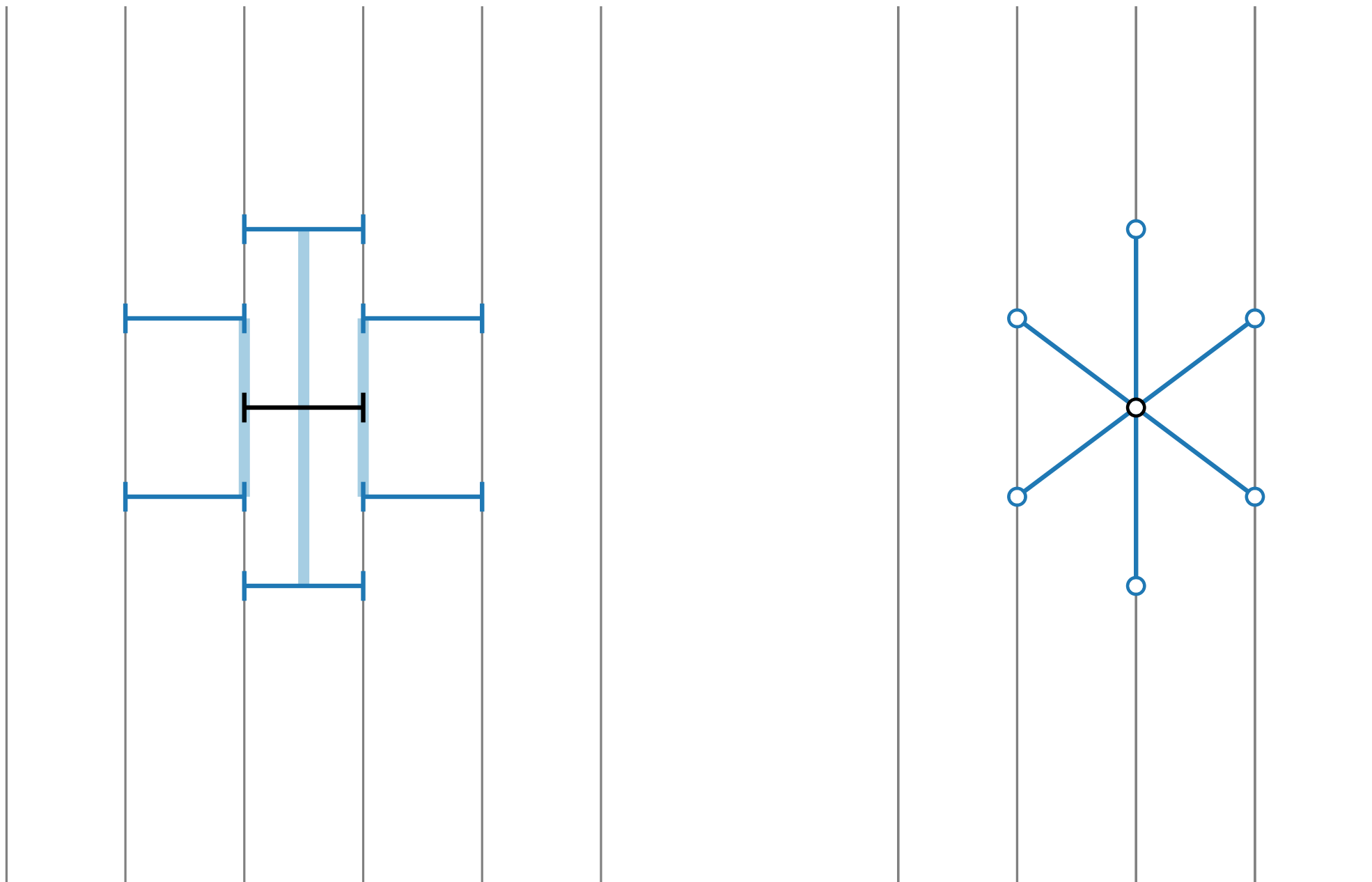

Layered Drawings

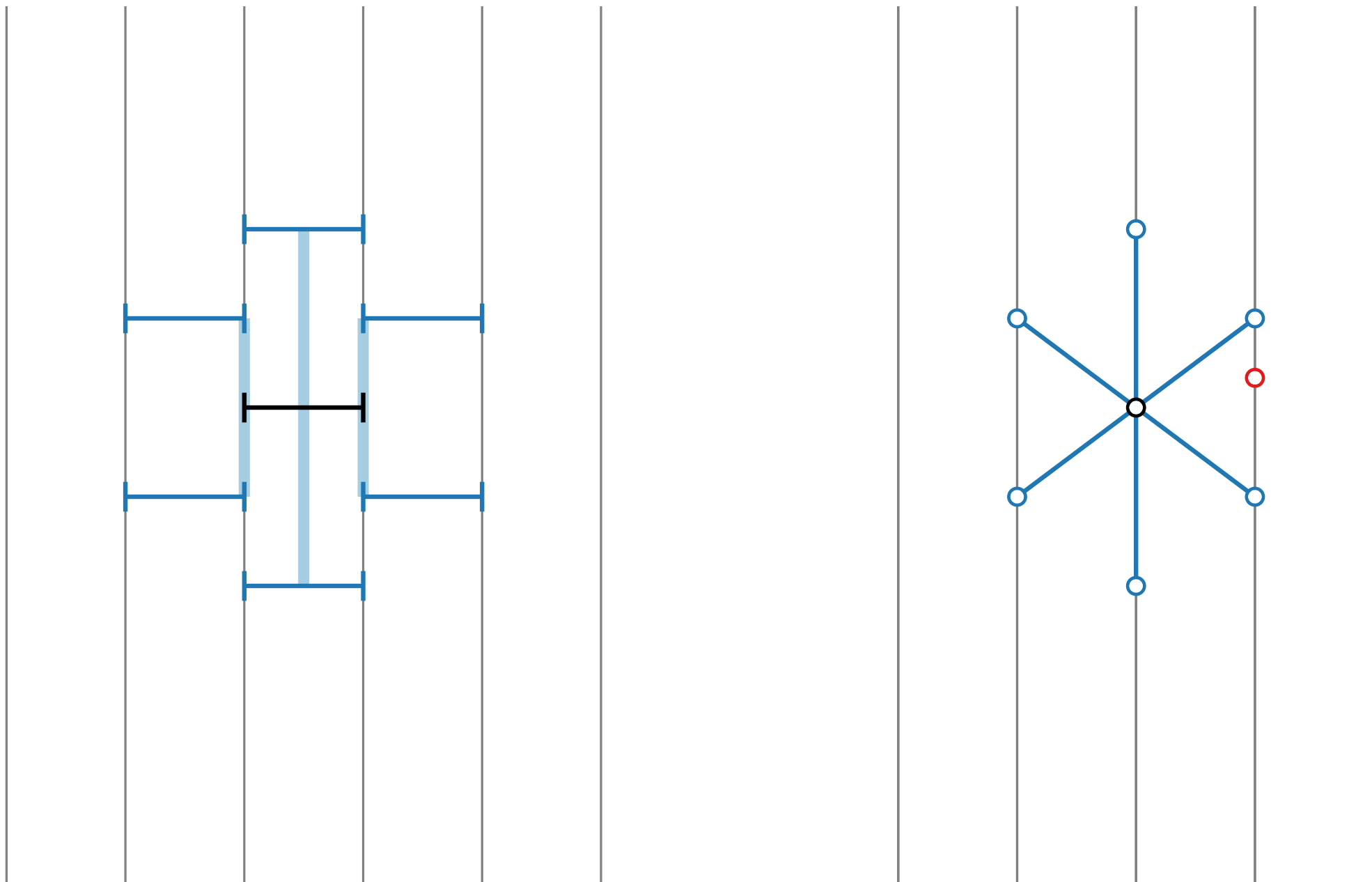

Layered Drawings

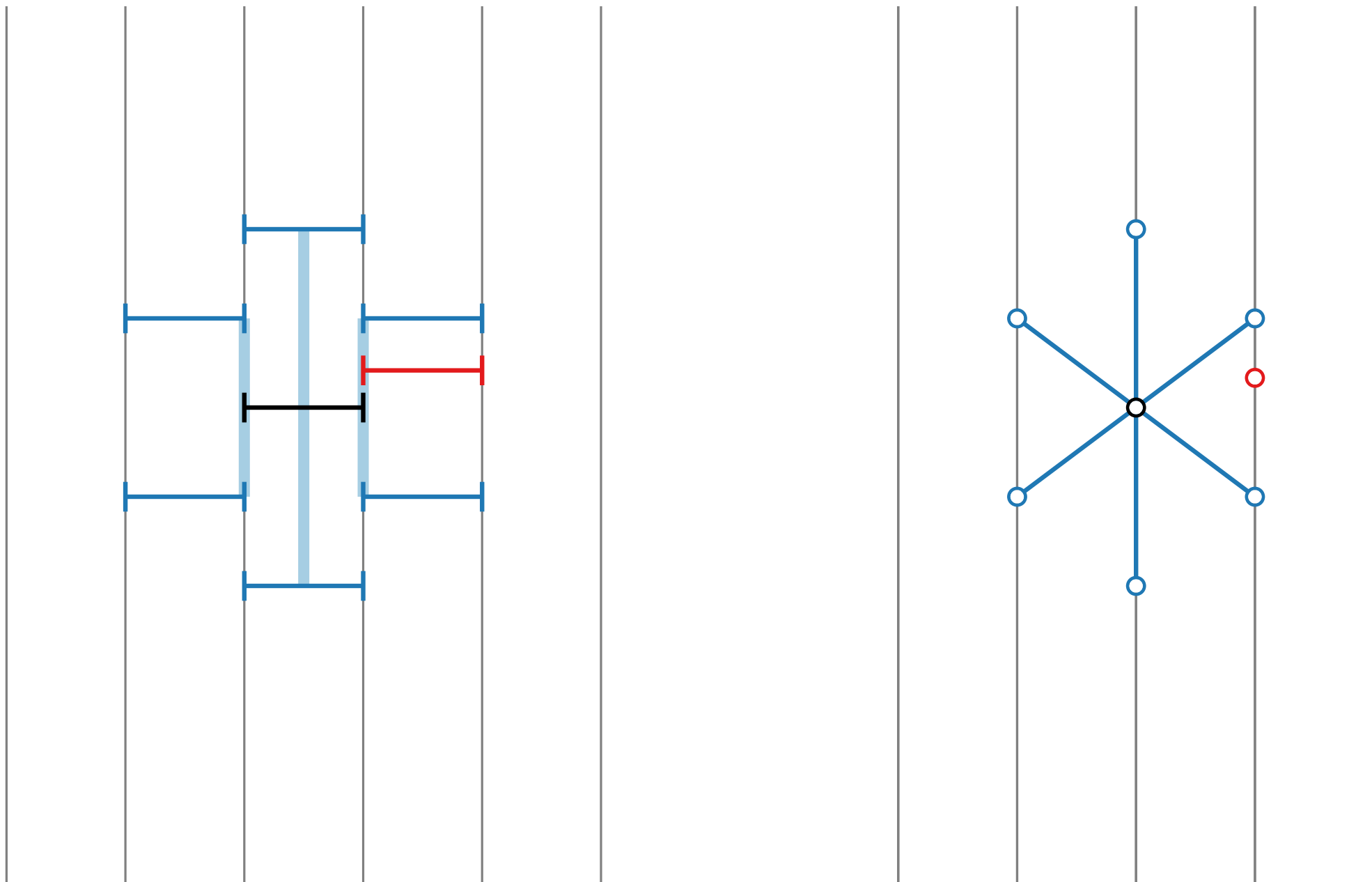

Layered Drawings

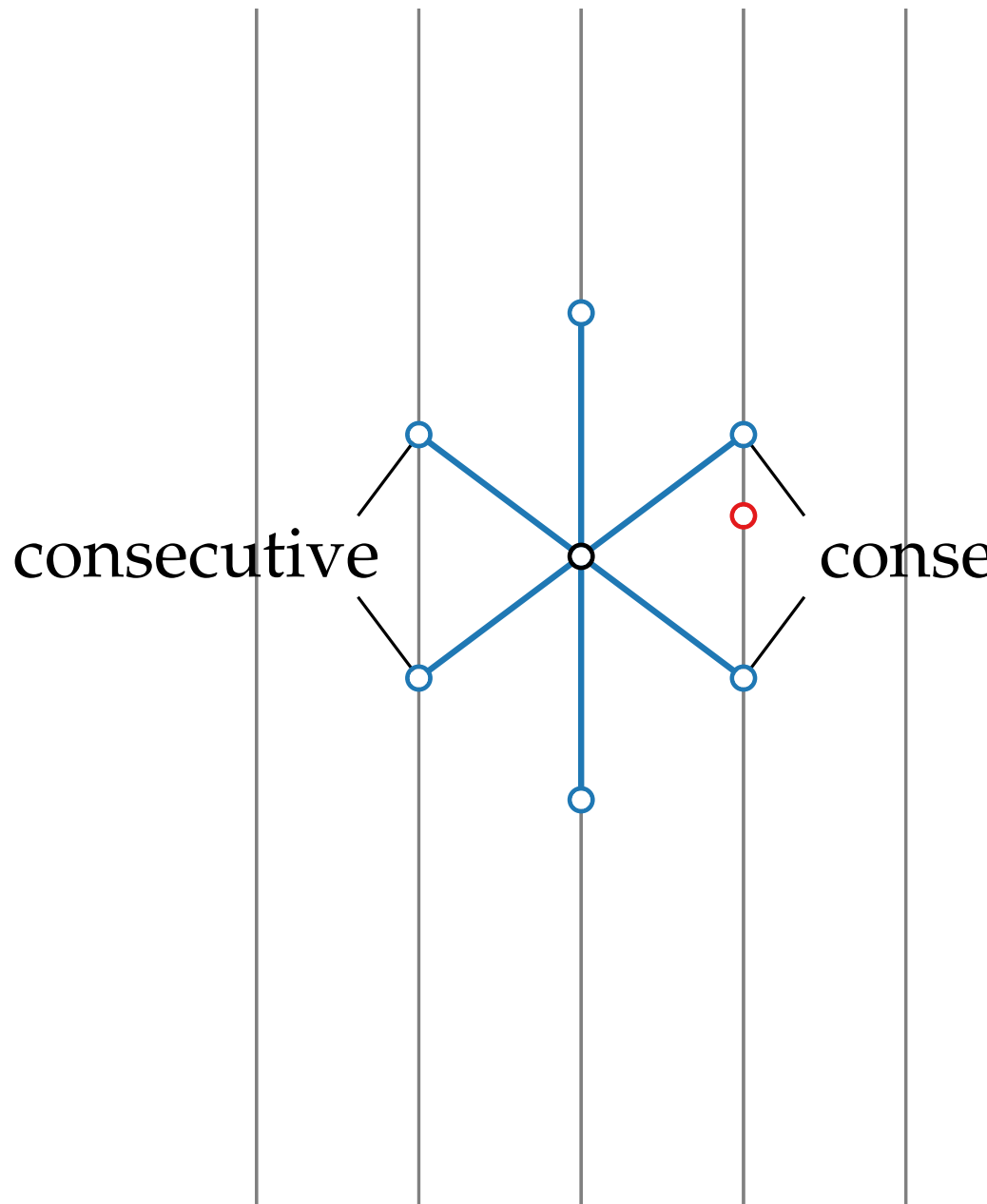
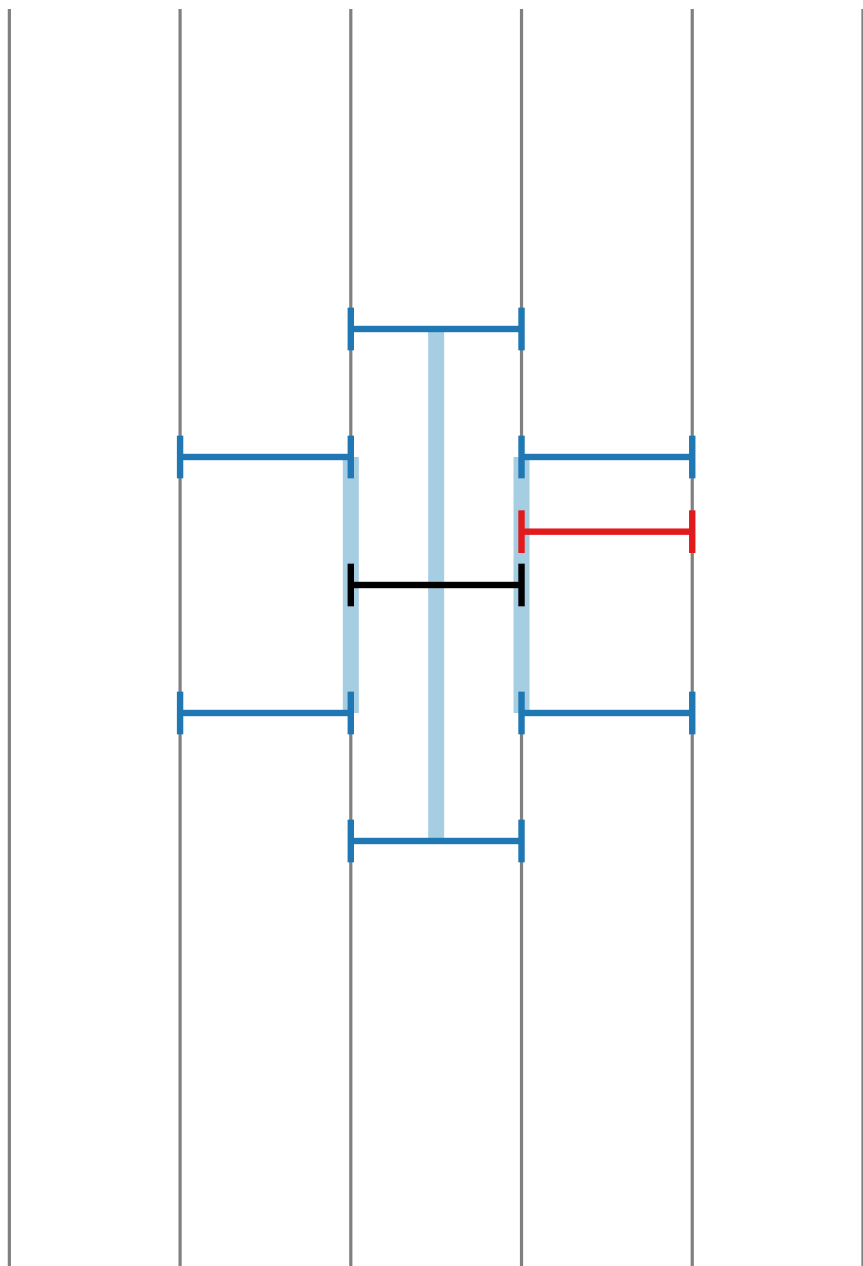

Weak: NP-hardness

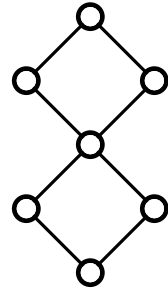

Weak: NP-hardness

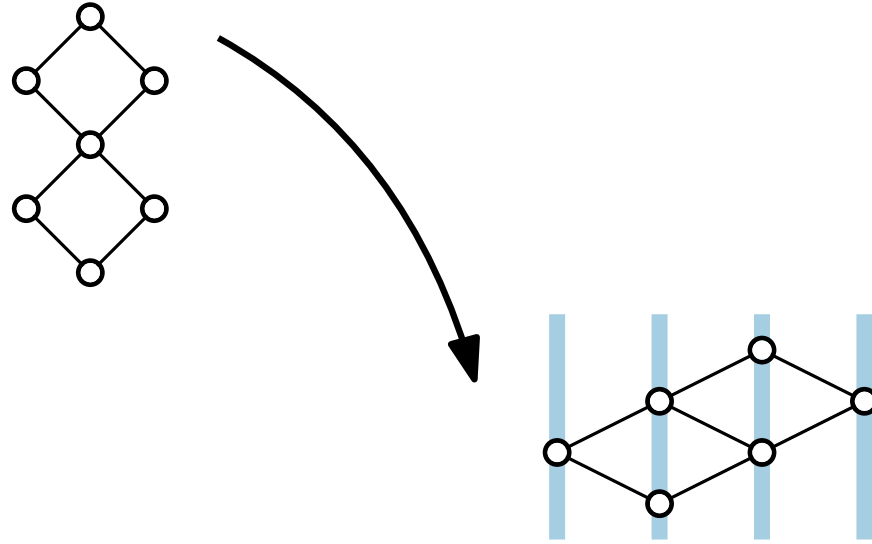

Weak: NP-hardness

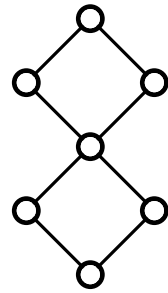

NP-hard
[Heath & Rosenberg]

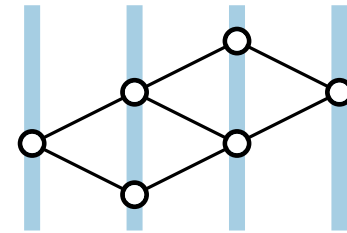

Weak: NP-hardness

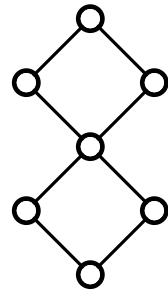

NP-hard
[Heath & Rosenberg]

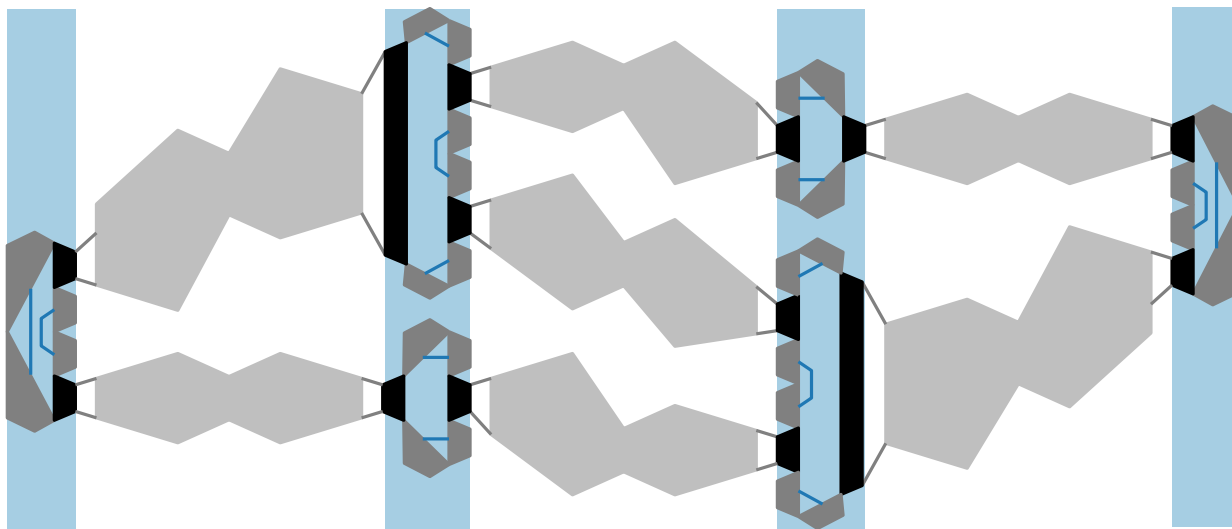
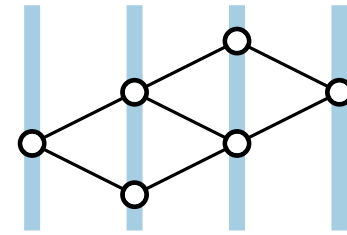

Weak: NP-hardness

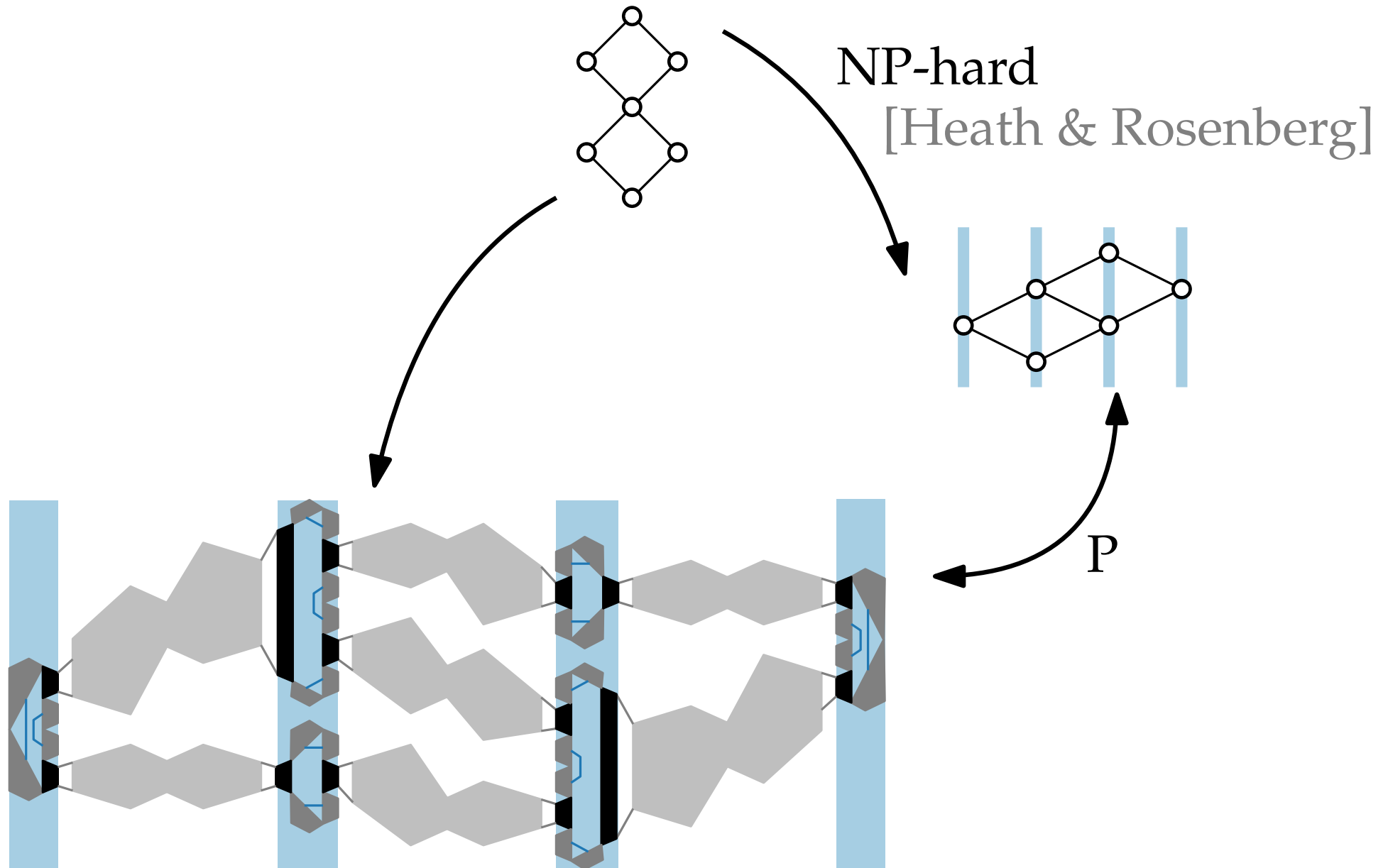

Weak: NP-hardness

Edges:

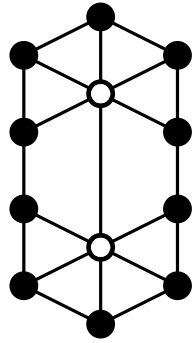

Weak: NP-hardness

Edges:

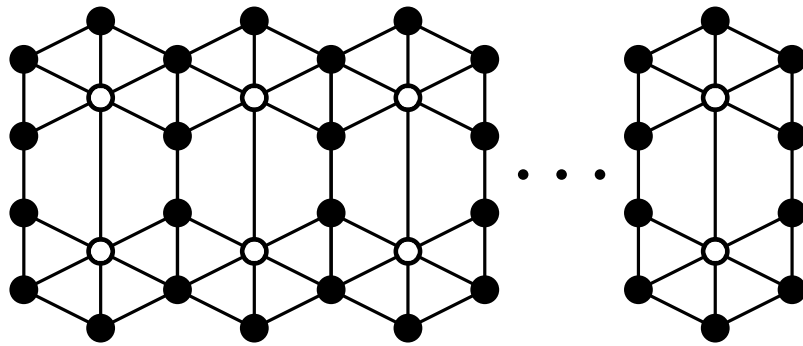

Weak: NP-hardness

Edges:

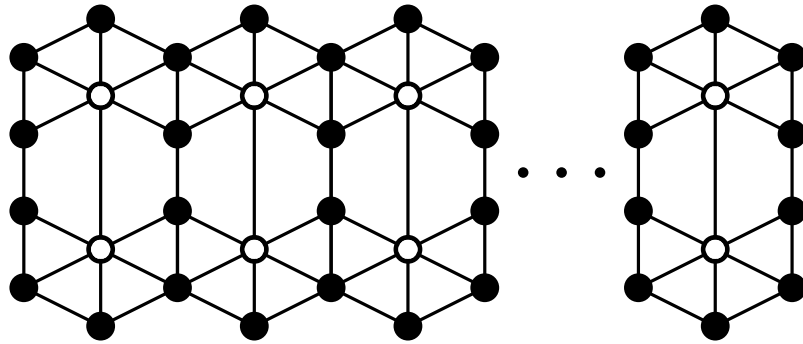

Node block:

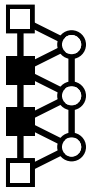

Weak: NP-hardness

Edges:

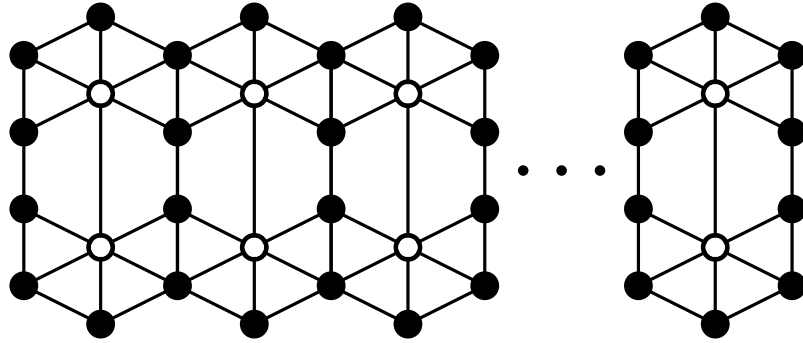

Node block:

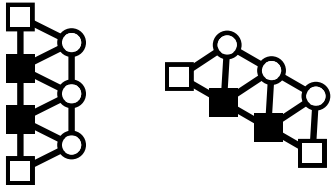

Weak: NP-hardness

Edges:

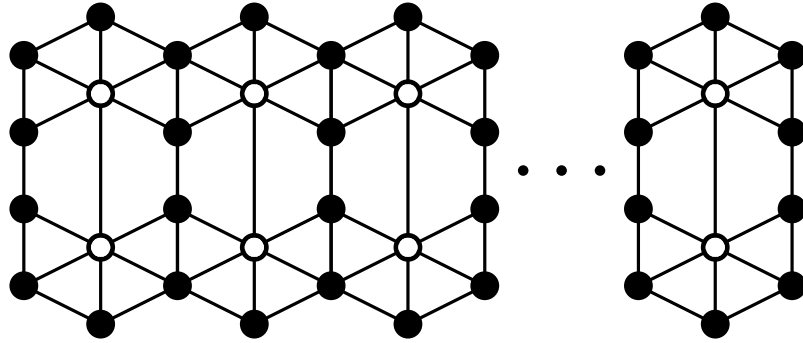

Node block:

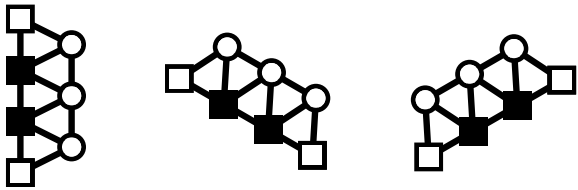

Weak: NP-hardness

Edges:

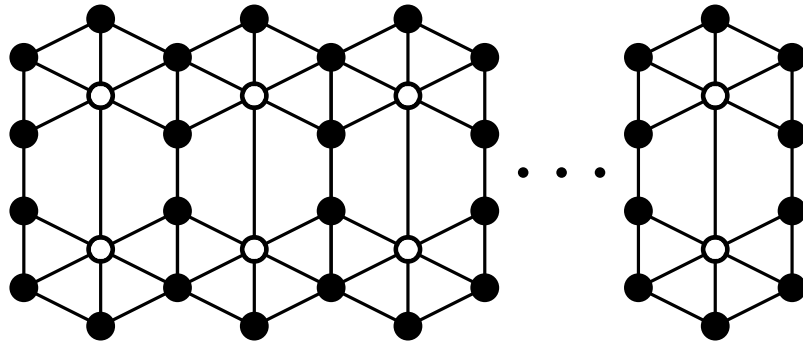

Node block:

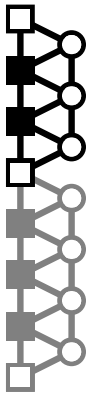

Weak: NP-hardness

Edges:

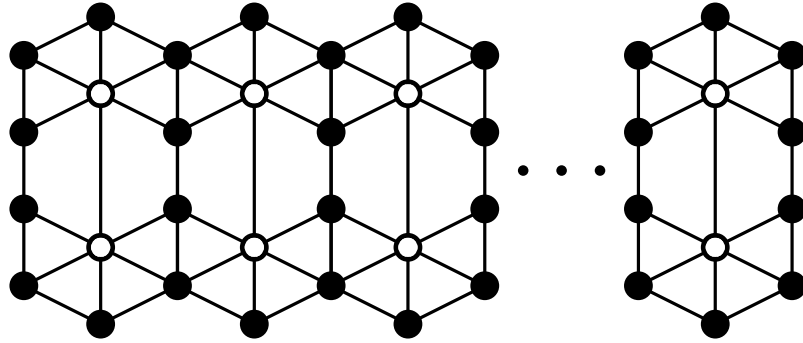

Node block:



Weak: NP-hardness

Edges:

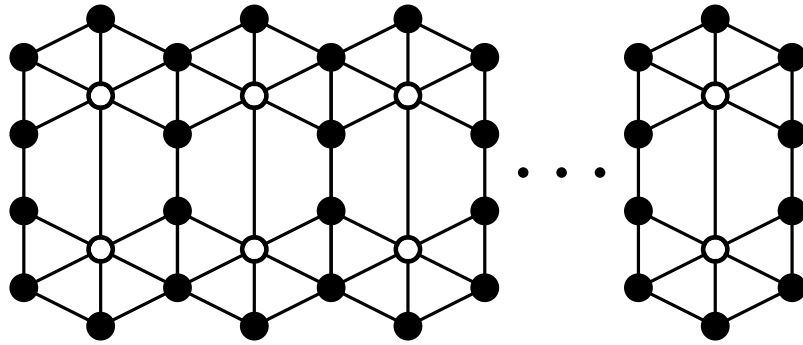

Node block:

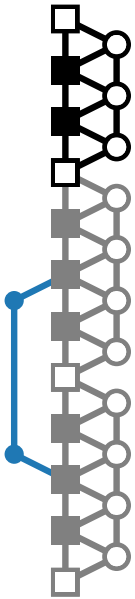

Weak: NP-hardness

Edges:

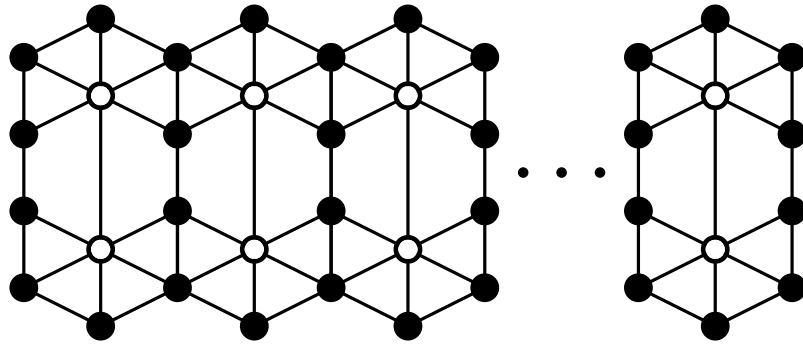

Node block:

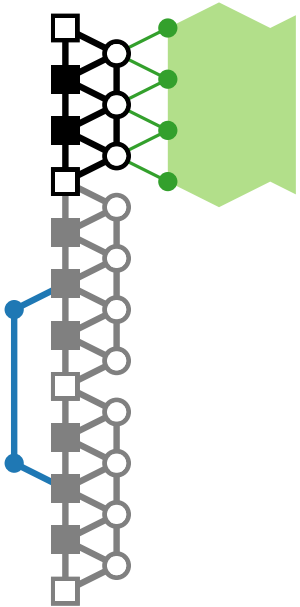

Weak: NP-hardness

Edges:

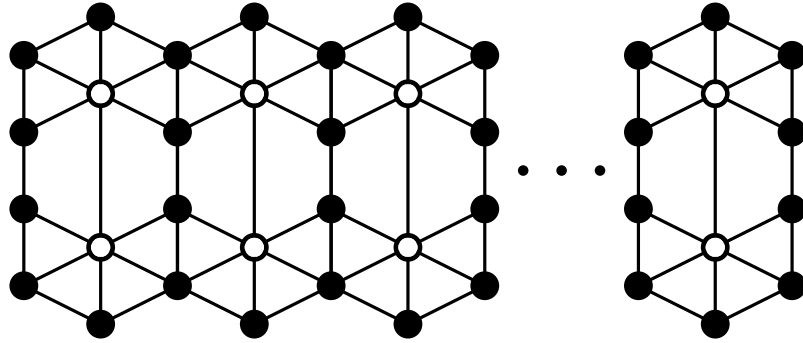

Node block:

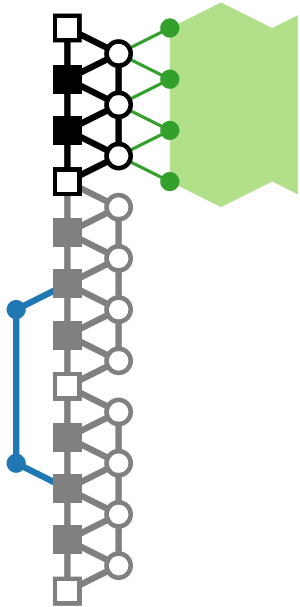

Nodes:

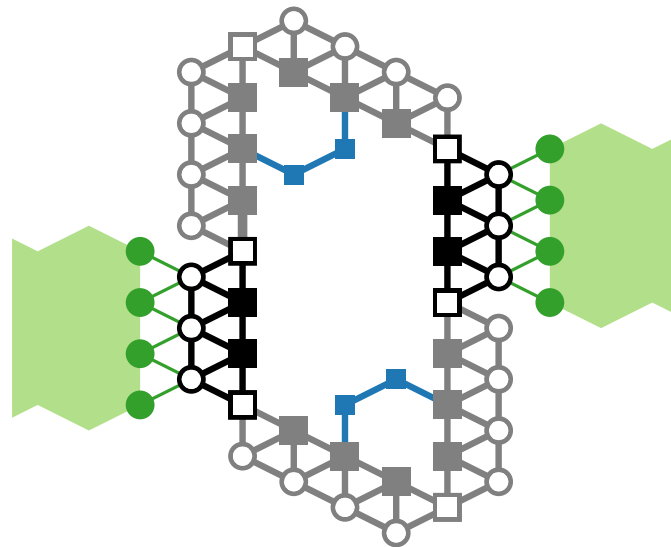

Weak: NP-hardness

Edges:

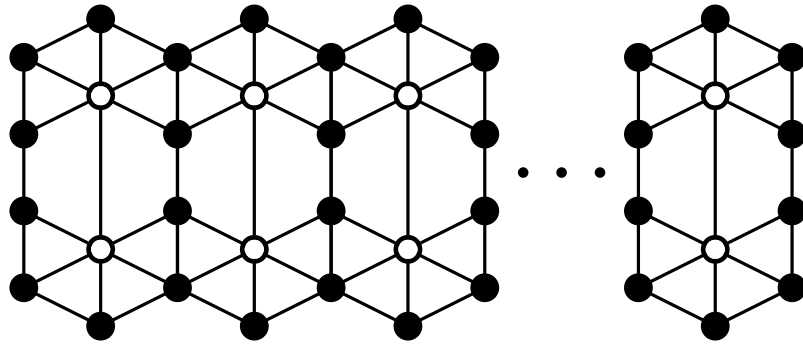

Node block:

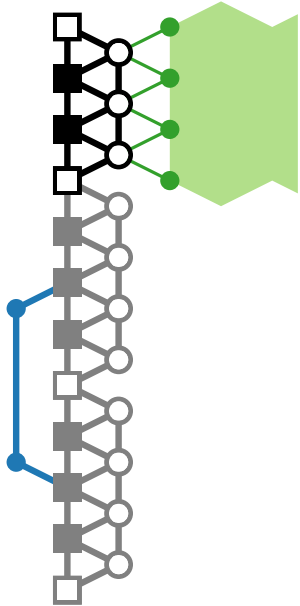

Nodes:

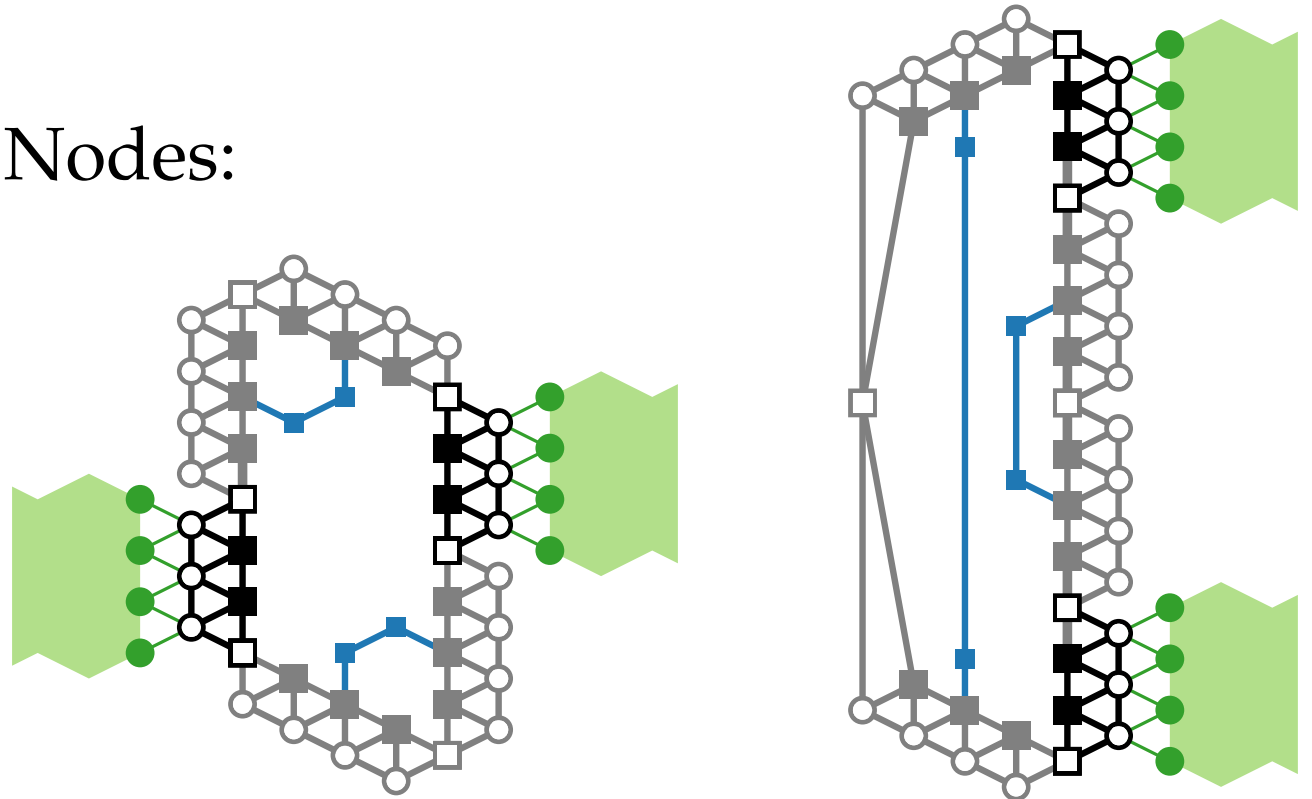

Weak: NP-hardness

Edges:

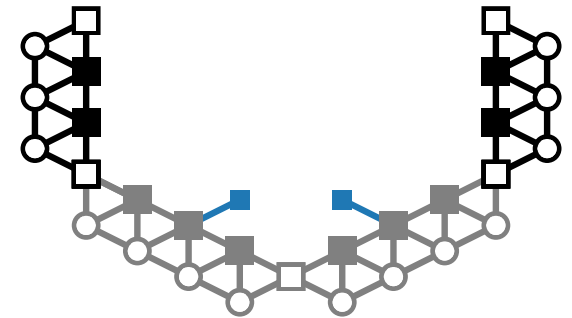
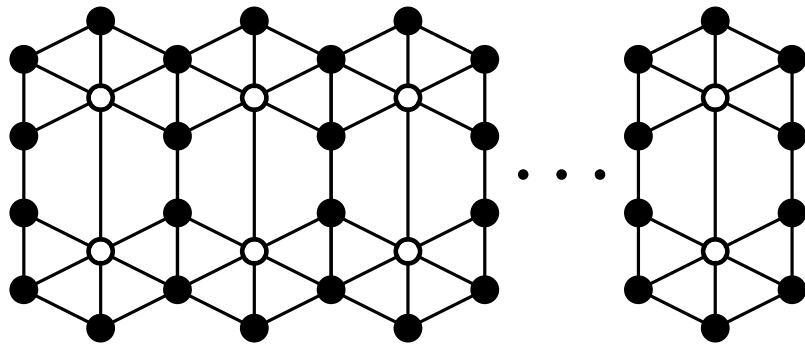

Node block:

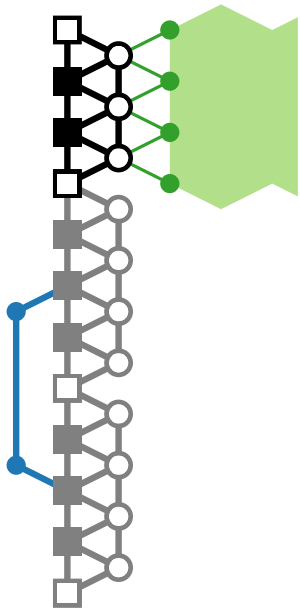

Nodes:

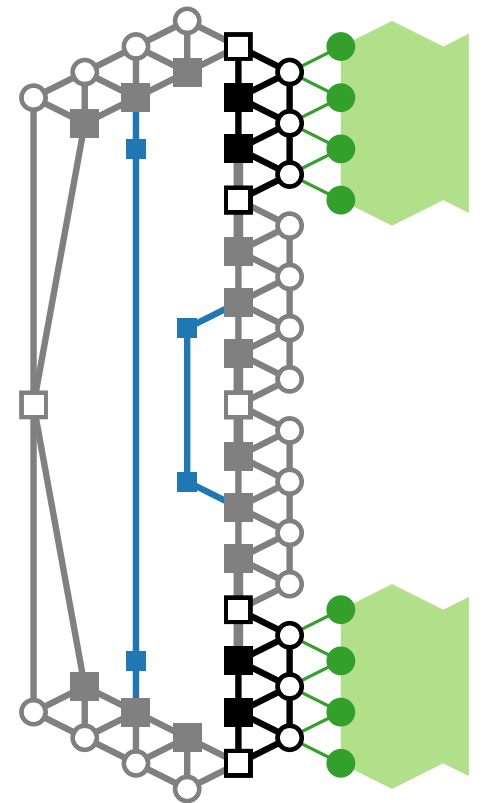
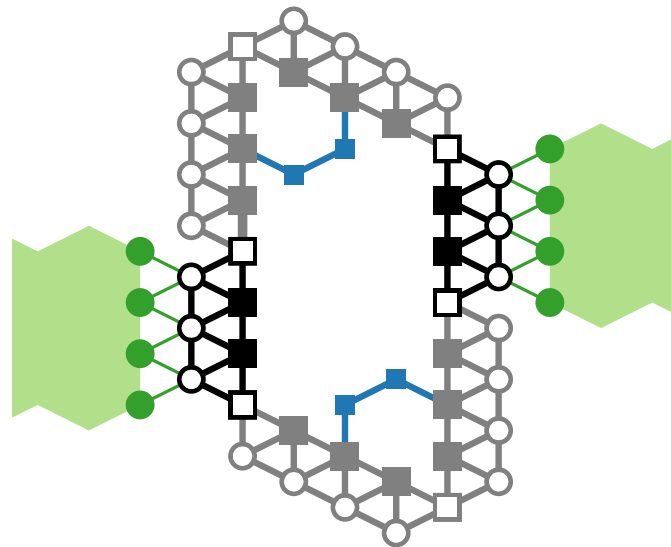

Weak: NP-hardness

Edges:

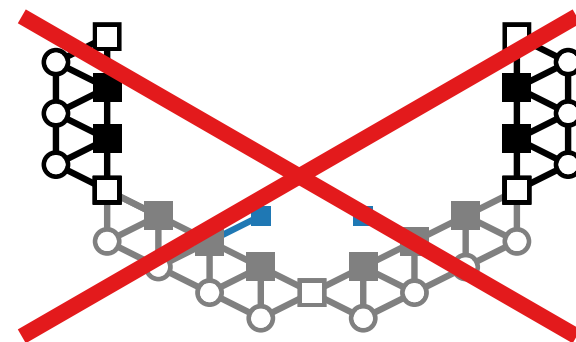
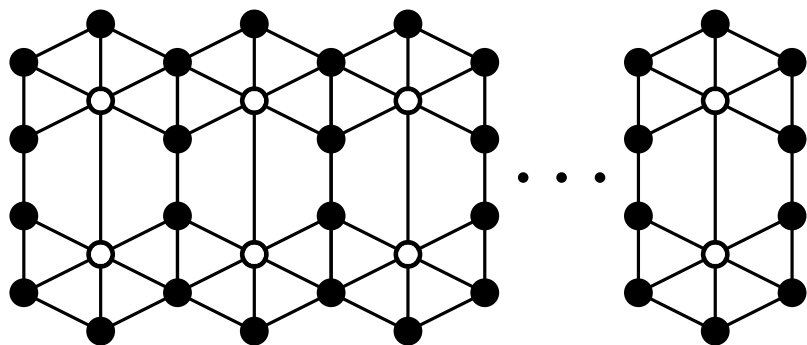

Node block:

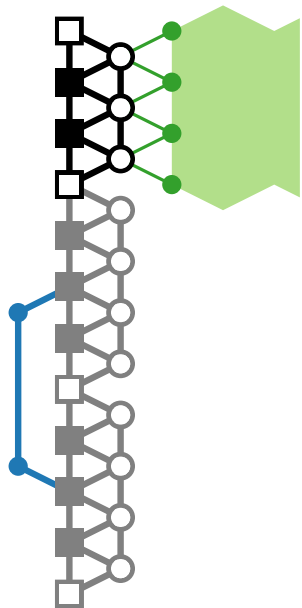

Nodes:

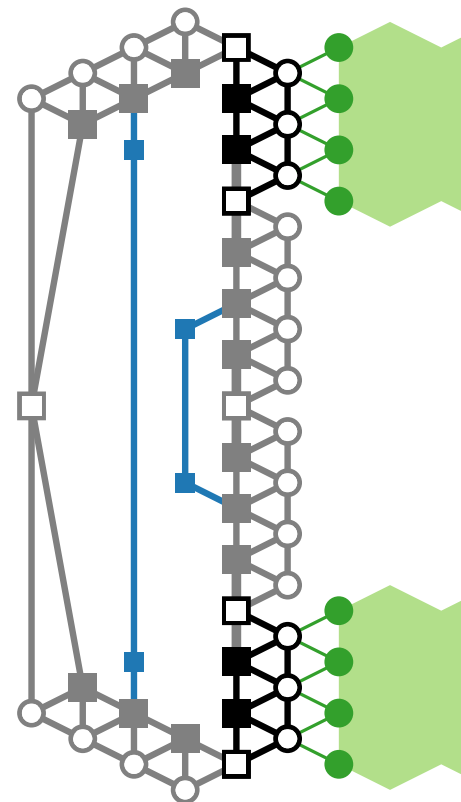
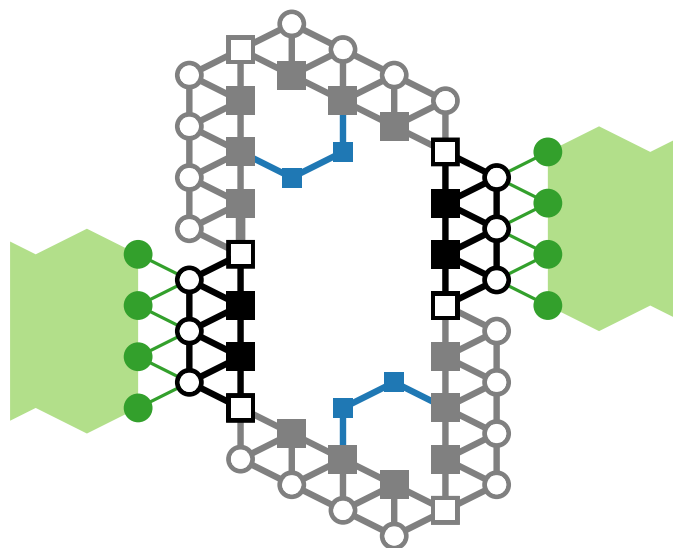

Weak: NP-hardness

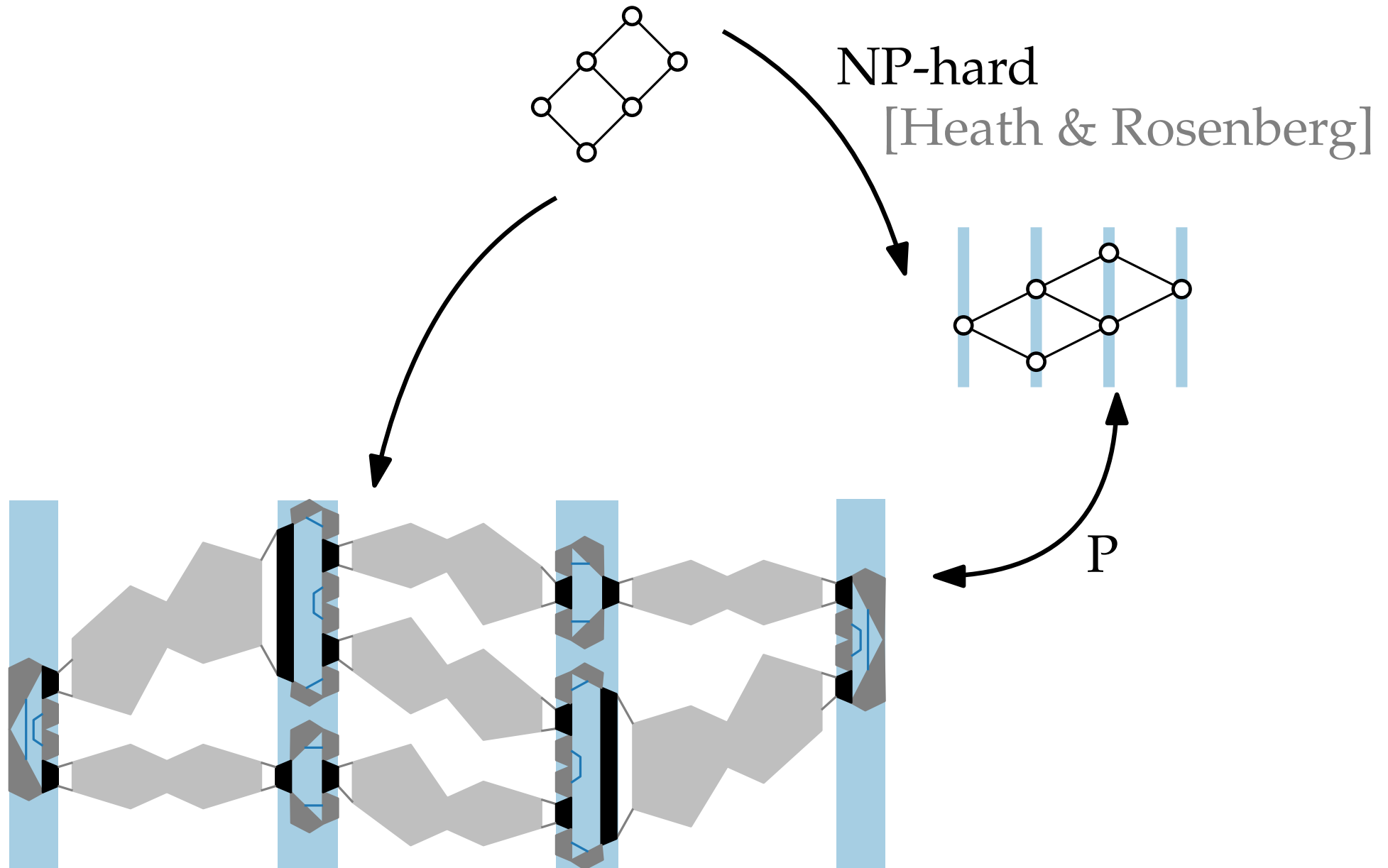

Weak: NP-hardness

Recognition:
NP-hard

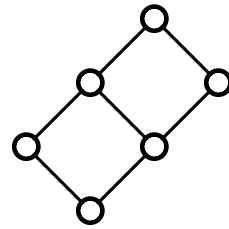

NP-hard
[Heath & Rosenberg]

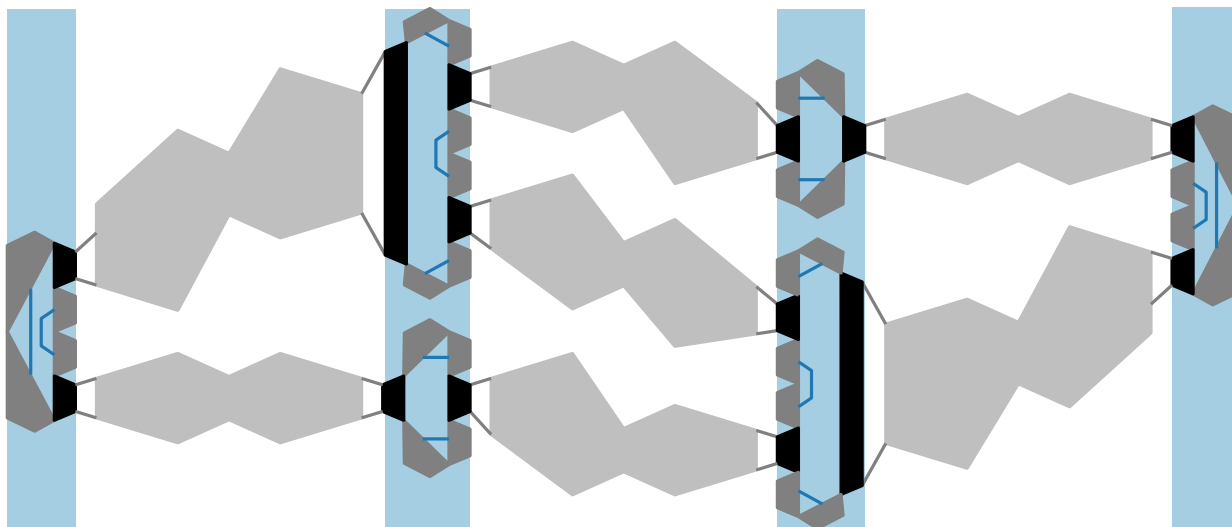
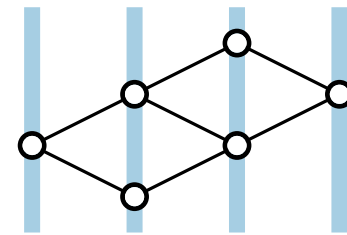

P

Strong Model

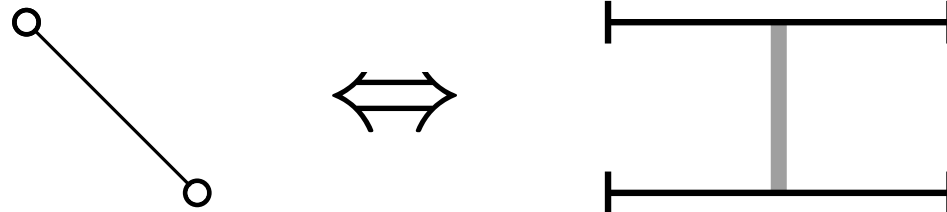

Strong: Trees

[Dean & Veytsel]

Unit Bar-Visibility Representation

\Leftrightarrow maxdeg 3, subdivision of caterpillar

Strong: Trees

[Dean & Veytsel]

Unit Bar-Visibility Representation

\Leftrightarrow maxdeg 3, subdivision of caterpillar

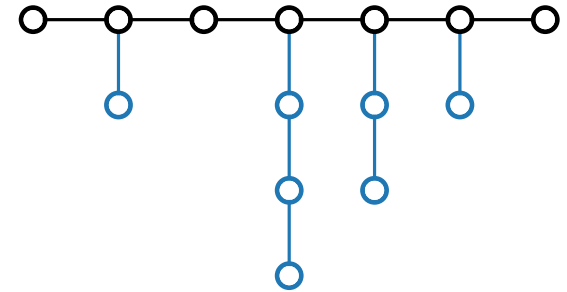

Strong: Trees

[Dean & Veytsel]

Unit Bar-Visibility Representation

\Leftrightarrow maxdeg 3, subdivision of caterpillar

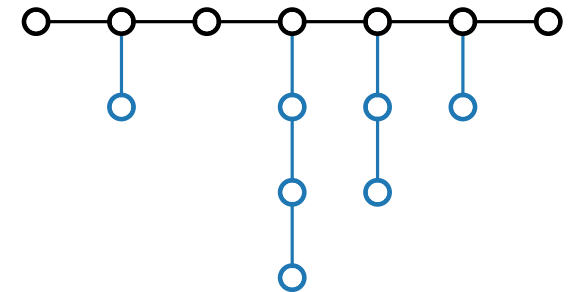
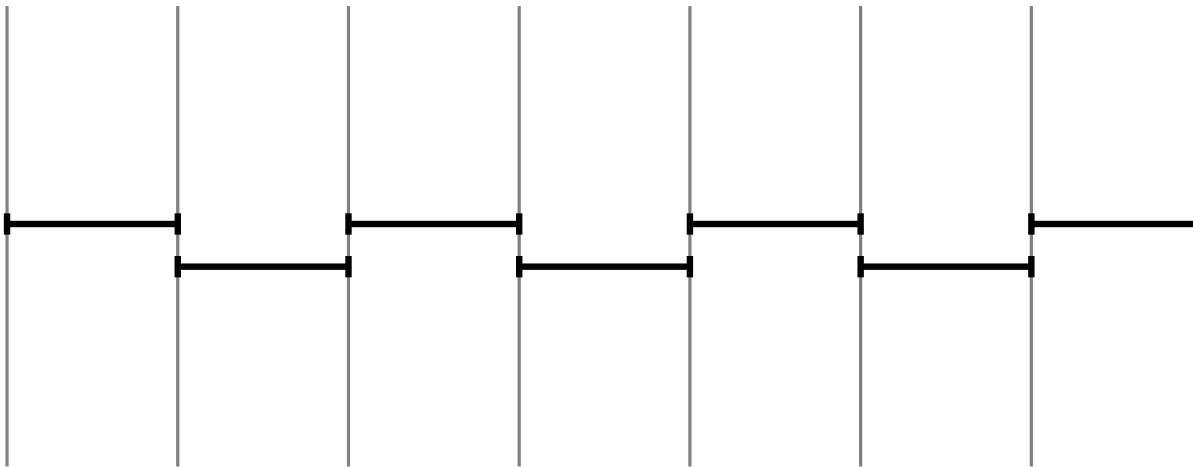

Strong: Trees

[Dean & Veytsel]

Unit Bar-Visibility Representation

\Leftrightarrow maxdeg 3, subdivision of caterpillar

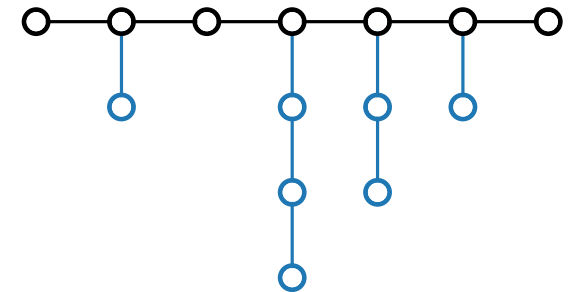
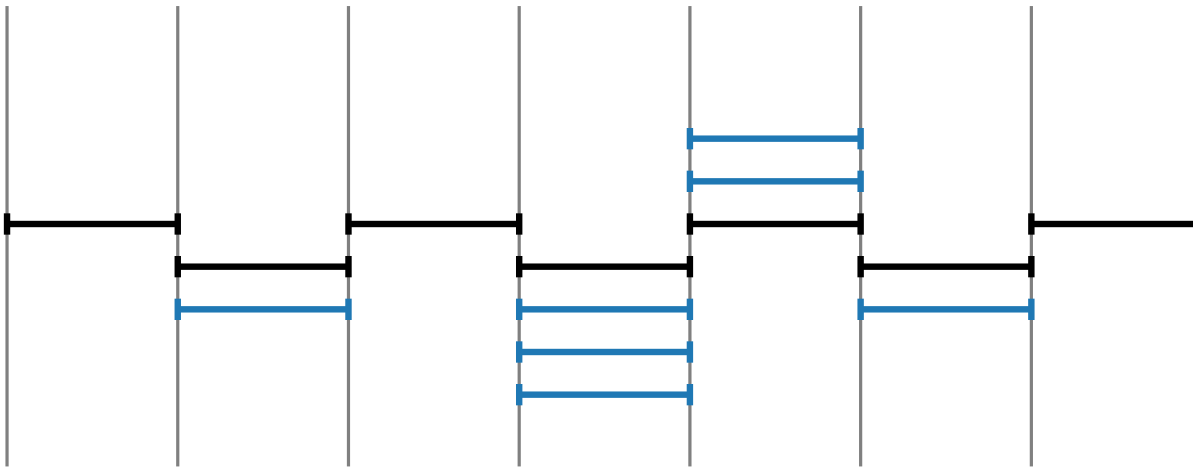

Strong: Trees

[Dean & Veytsel]

Unit Bar-Visibility Representation

\Leftrightarrow maxdeg 3, subdivision of caterpillar

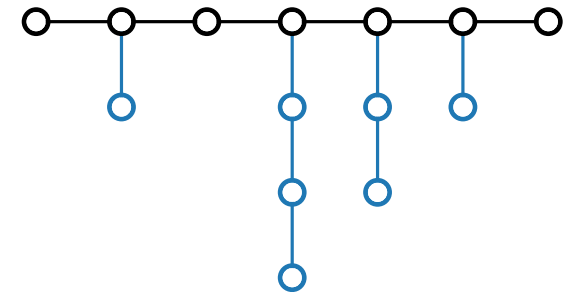
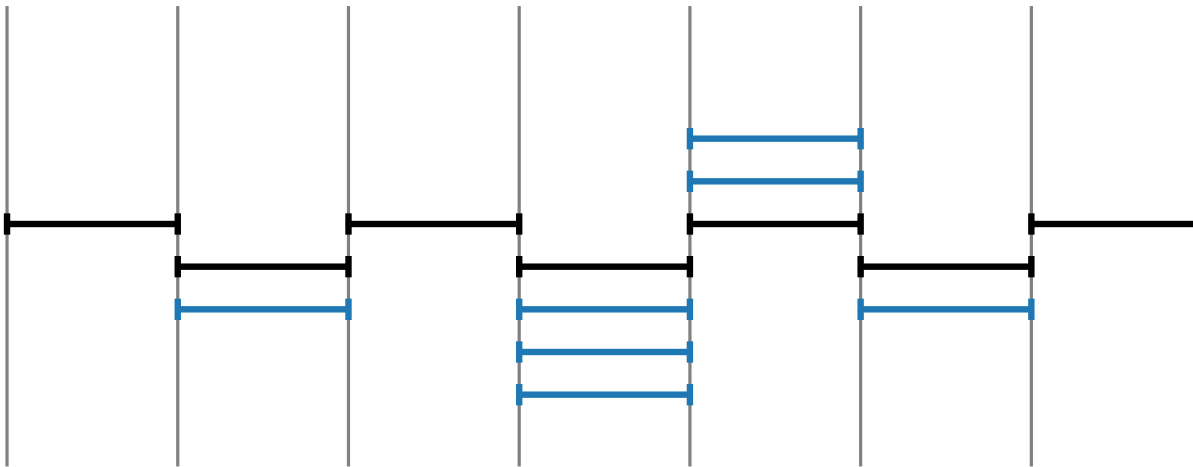

Integral

Unit Bar-Visibility Representation

\Leftrightarrow maxdeg 3, subdivision of caterpillar

Strong: Biconnected Graphs

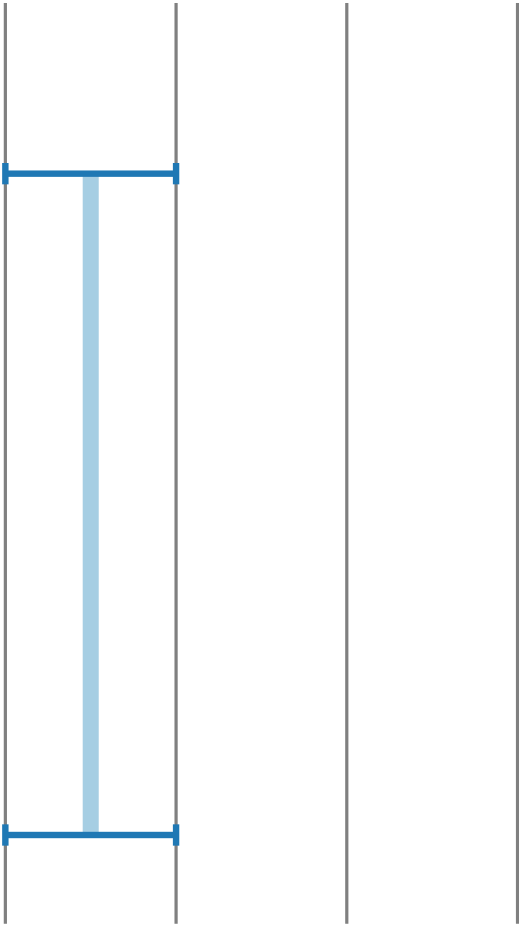

Strong: Biconnected Graphs

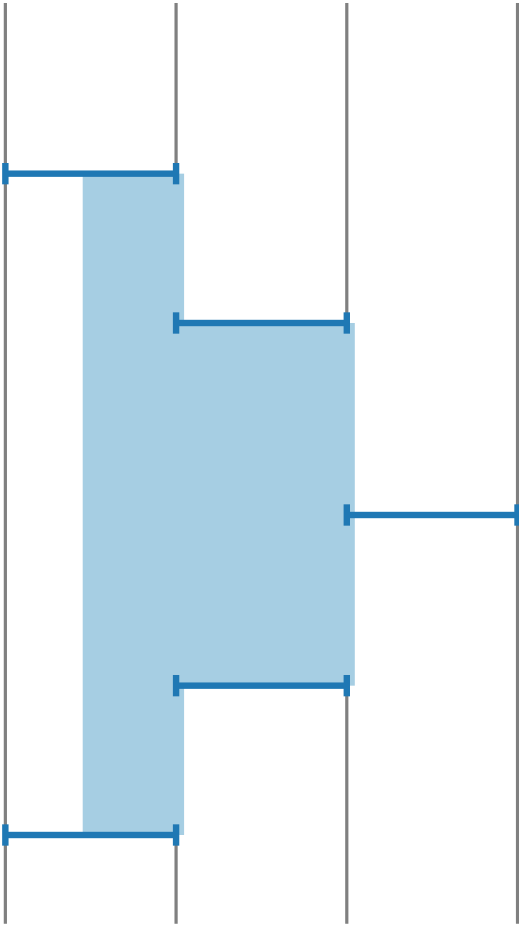

Strong: Biconnected Graphs

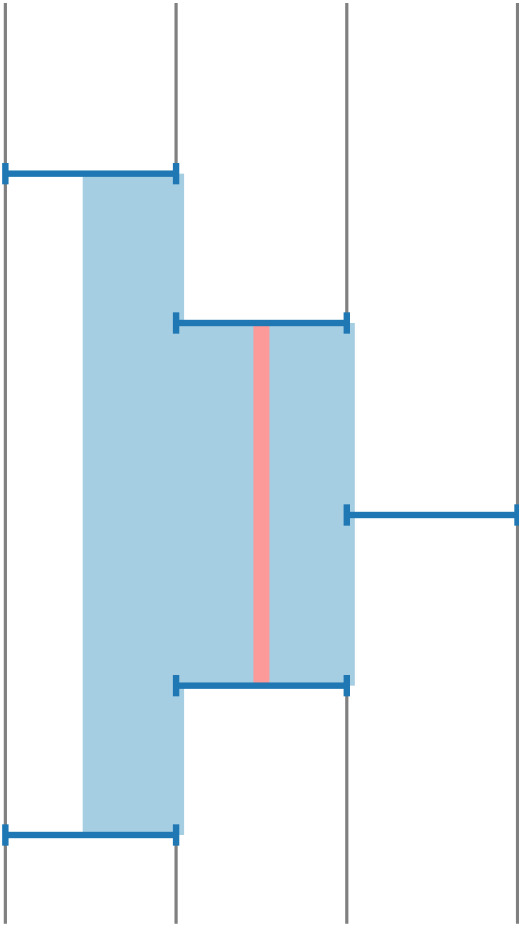

Strong: Biconnected Graphs

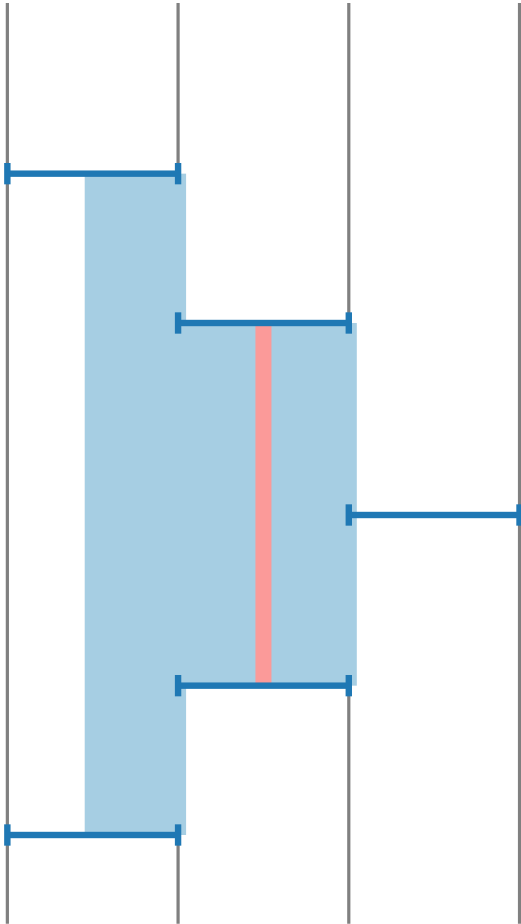

Every face spans two slabs

Strong: Biconnected Graphs

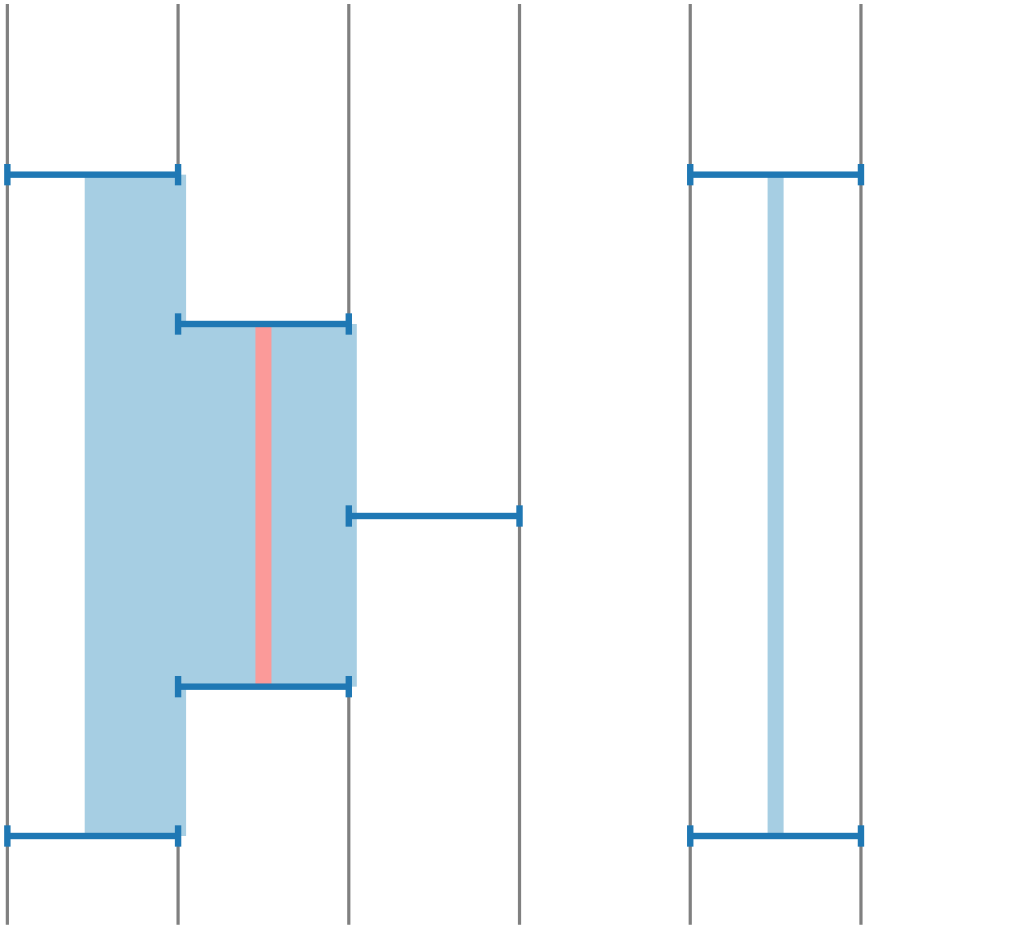

Every face spans two slabs

Strong: Biconnected Graphs

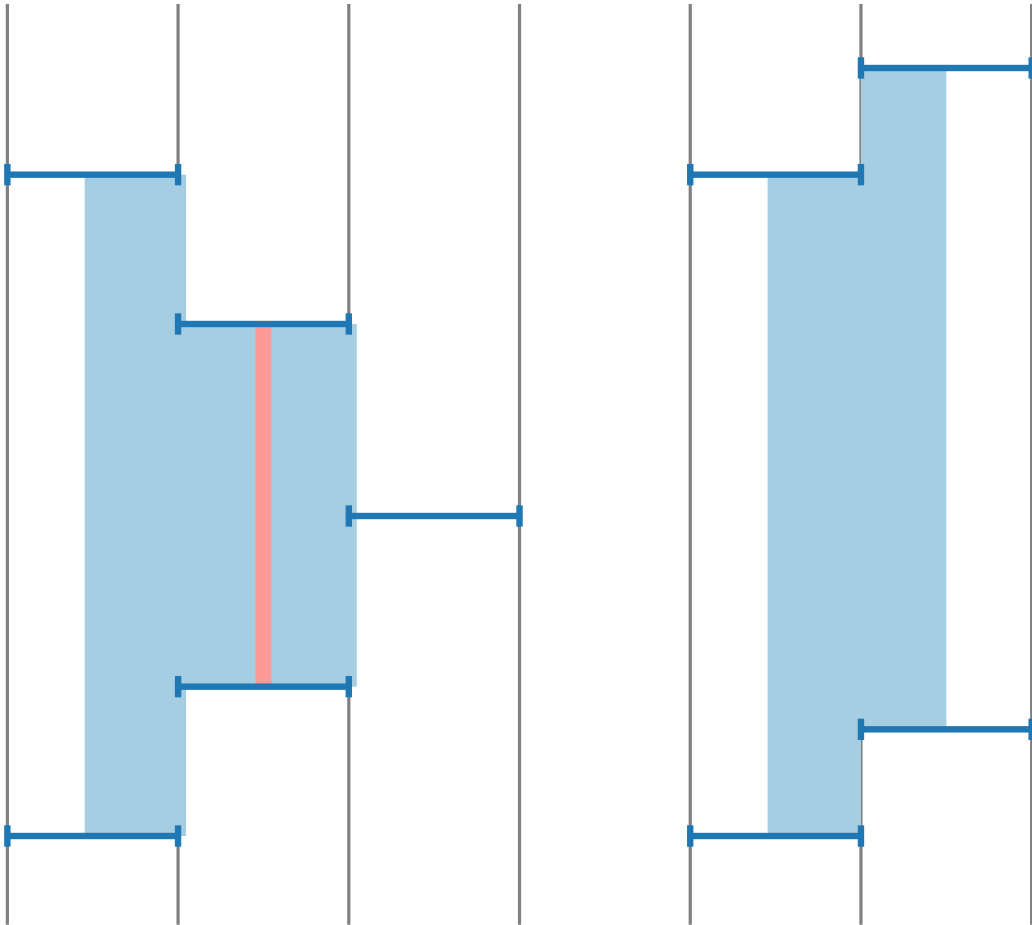

Every face spans two slabs

Strong: Biconnected Graphs

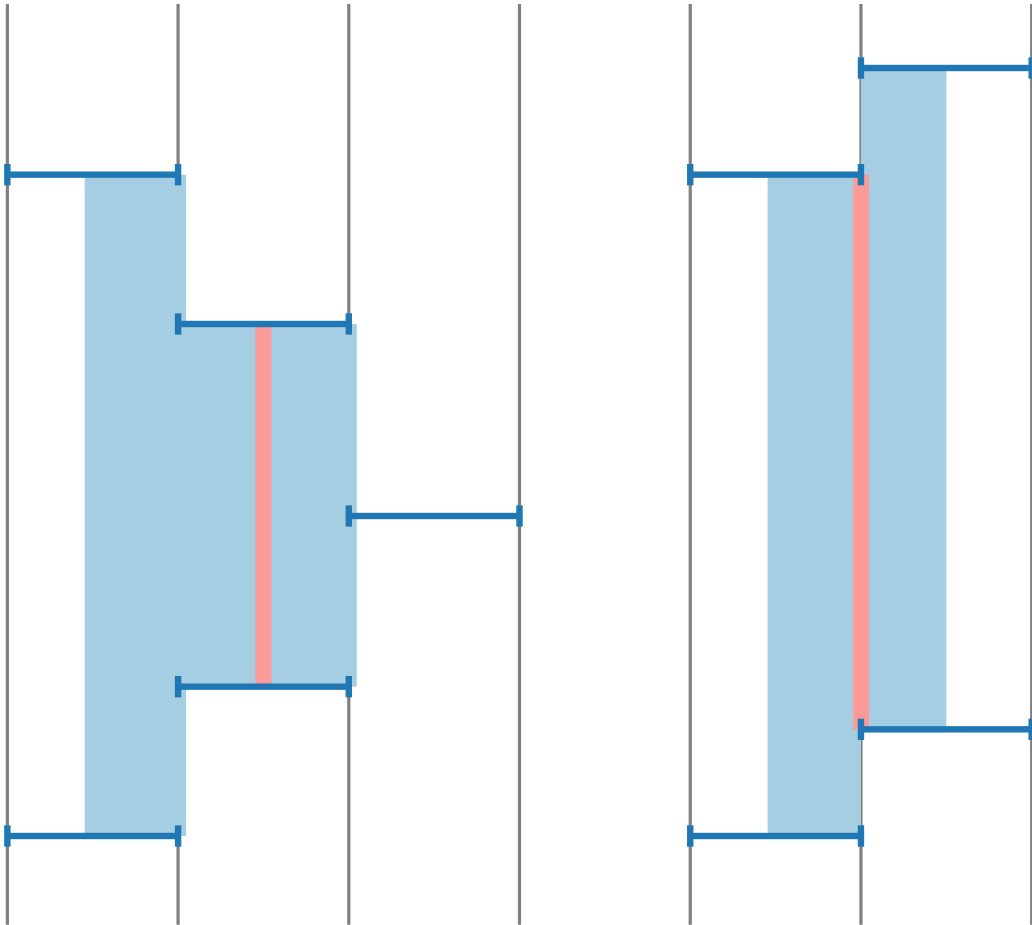

Every face spans two slabs

Strong: Biconnected Graphs

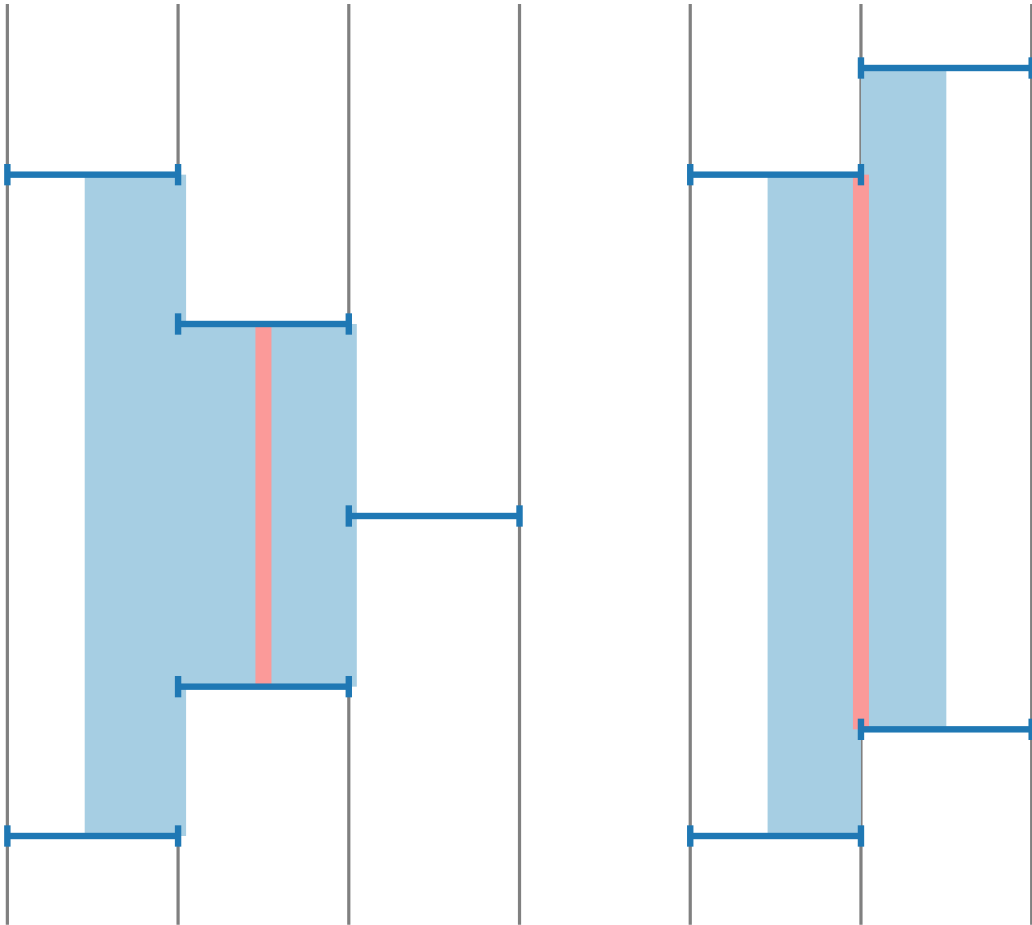

Every face spans two slabs

Strong: Biconnected Graphs

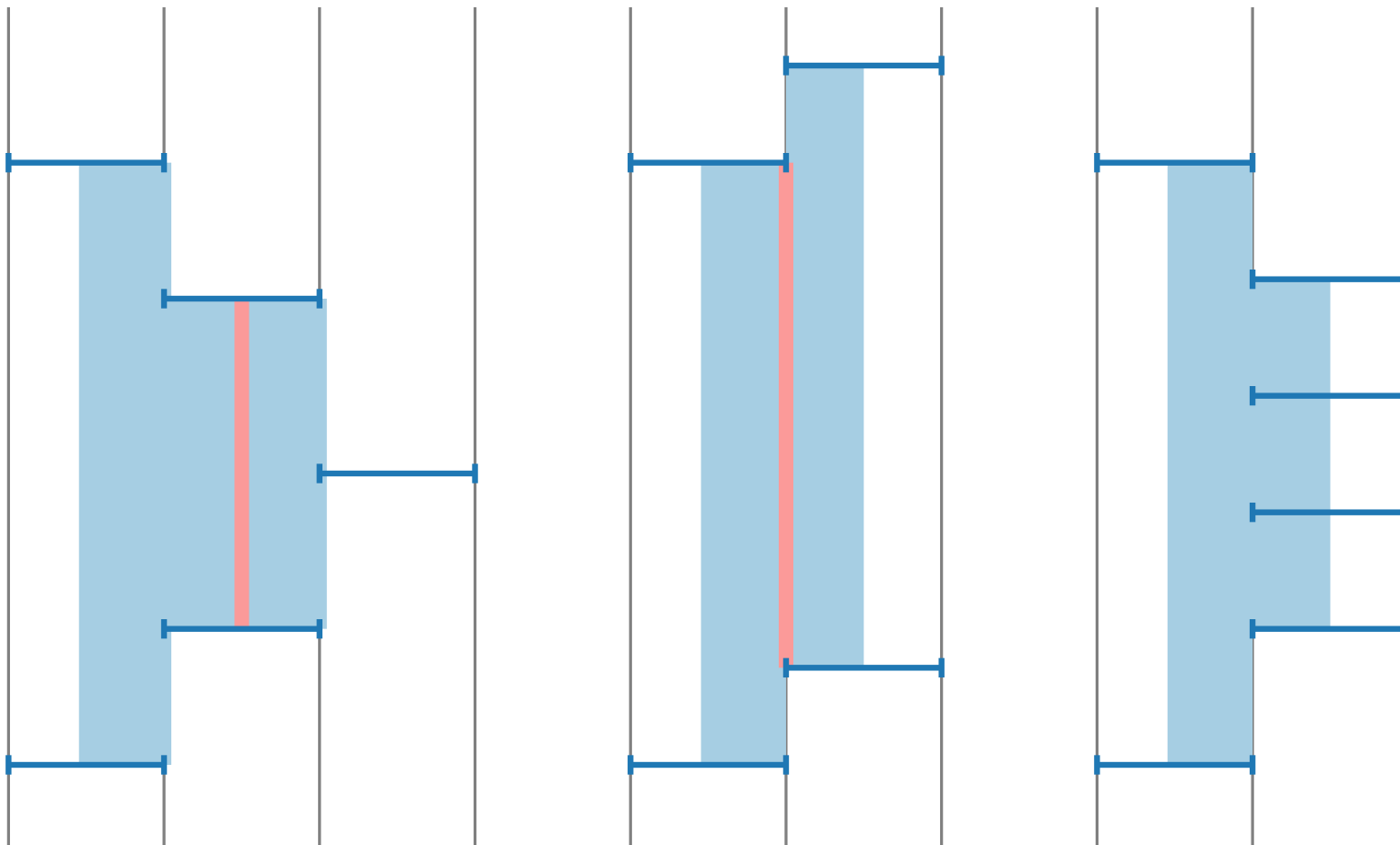

Every face spans two slabs

Strong: Biconnected Graphs

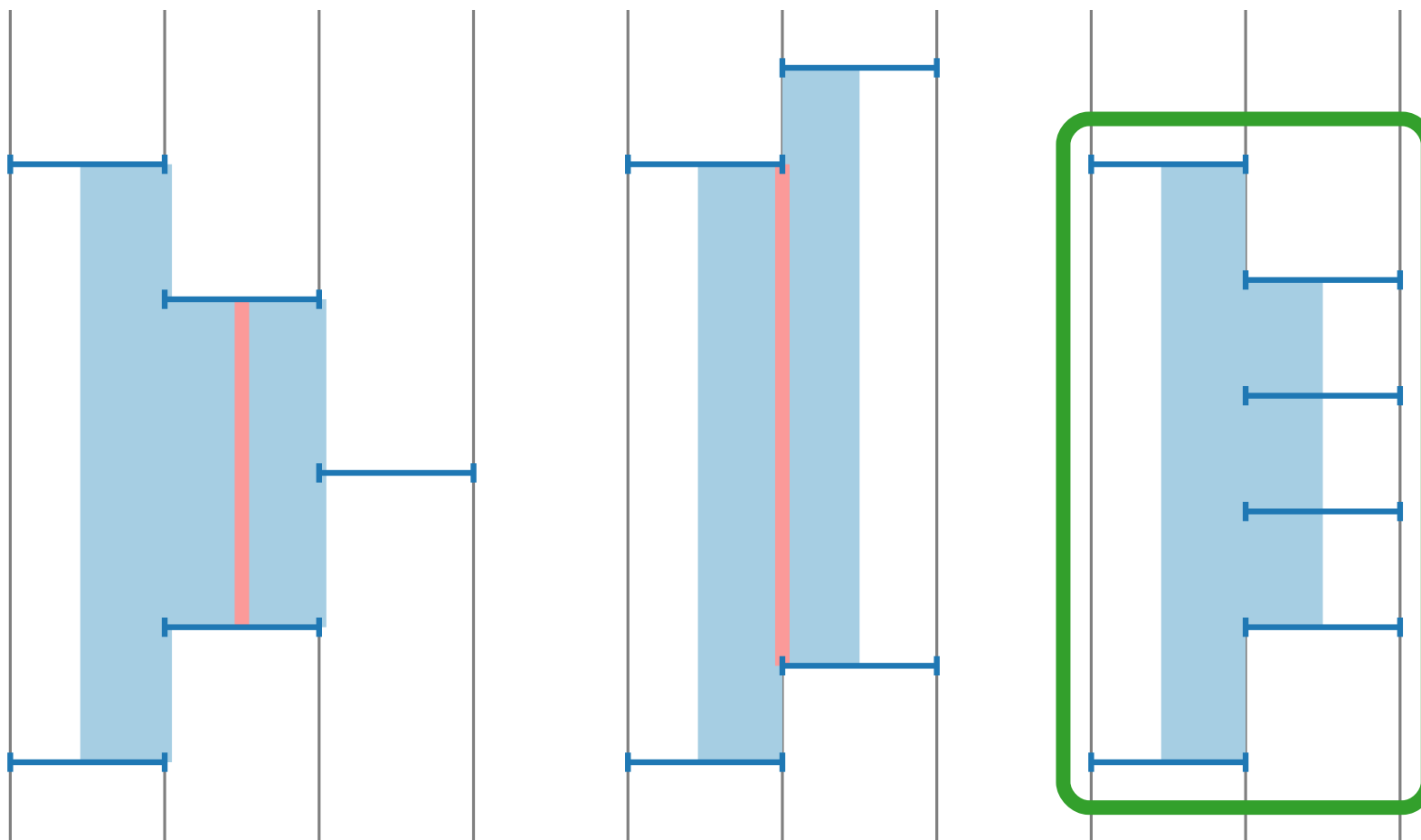

Every face spans two slabs and is a trapezoid

Strong: Biconnected Graphs

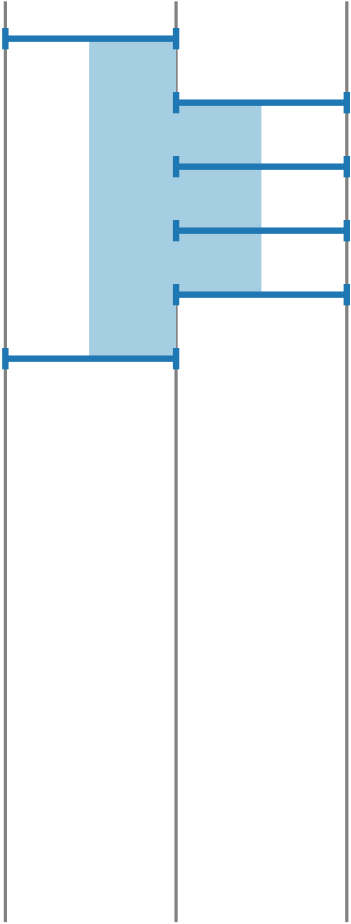

Strong: Biconnected Graphs

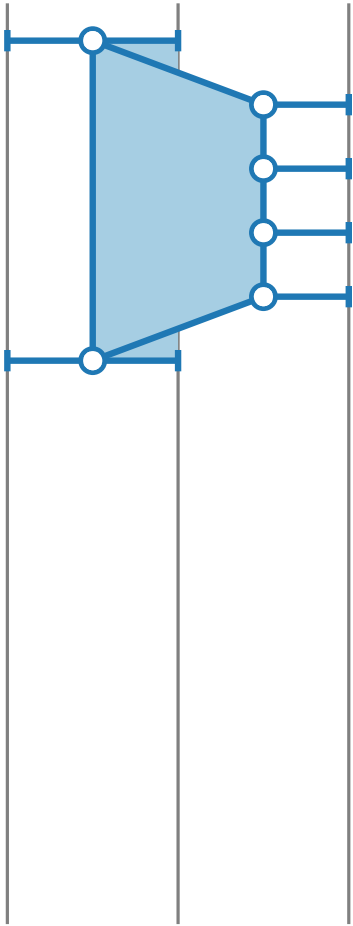

Strong: Biconnected Graphs

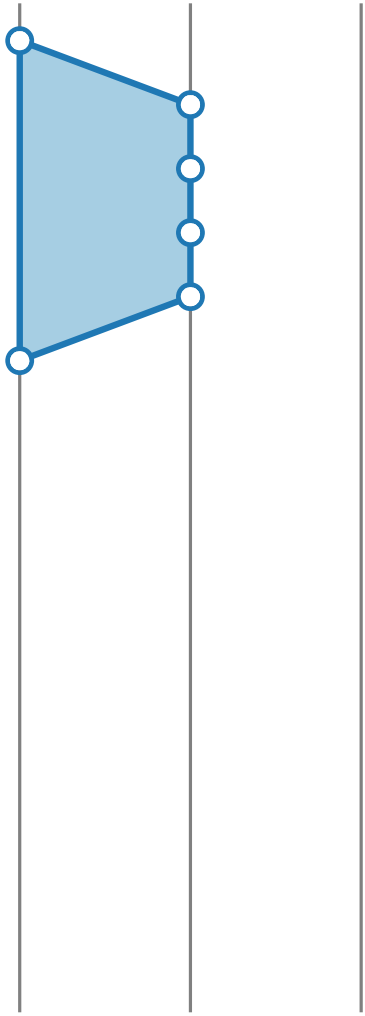

Strong: Biconnected Graphs

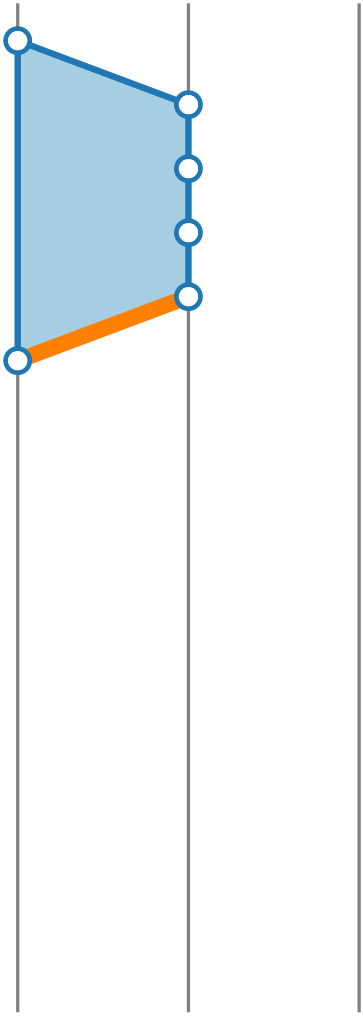

Strong: Biconnected Graphs

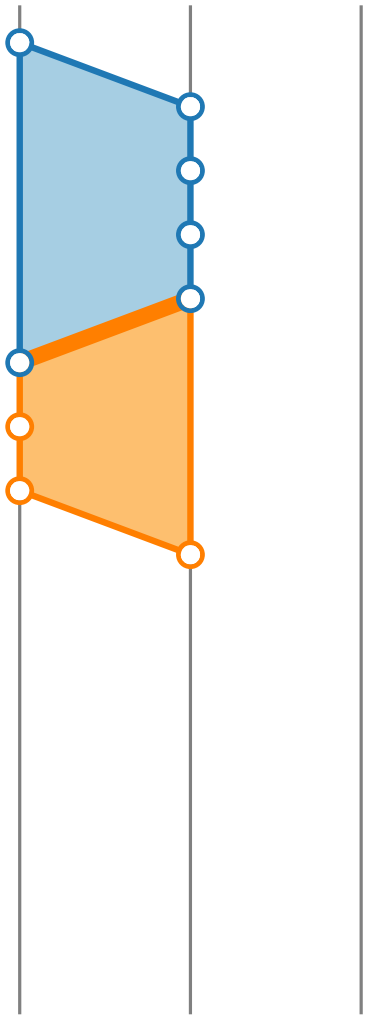

Strong: Biconnected Graphs

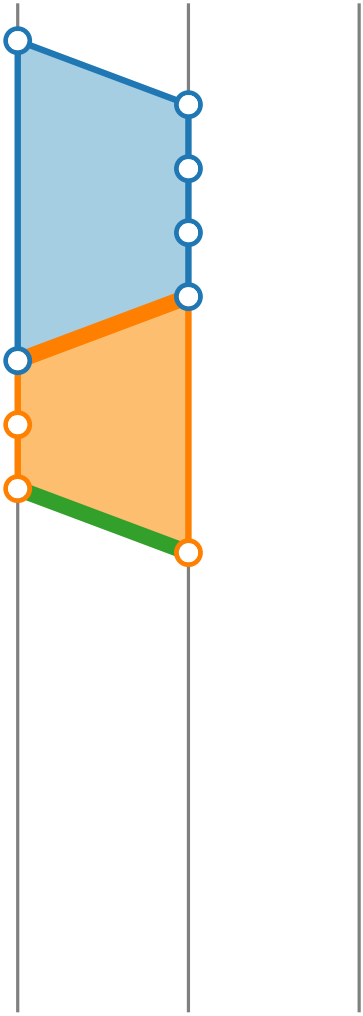

Strong: Biconnected Graphs

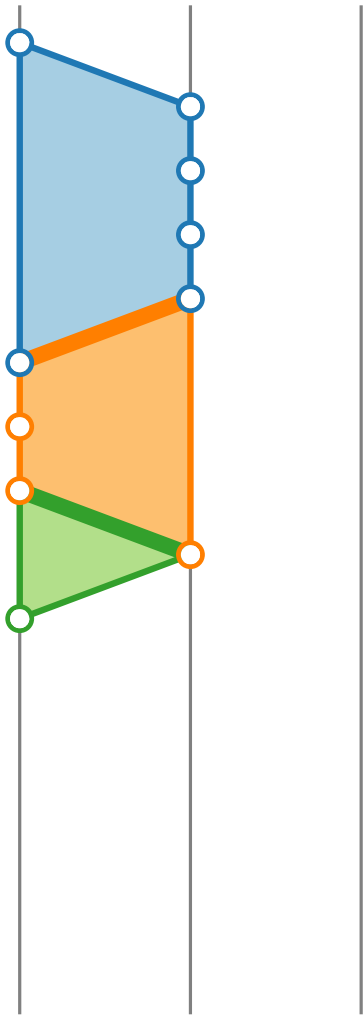

Strong: Biconnected Graphs

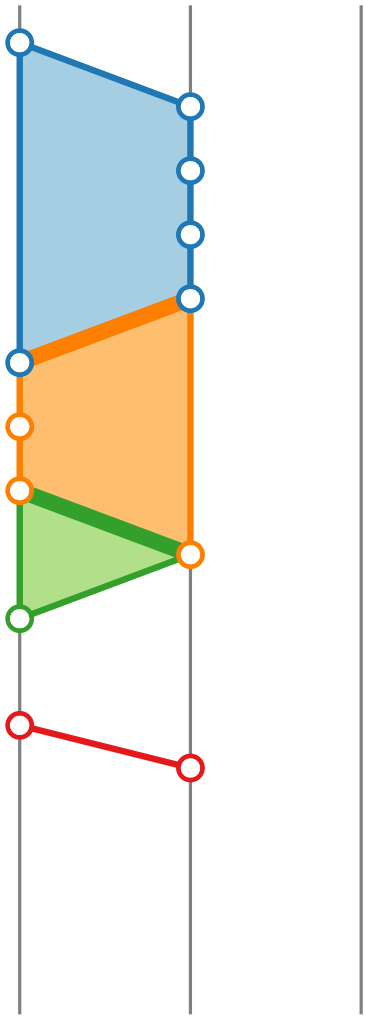

Strong: Biconnected Graphs

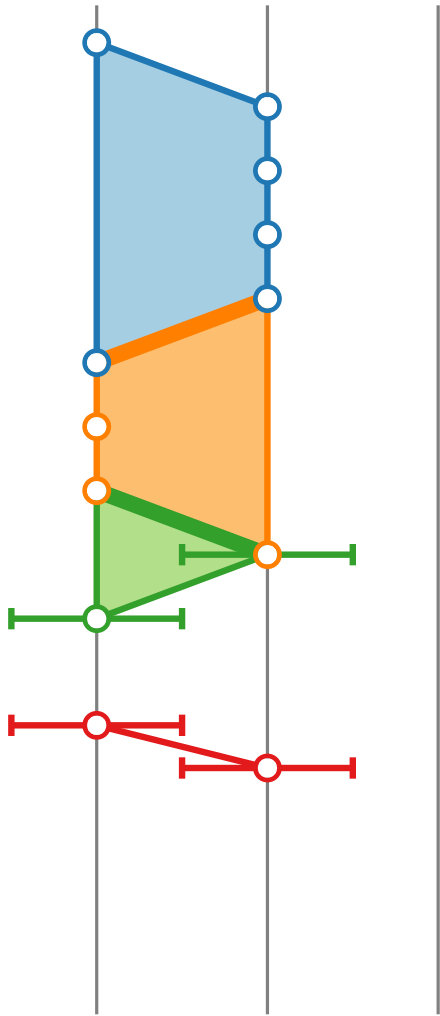

Strong: Biconnected Graphs

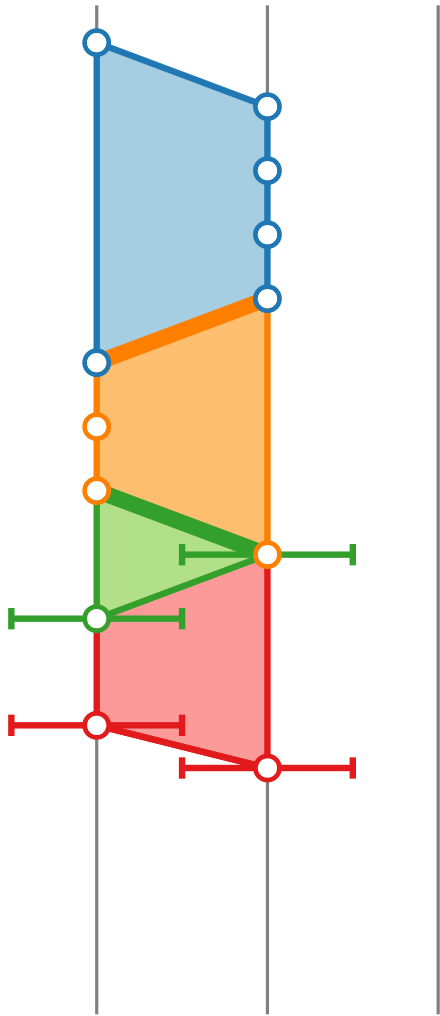

Strong: Biconnected Graphs

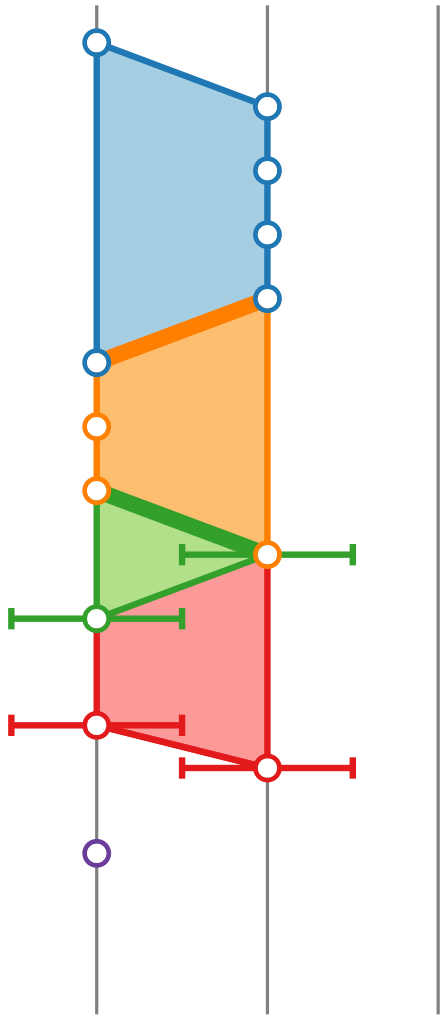

Strong: Biconnected Graphs

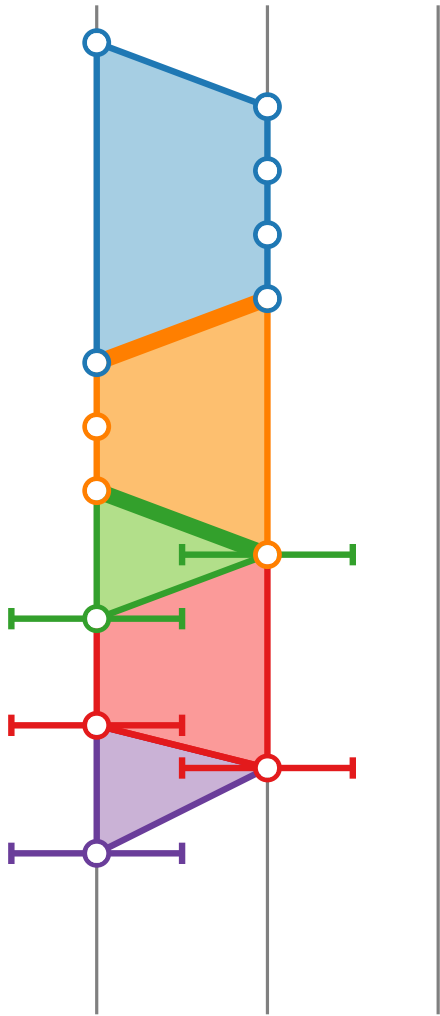

Strong: Biconnected Graphs

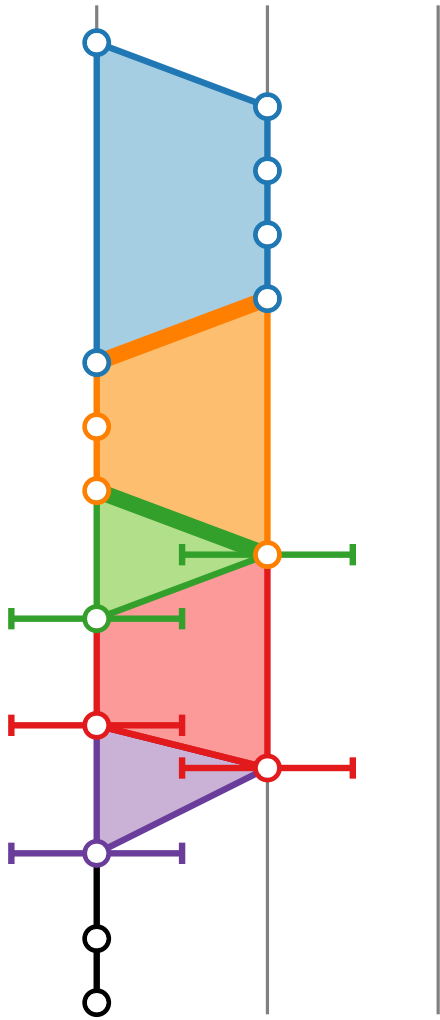

Strong: Biconnected Graphs

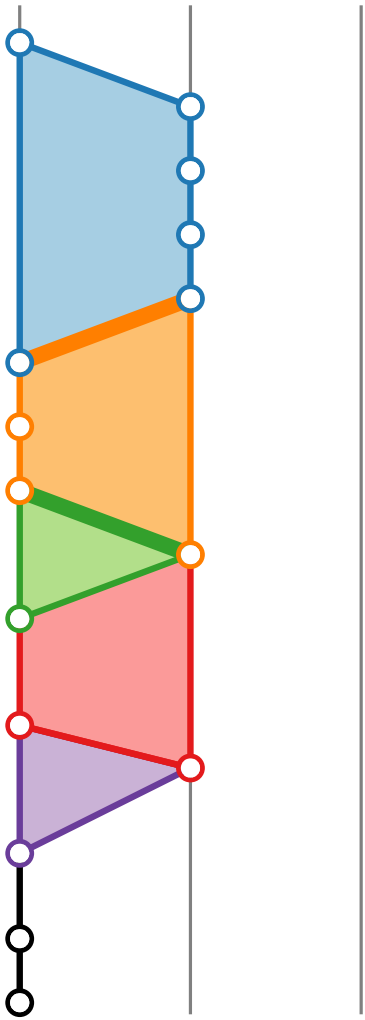

Fixing one diagonal fixes the whole slab

Strong: Biconnected Graphs

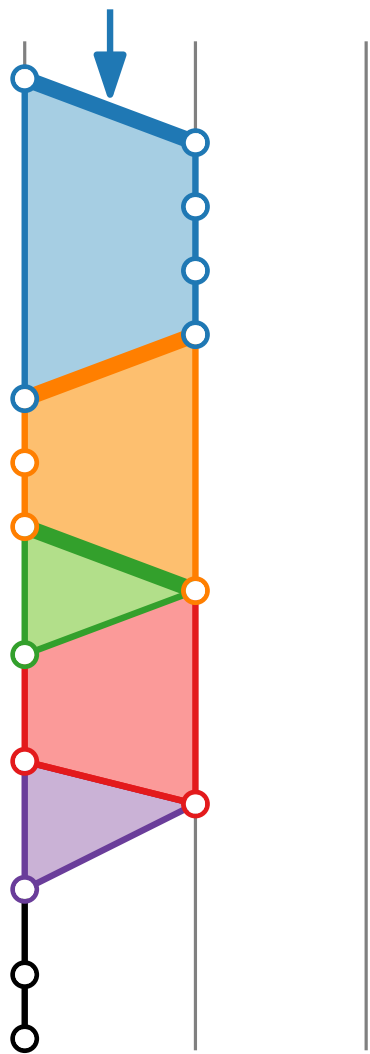

Fixing one diagonal fixes the whole slab
Idea: guess the topmost diagonal

Strong: Biconnected Graphs

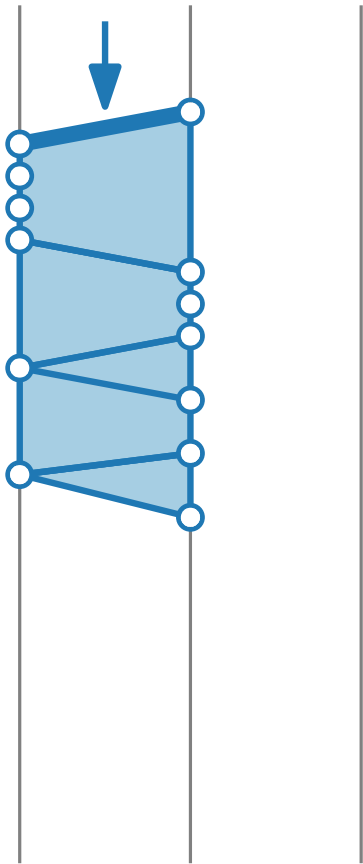

Fixing one diagonal fixes the whole slab
Idea: guess the topmost diagonal

Strong: Biconnected Graphs

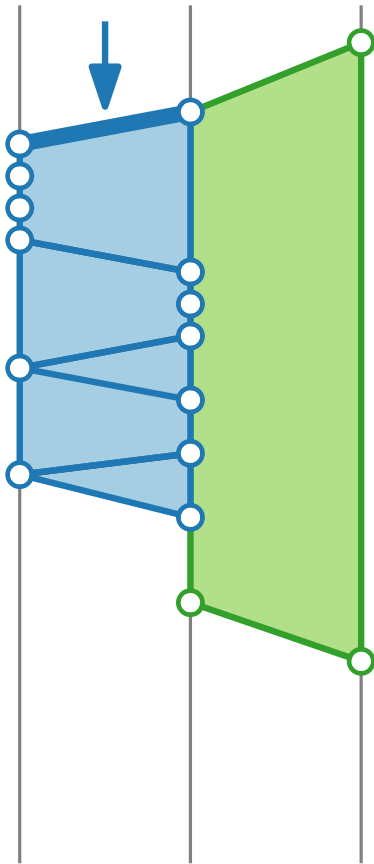

Fixing one diagonal fixes the whole slab
Idea: guess the topmost diagonal

Strong: Biconnected Graphs

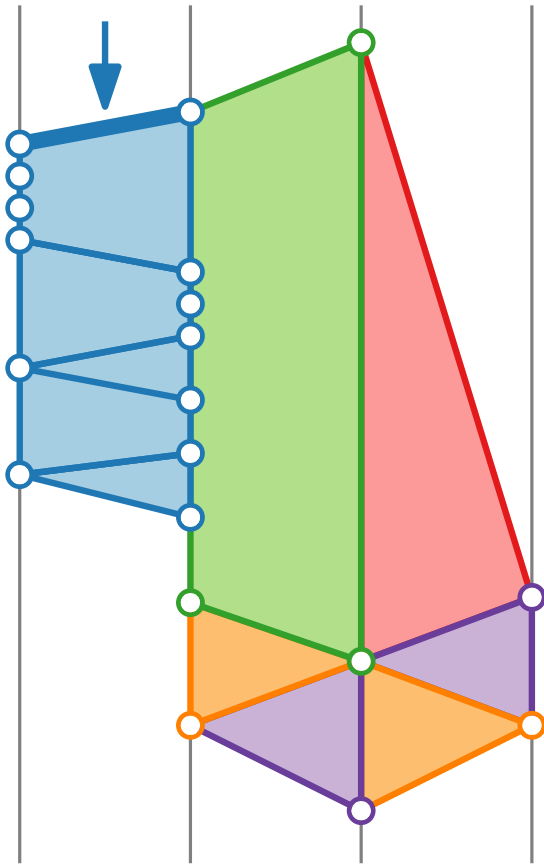

Fixing one diagonal fixes the whole slab
Idea: guess the topmost diagonal

Strong: Biconnected Graphs

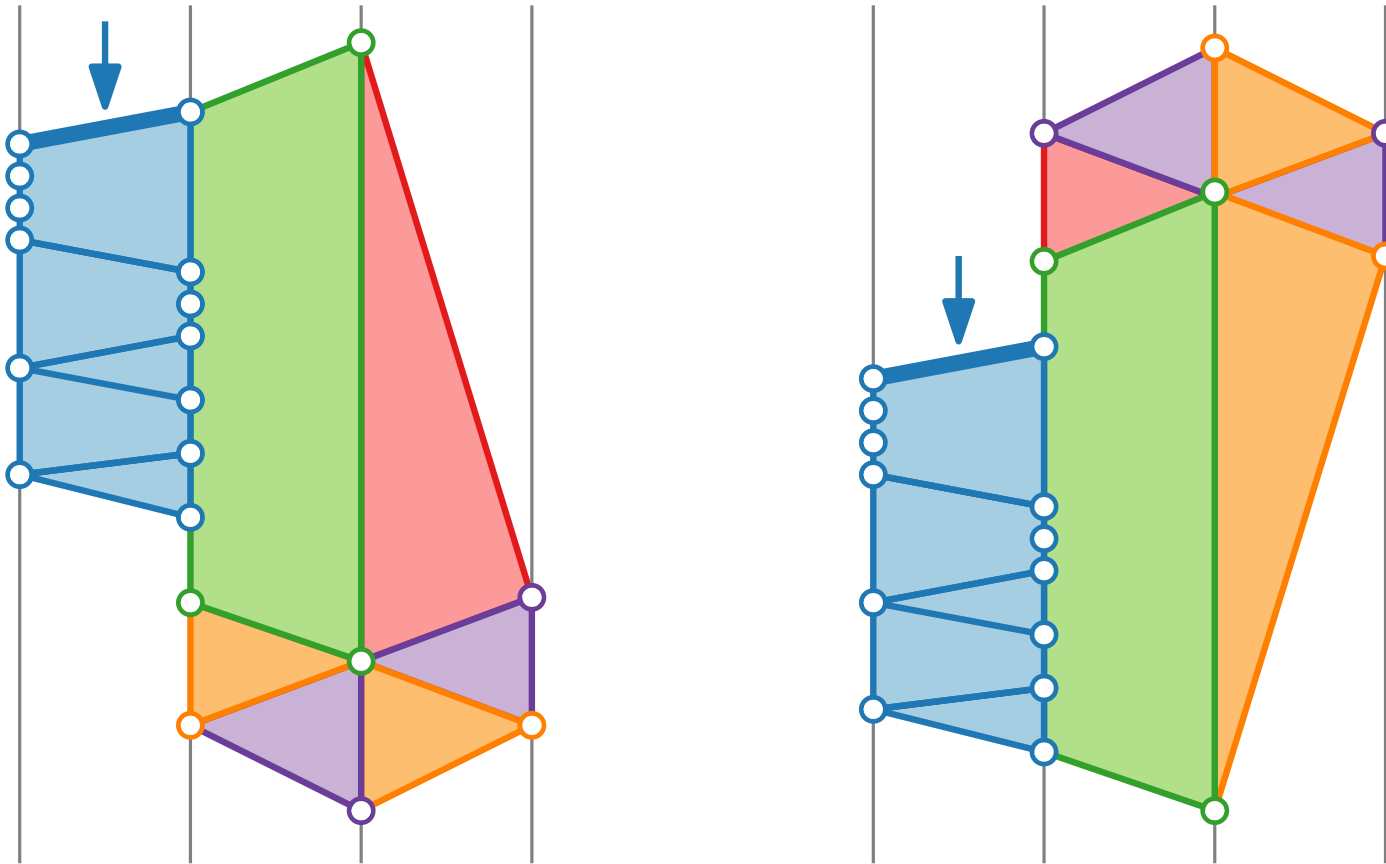

Fixing one diagonal fixes the whole slab
Idea: guess the topmost diagonal

Strong: Biconnected Graphs

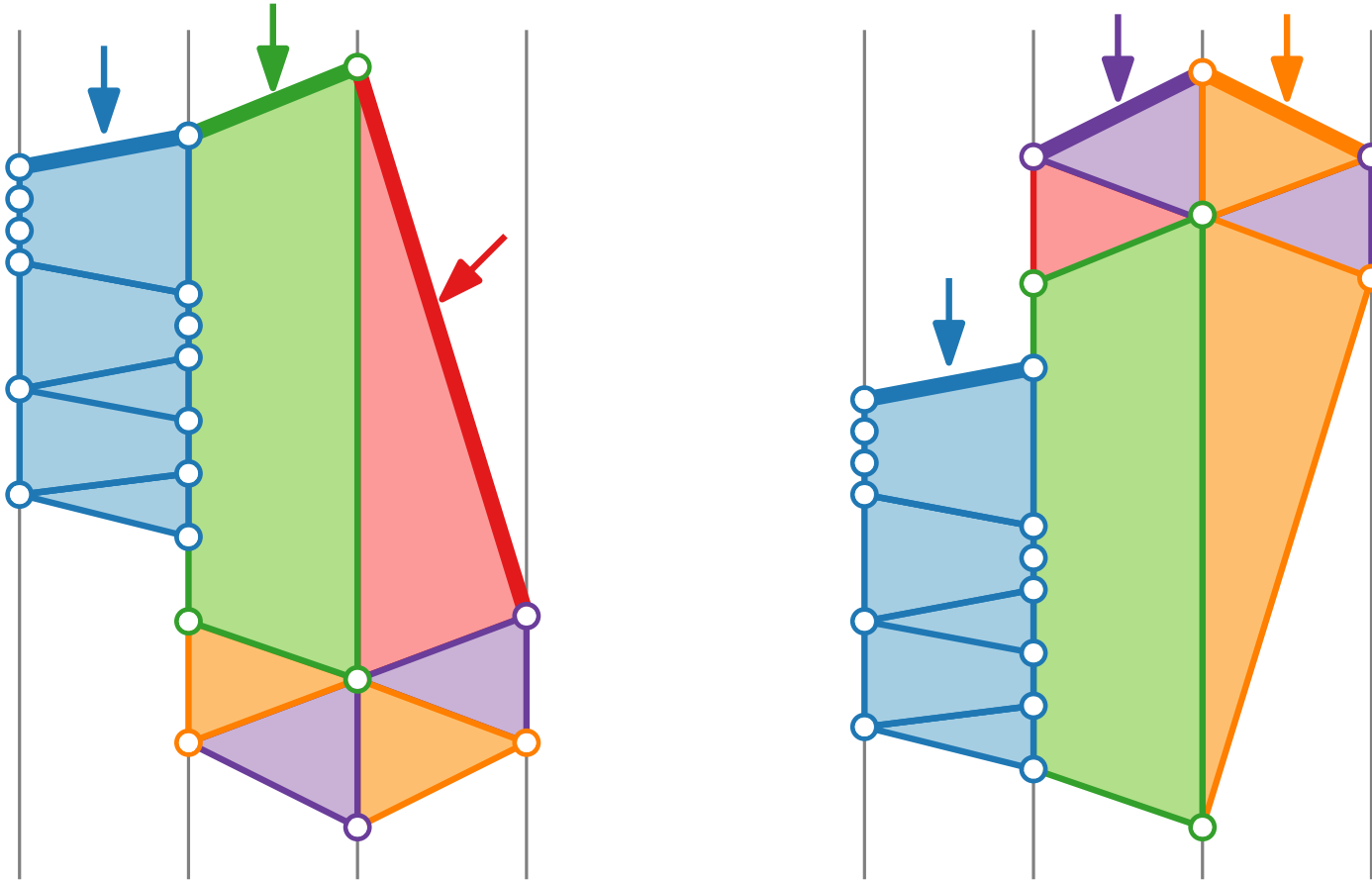

Fixing one diagonal fixes the whole slab
Idea: guess the topmost diagonal

Strong: Biconnected Graphs

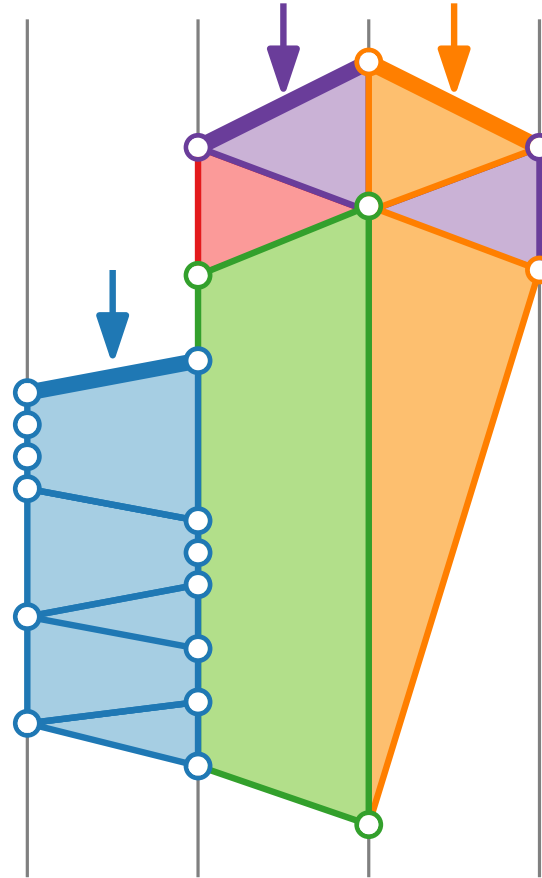
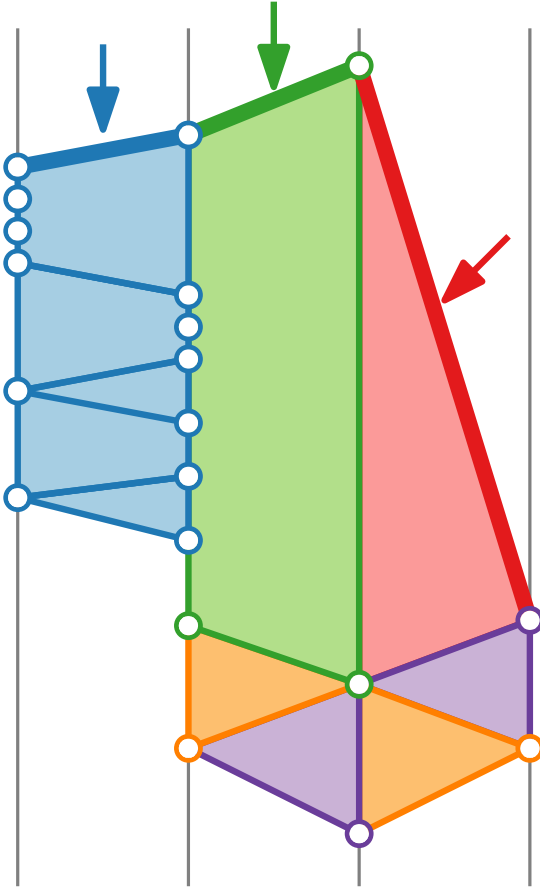

Strong: Biconnected Graphs

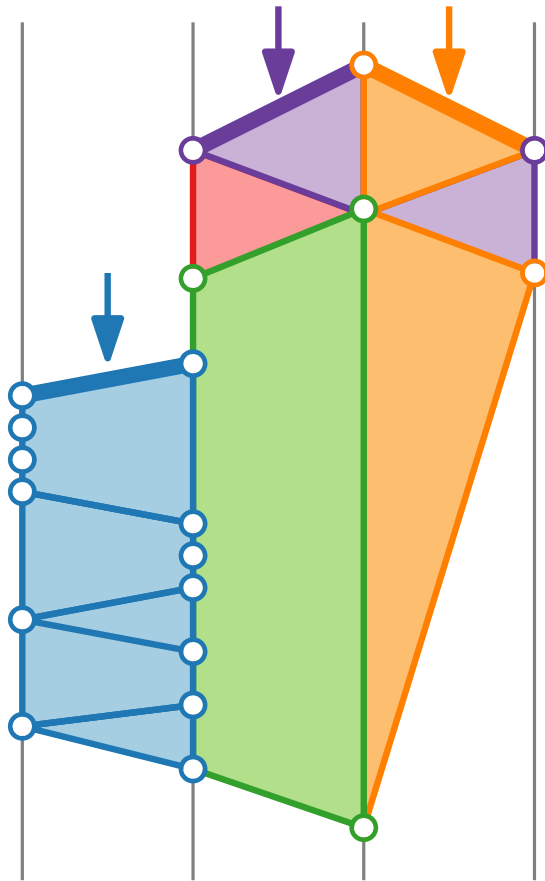
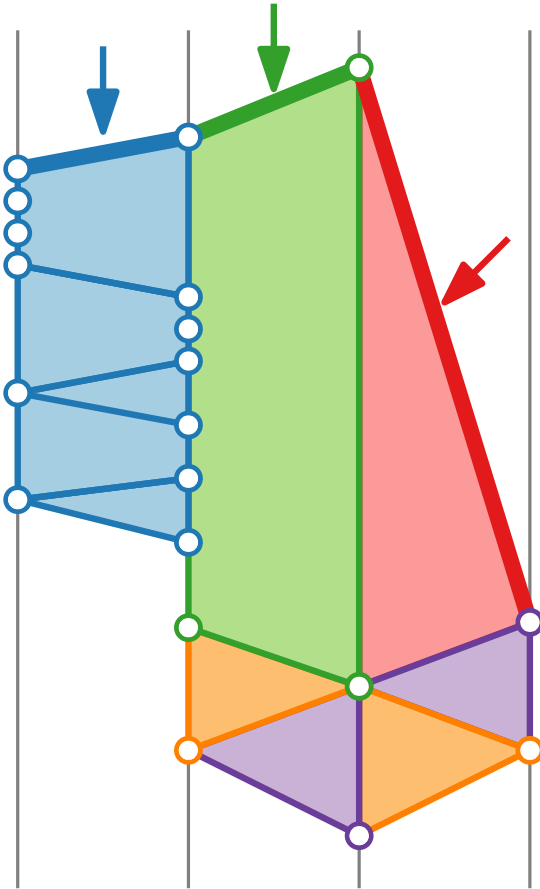

Strong: Biconnected Graphs

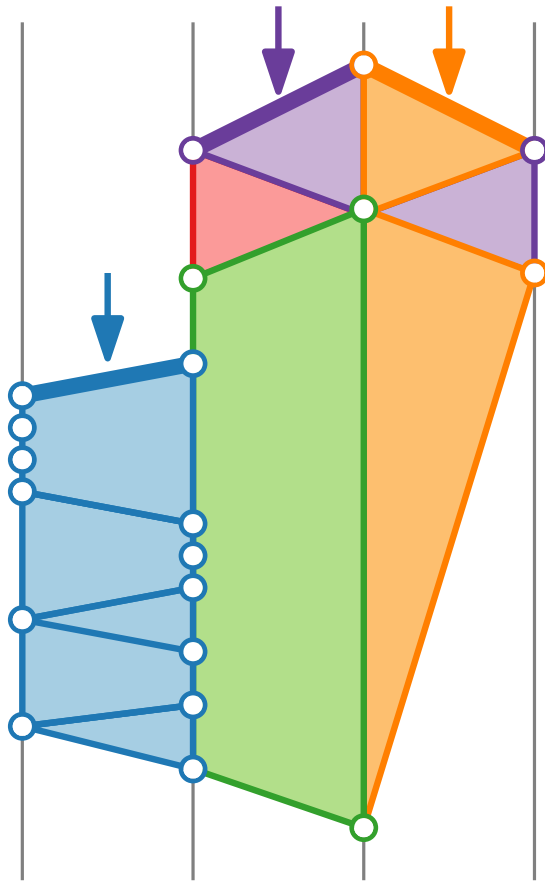
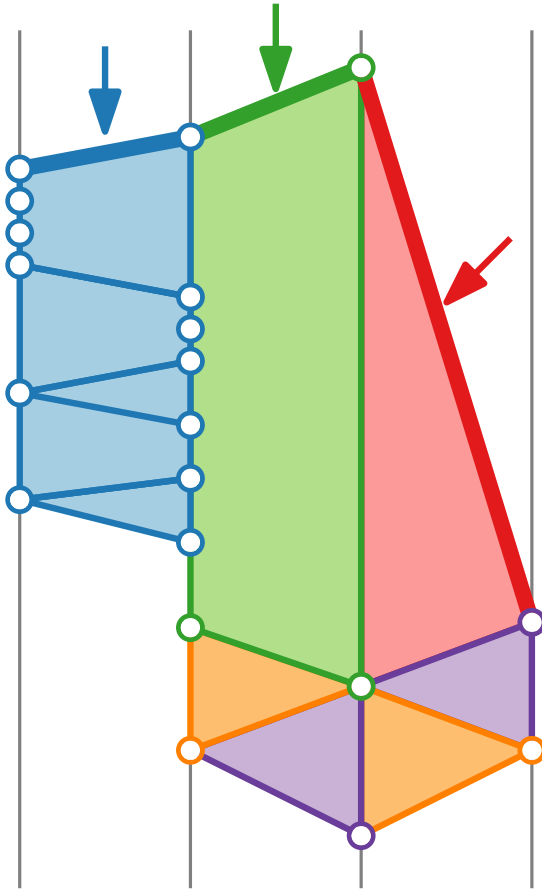

Strong: Biconnected Graphs

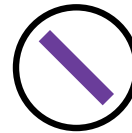
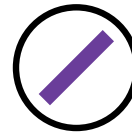
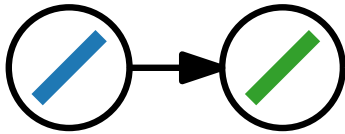
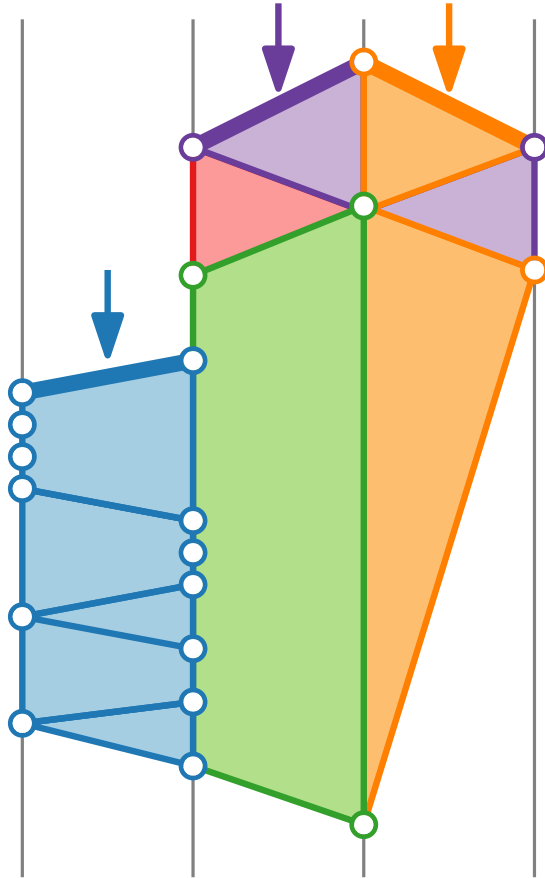
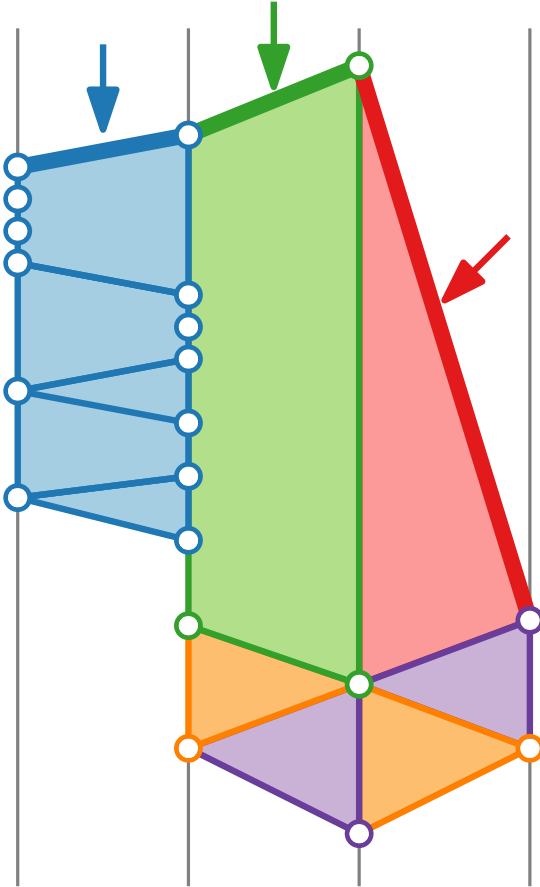

Strong: Biconnected Graphs

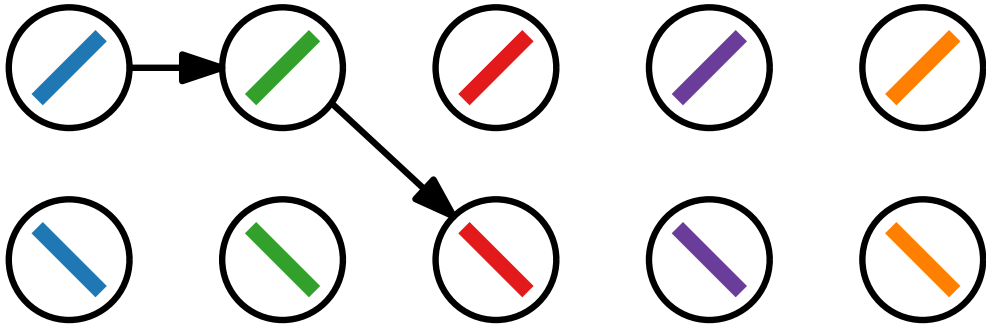
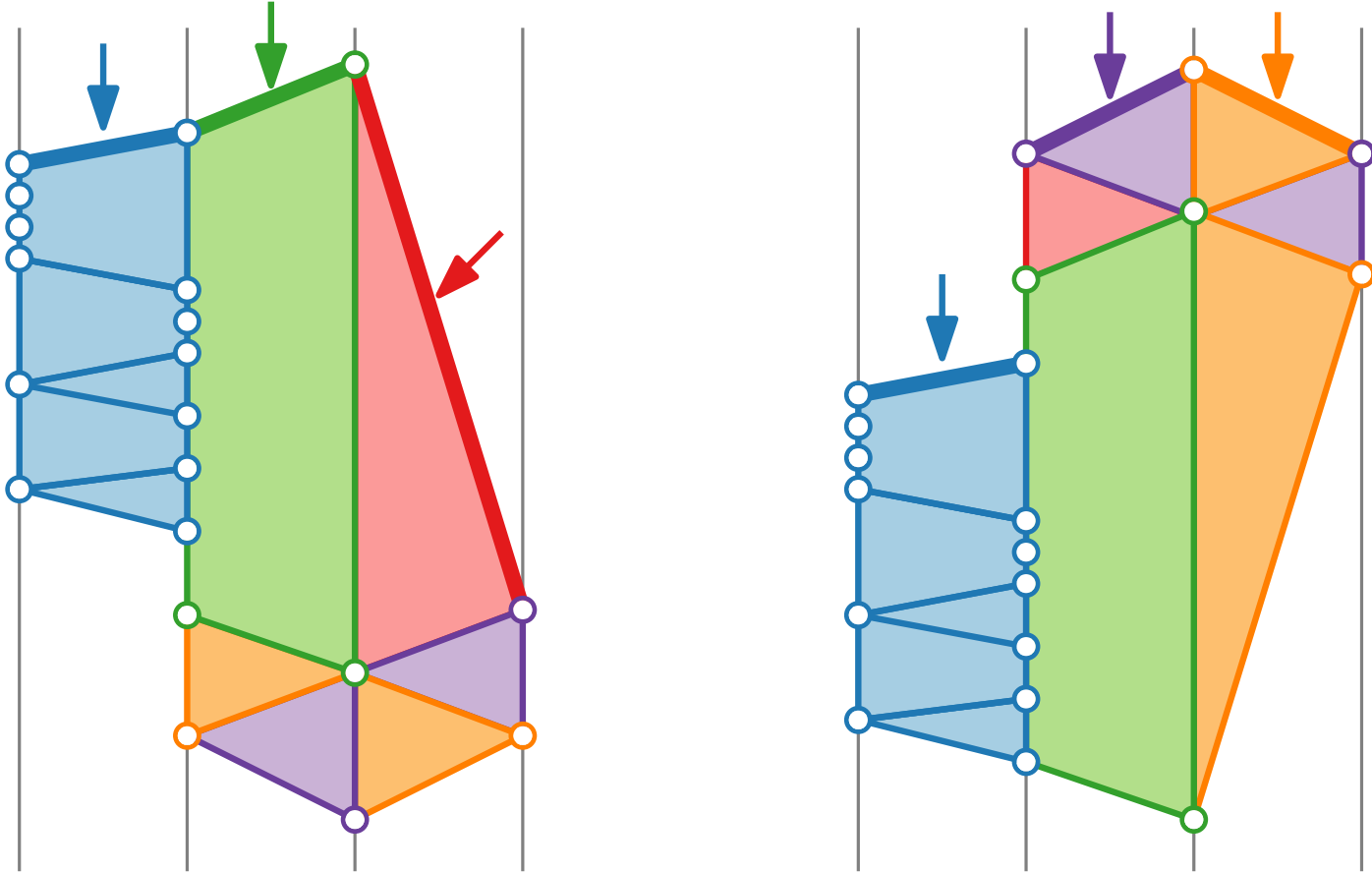

Strong: Biconnected Graphs

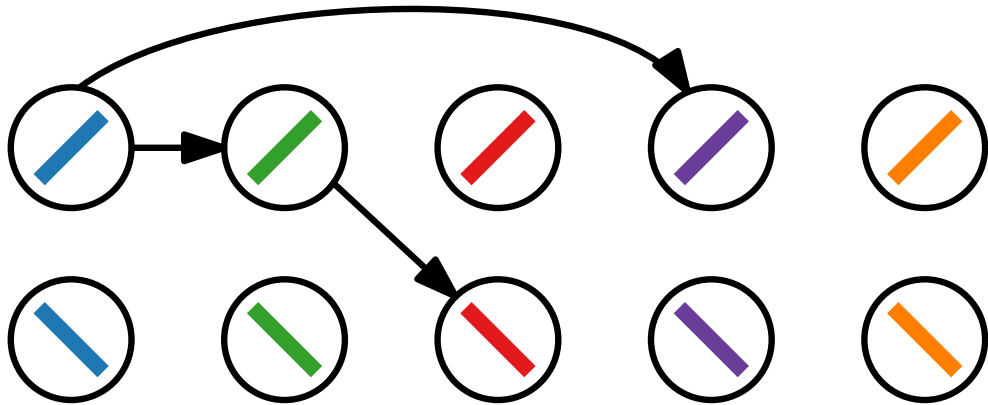
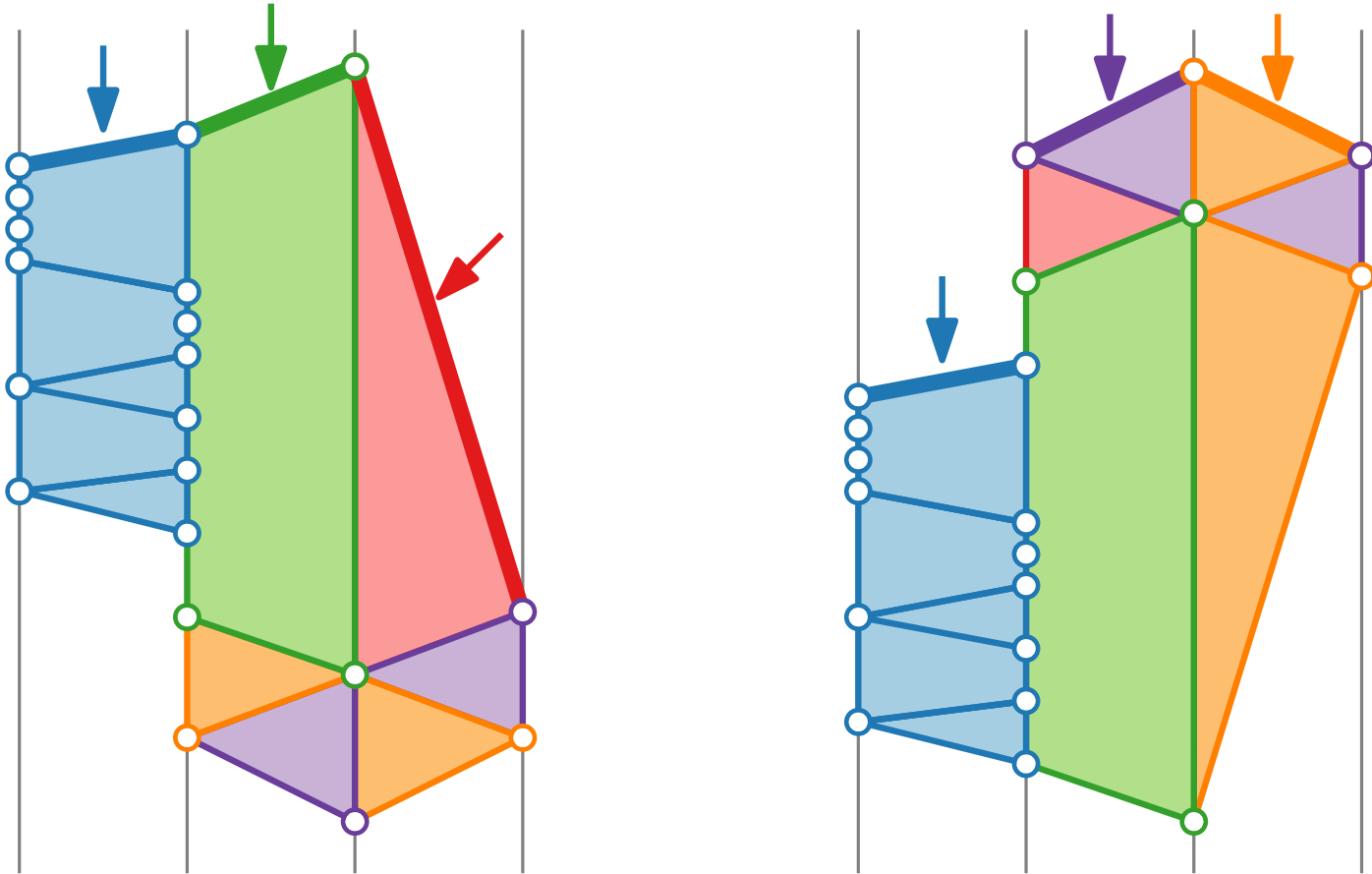

Strong: Biconnected Graphs

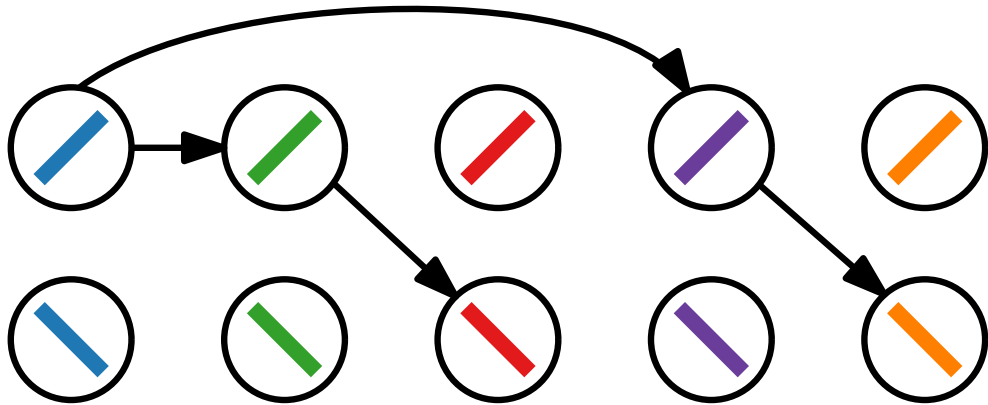
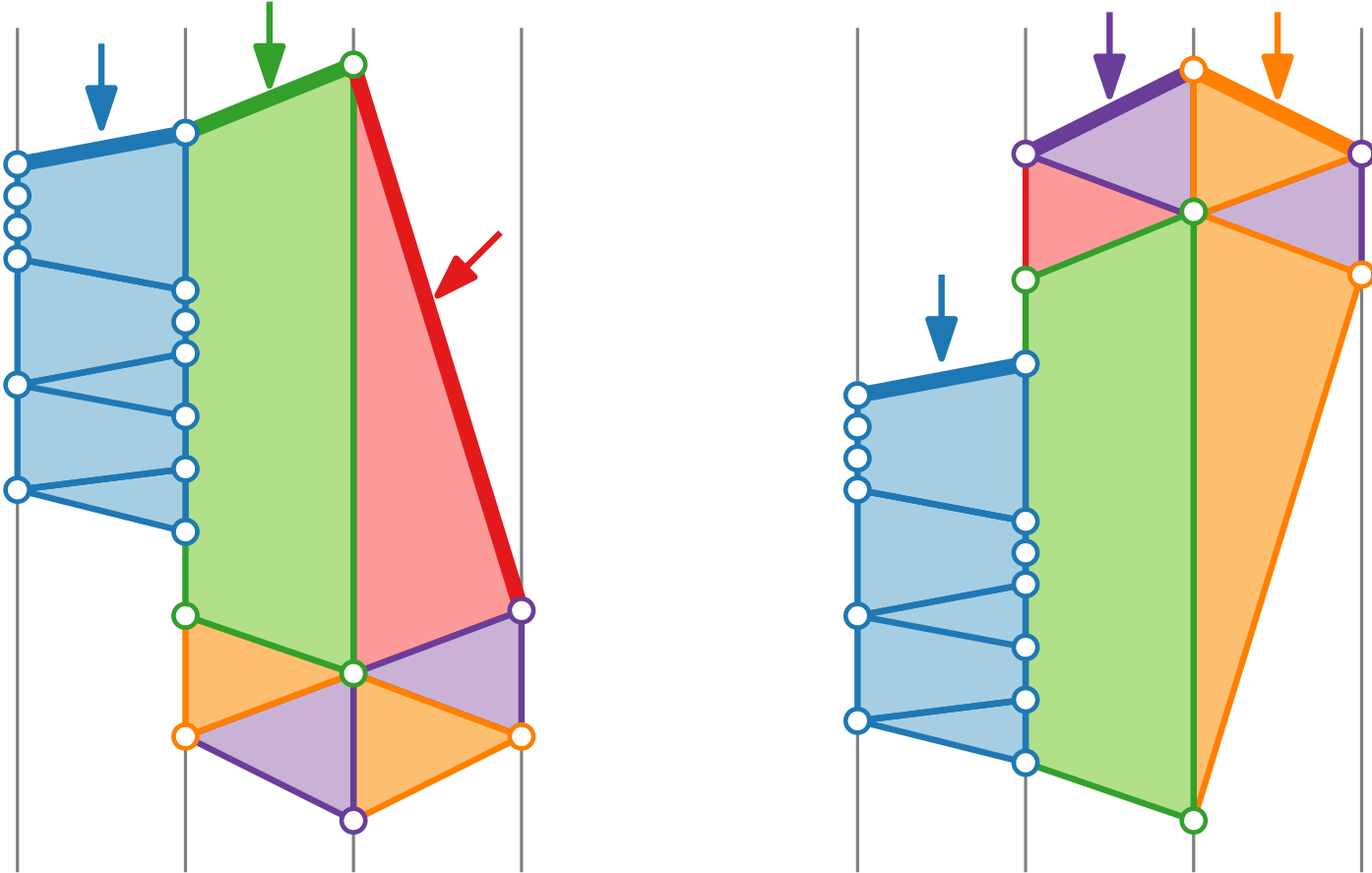

Strong: Biconnected Graphs

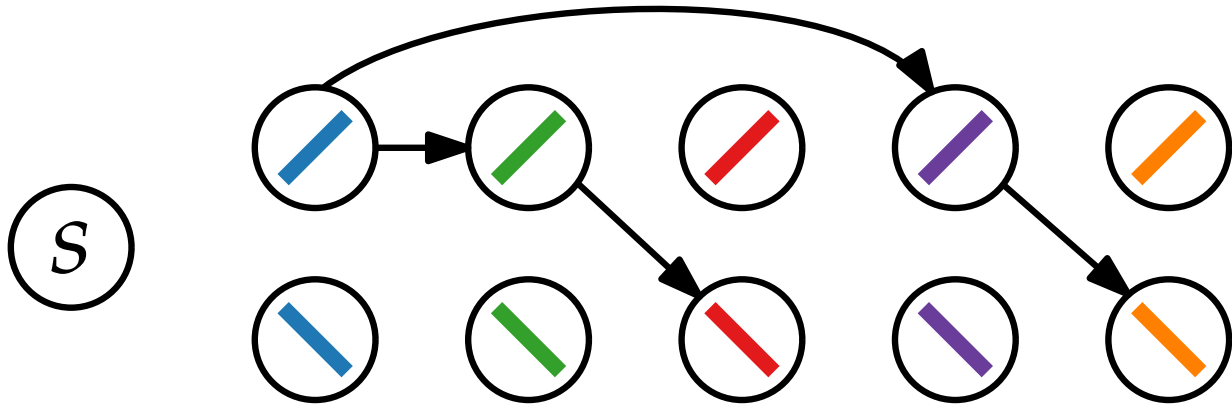
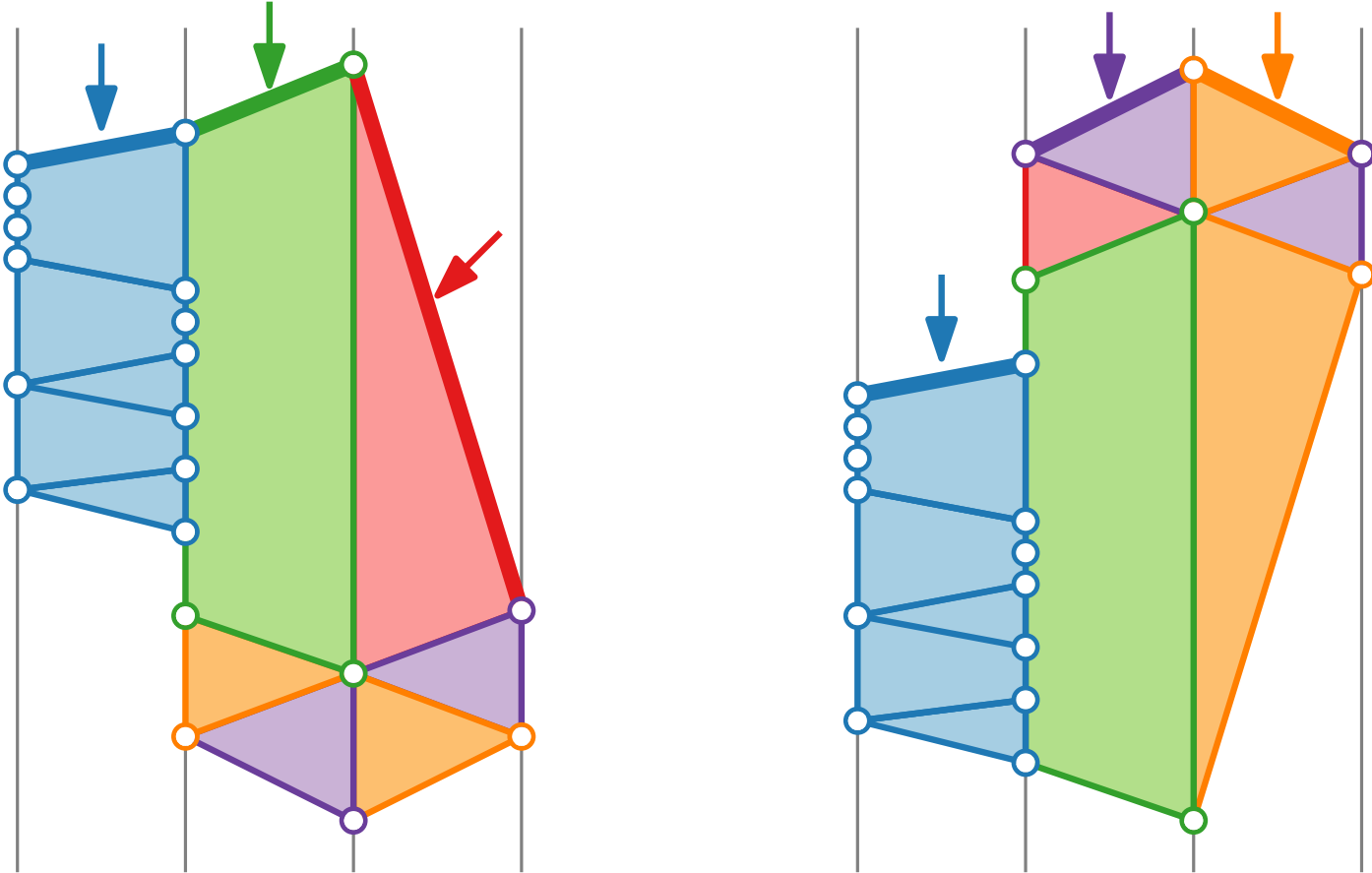

Strong: Biconnected Graphs

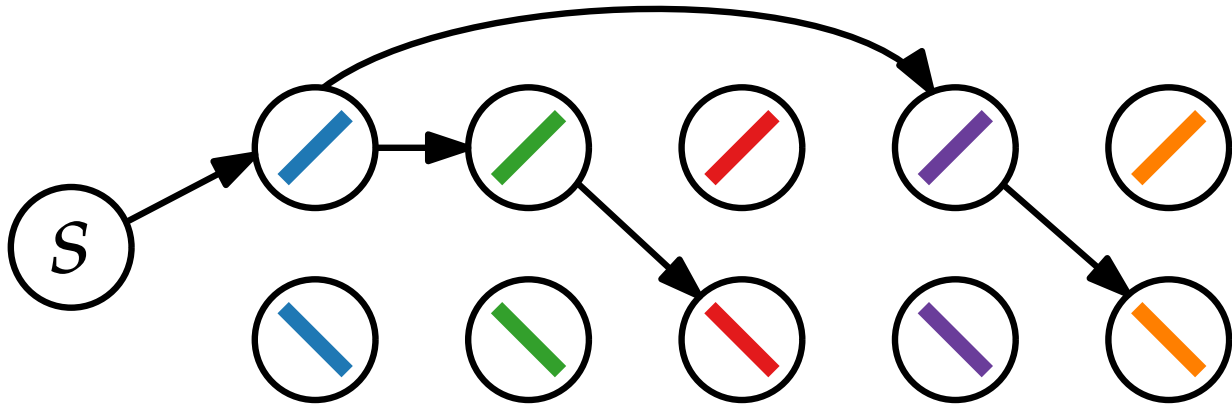
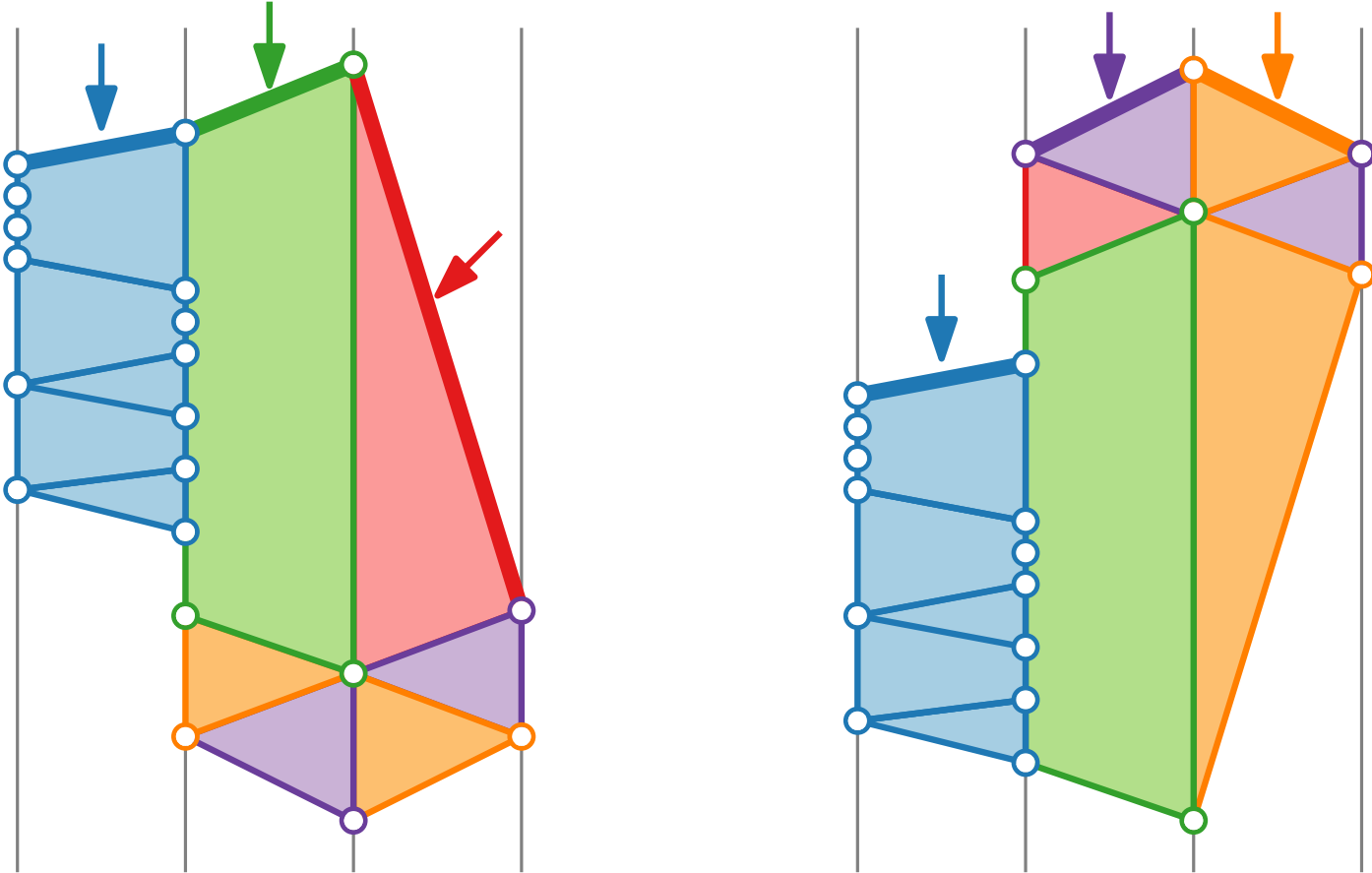

Strong: Biconnected Graphs

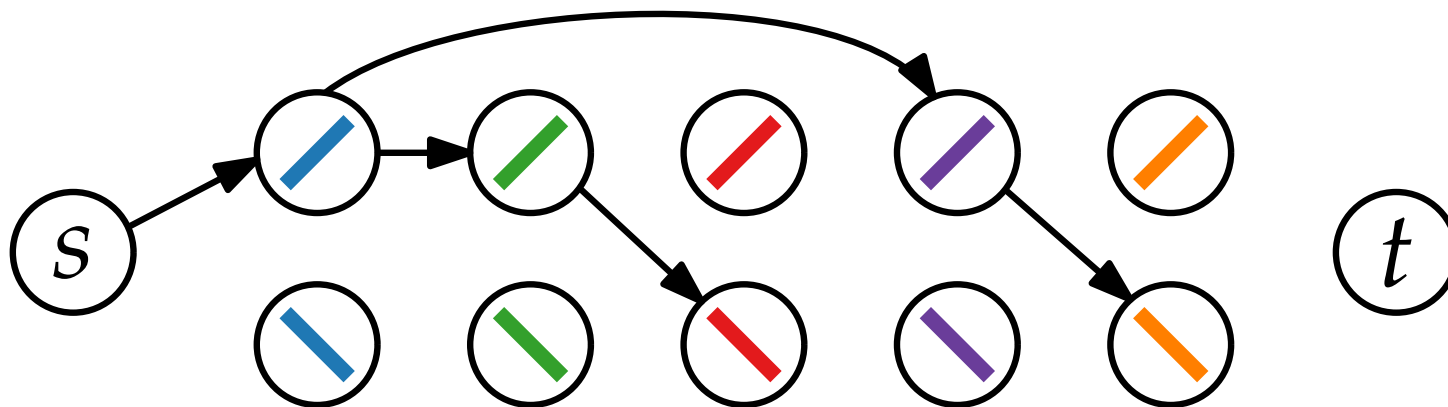
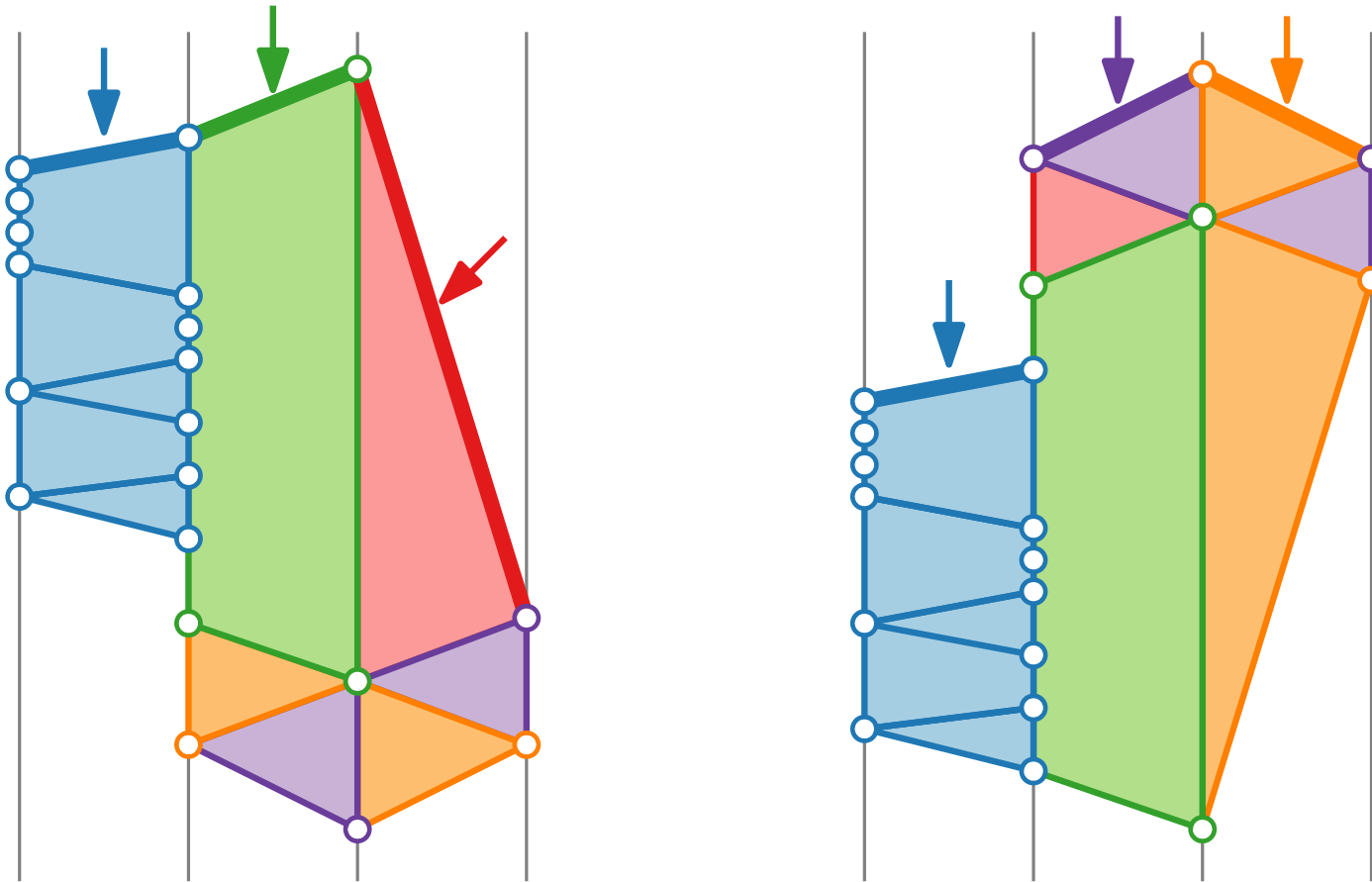

Strong: Biconnected Graphs

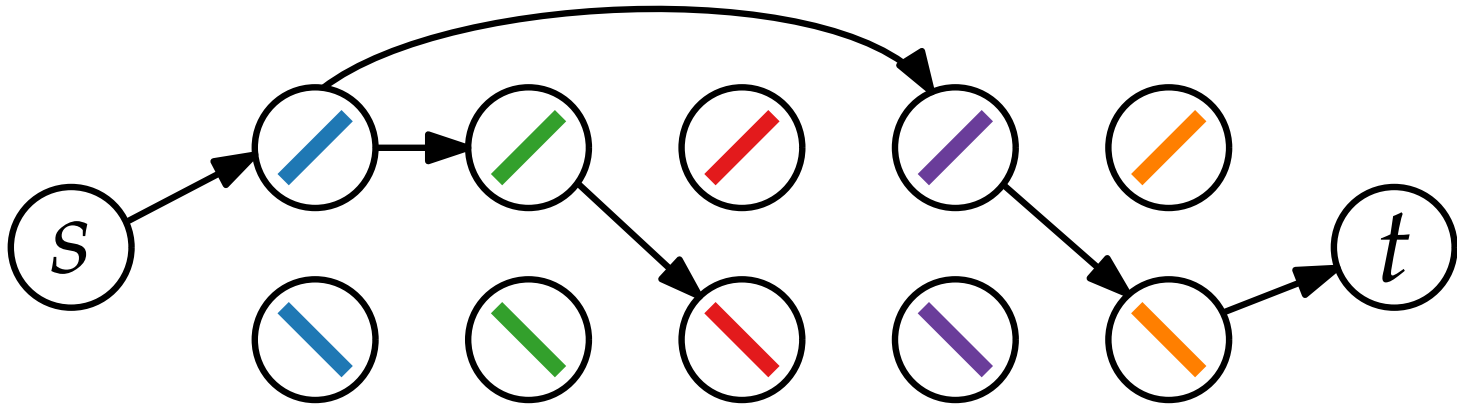
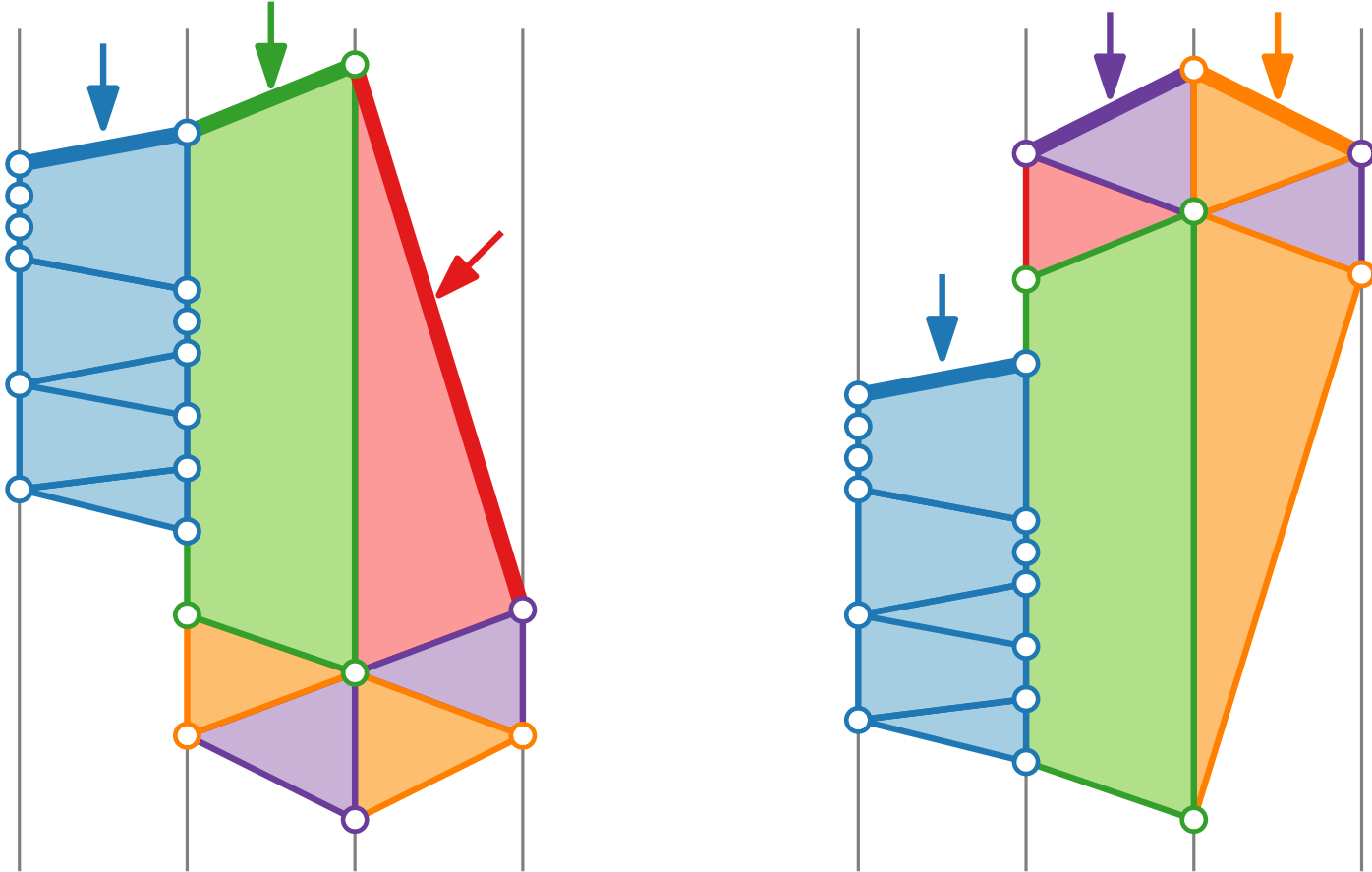

Strong: Biconnected Graphs

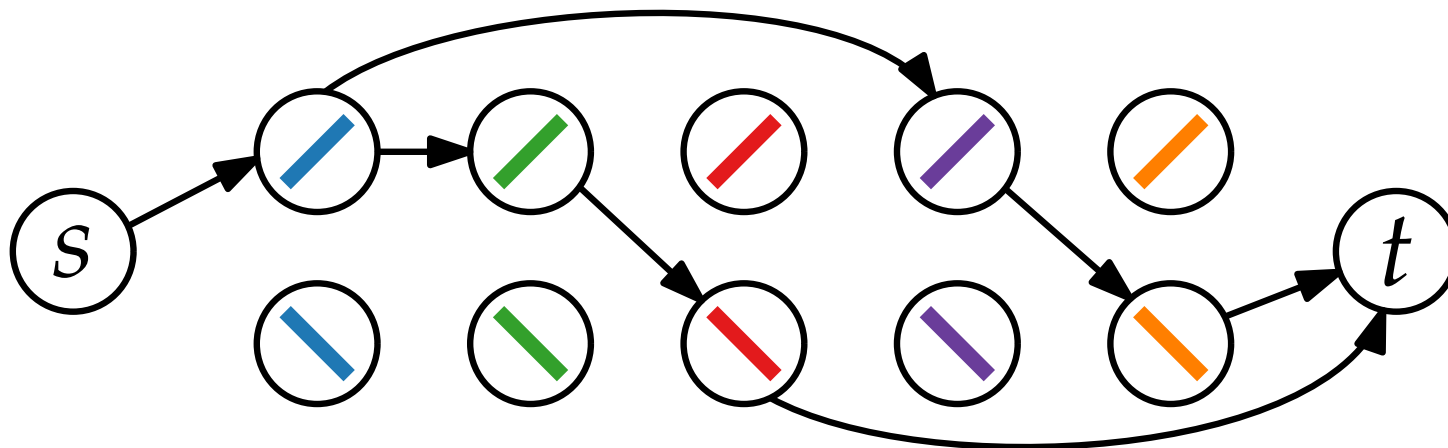
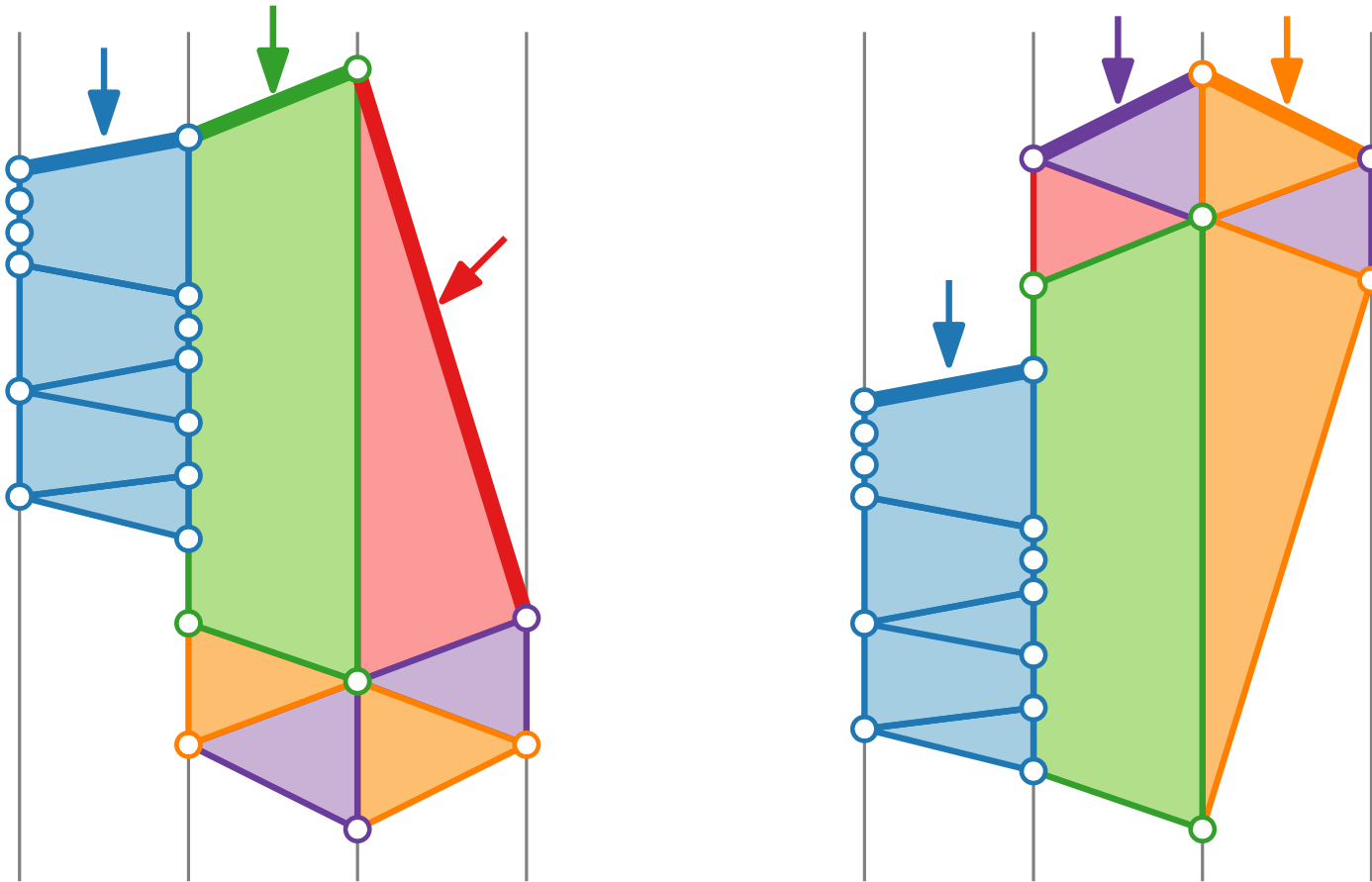

Strong: Biconnected Graphs

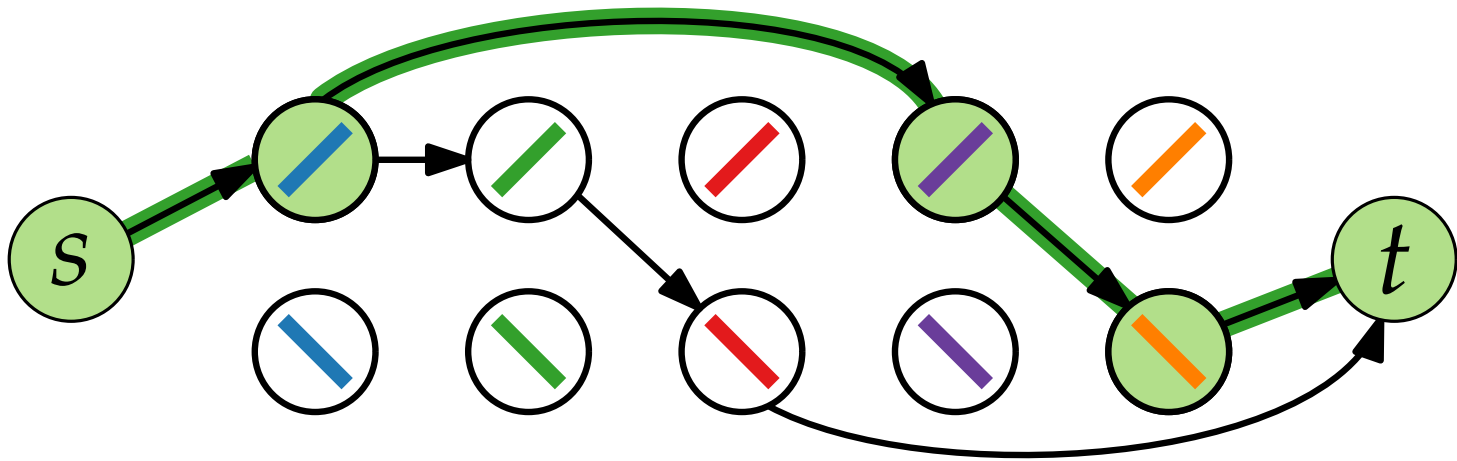
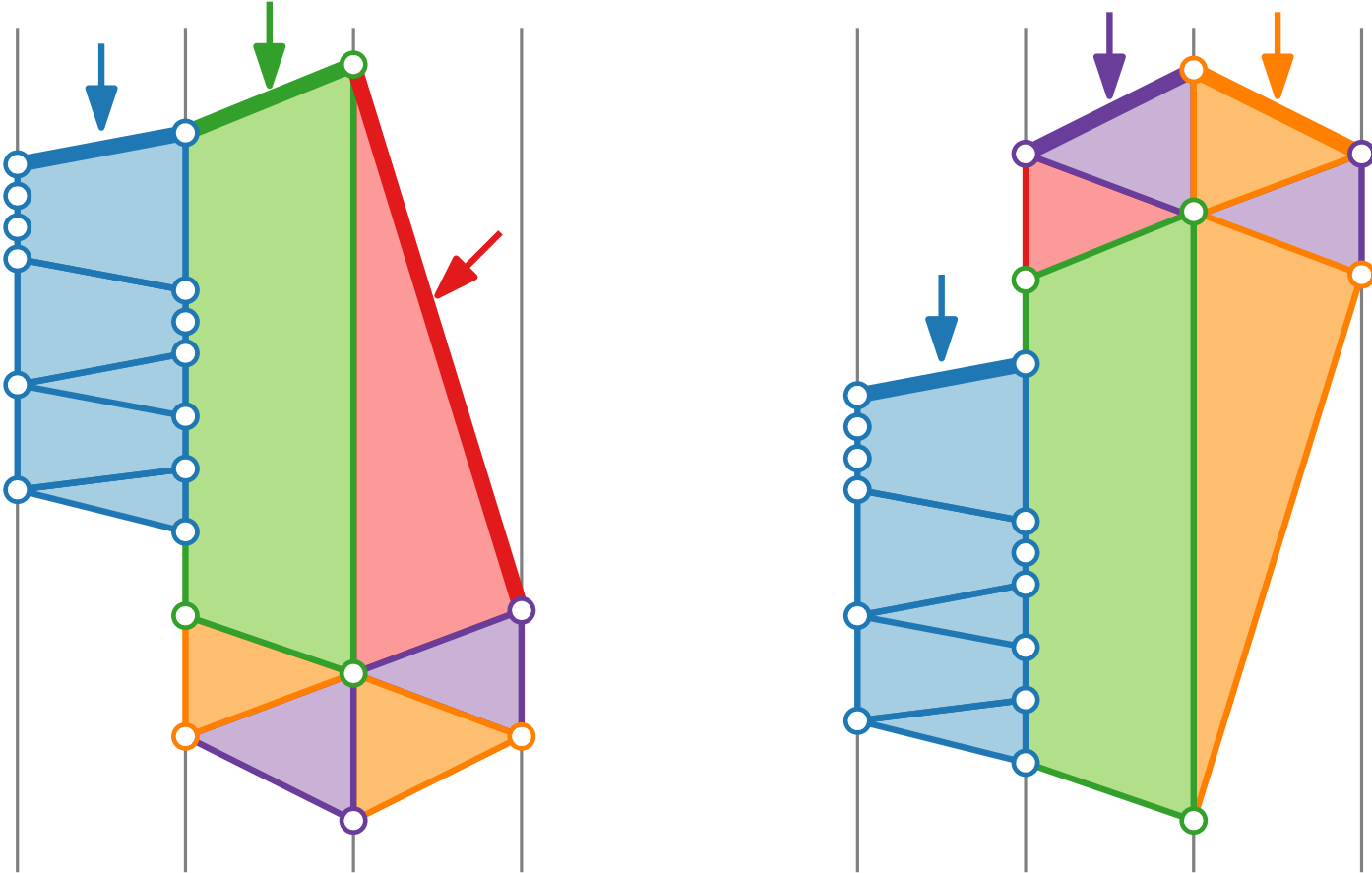

Strong: Biconnected Graphs

Biconnected Graph
⇒ Test + draw in $O(n^3)$ time

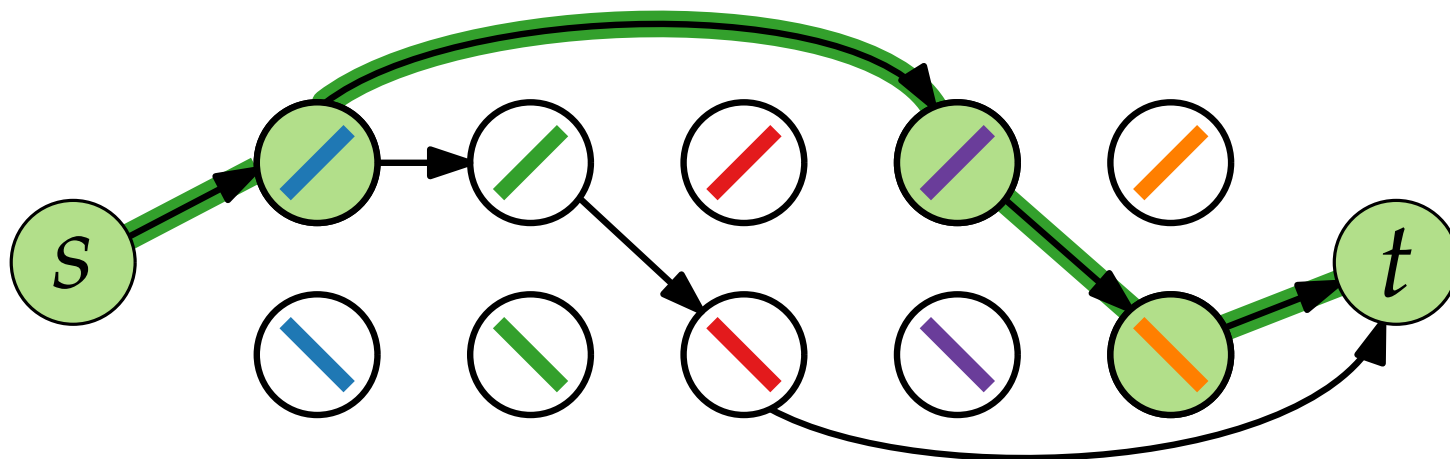
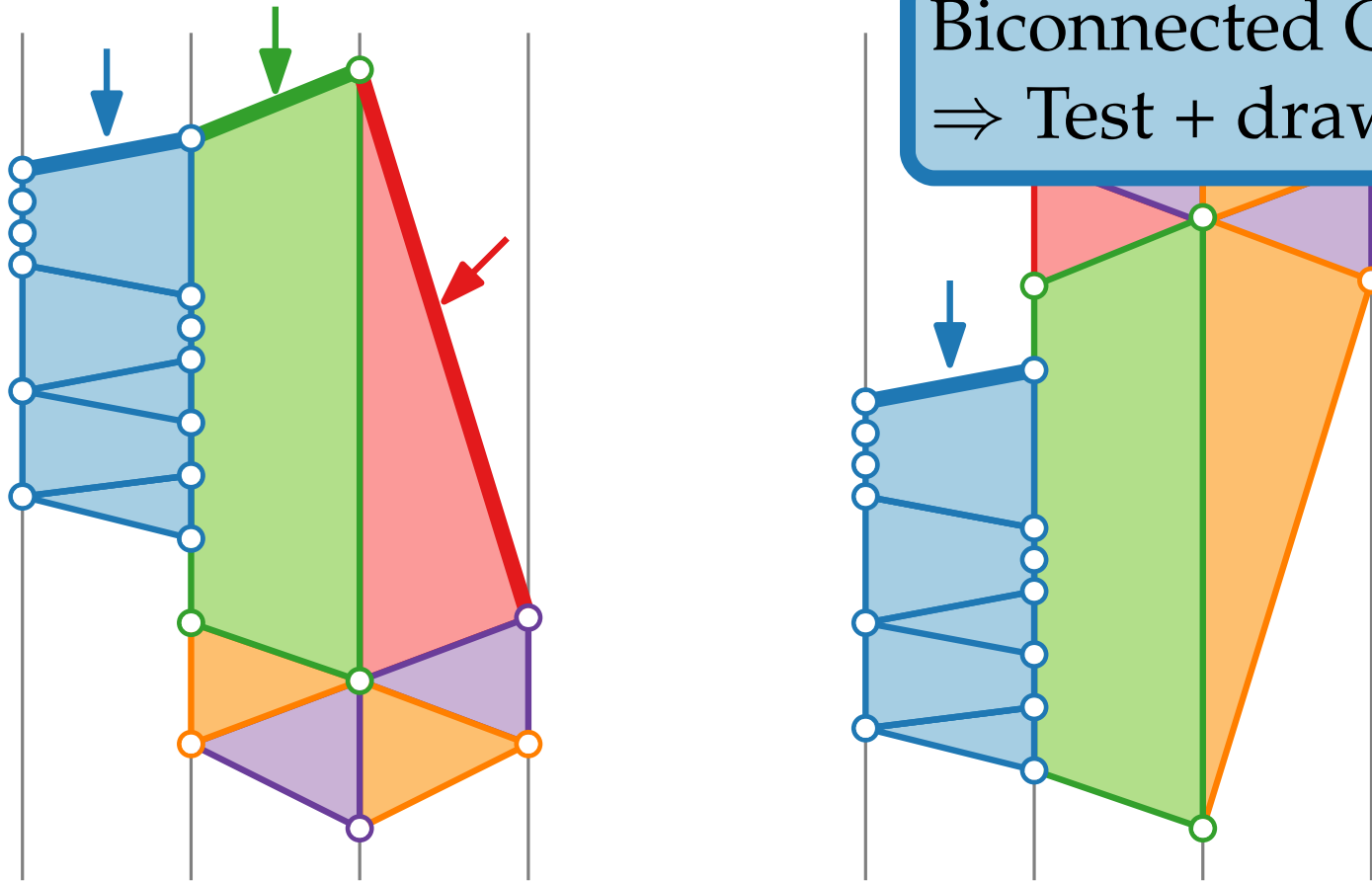

Strong: Biconnected Graphs

Biconnected Graph
⇒ Test + draw in $O(n^{\cancel{3}2})$ time

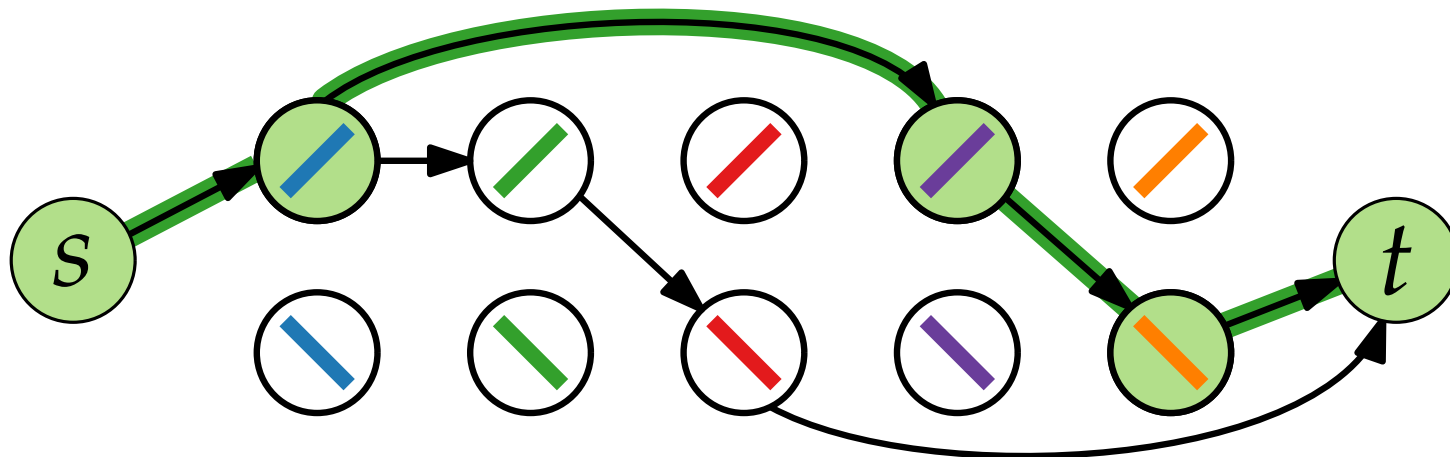
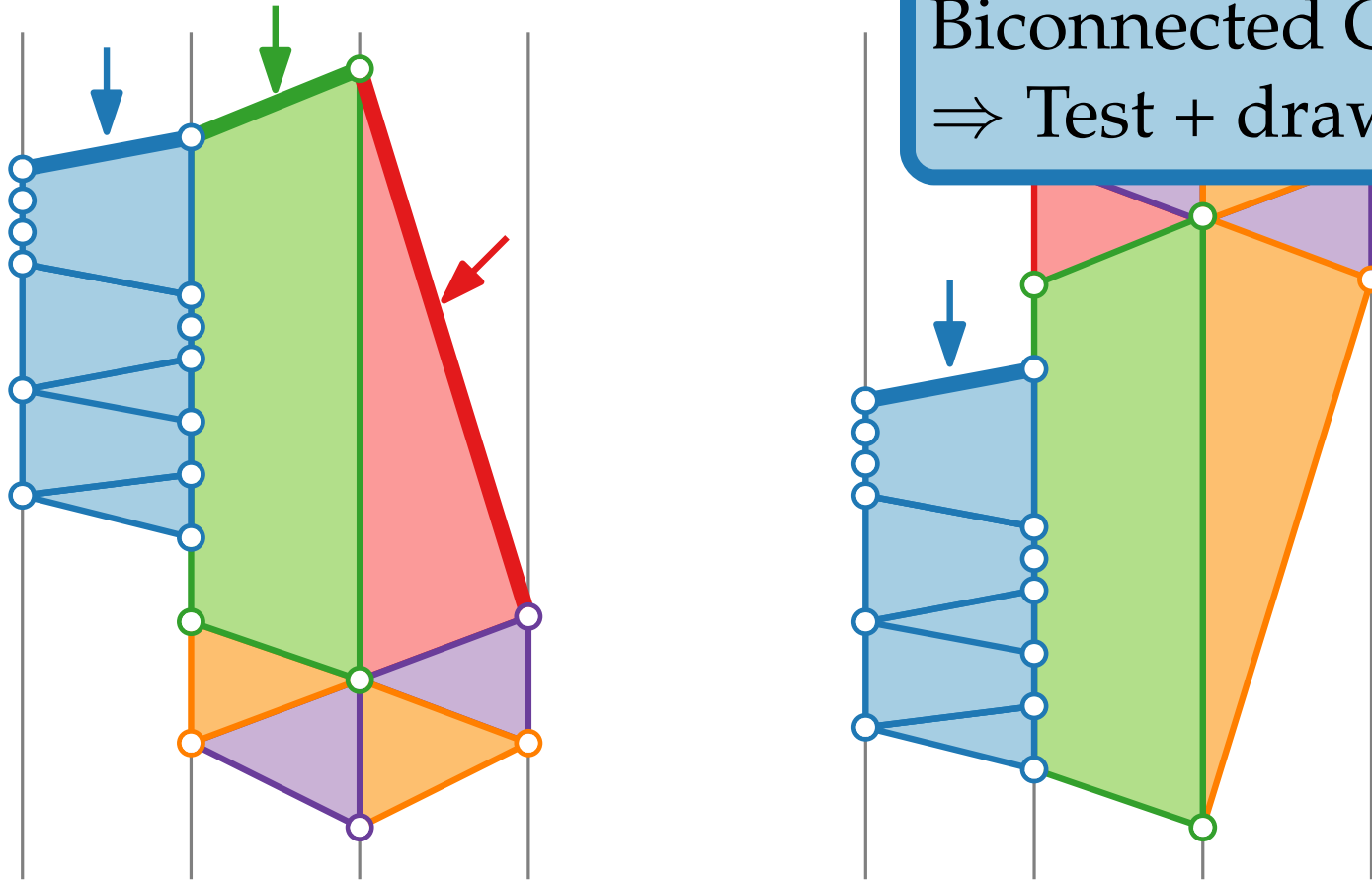

Strong: ~~Biconnected~~ Graphs

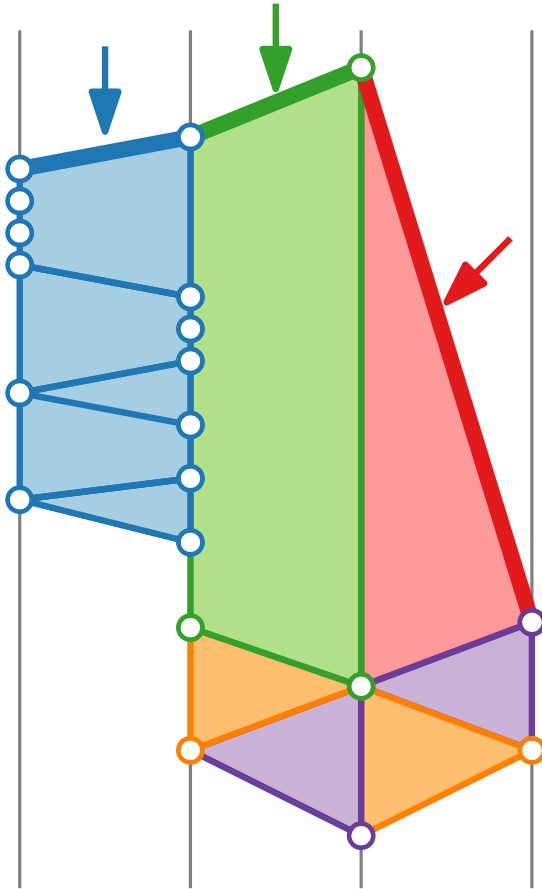

~~Biconnected~~ Graph
⇒ Test + draw in $O(n^{\cancel{3}2})$ time

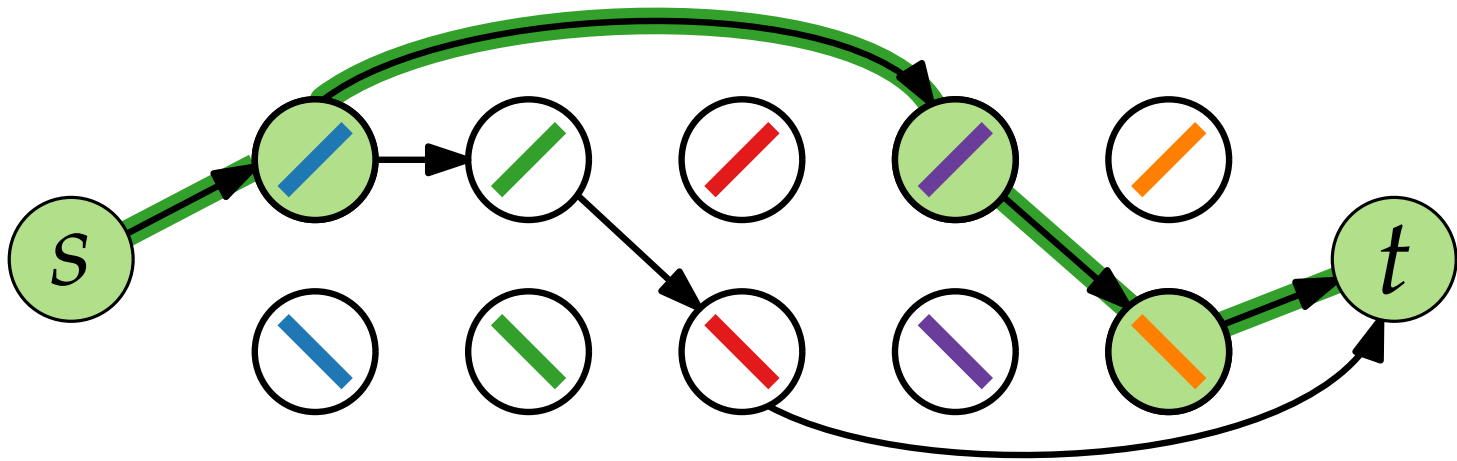
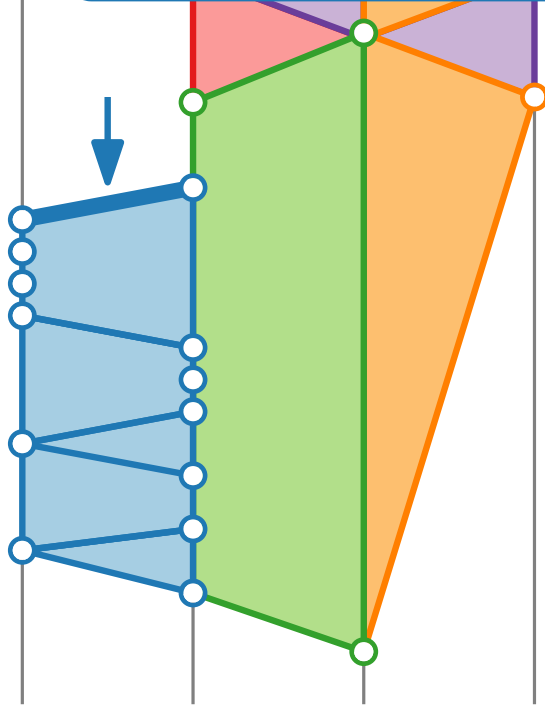

Summary

Weak

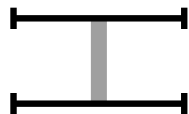
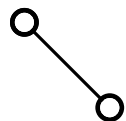

Strong

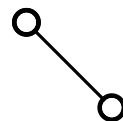

Summary

Weak

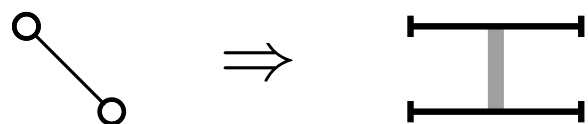

~~X~~ Trees, maxdeg 5



Strong

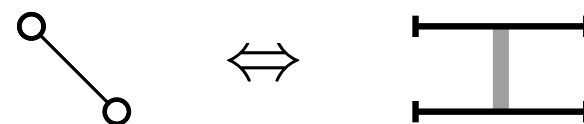

Summary

Weak

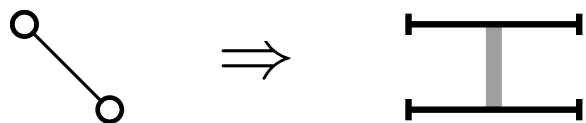

X Trees, maxdeg 5



✓ Trees, maxdeg 4

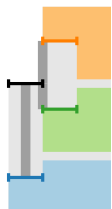

Strong

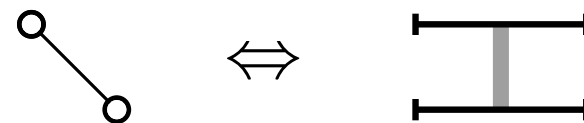

Summary

Weak

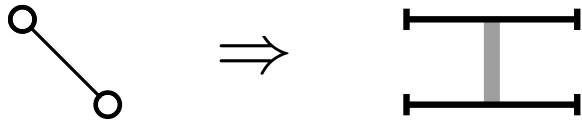

Strong

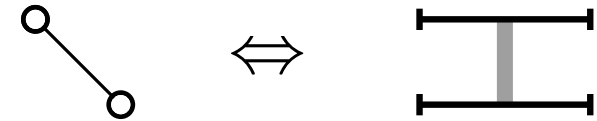

X Trees, maxdeg 5

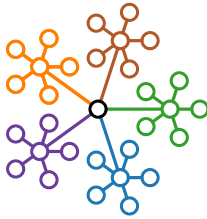

✓ Trees, maxdeg 4



✓ Biconn. outerplanar, maxdeg 4

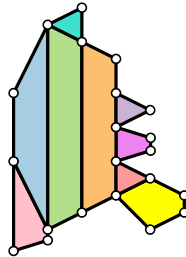

Summary

Weak

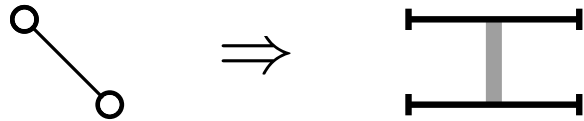

Strong

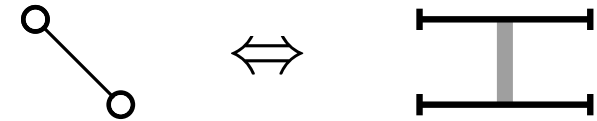

X Trees, maxdeg 5



✓ Trees, maxdeg 4

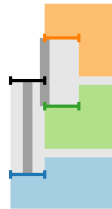

✓ Biconn. outerplanar, maxdeg 4

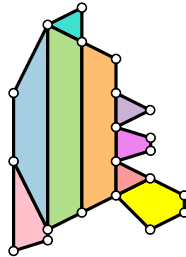

General: NP-hard

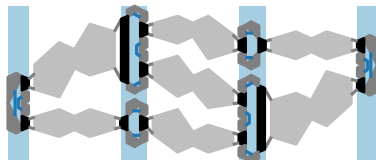

Summary

Weak

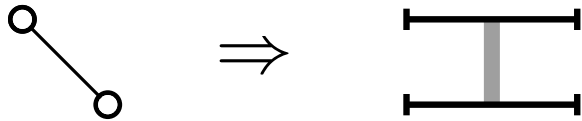

X Trees, maxdeg 5

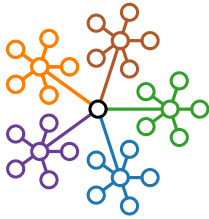

✓ Trees, maxdeg 4



✓ Biconn. outerplanar, maxdeg 4

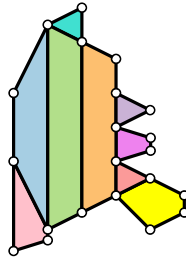

General: NP-hard

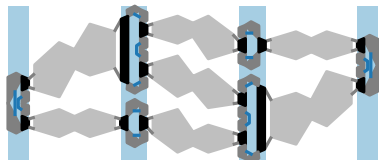

Strong

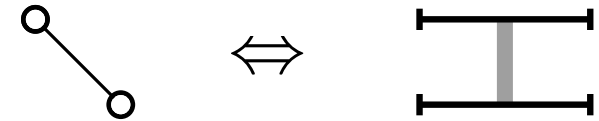

Trees: maxdeg 3,
subdiv. of caterpillar

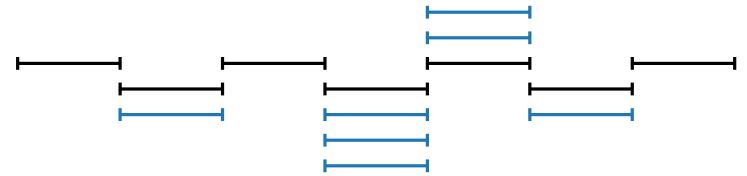

Summary

Weak

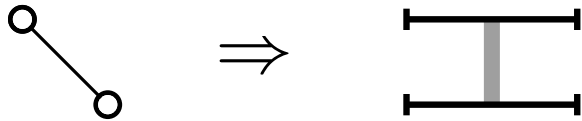

X Trees, maxdeg 5



✓ Trees, maxdeg 4

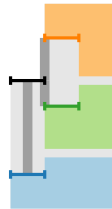

✓ Biconn. outerplanar, maxdeg 4

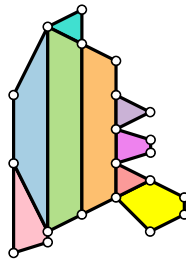

General: NP-hard

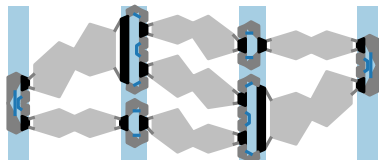

Strong

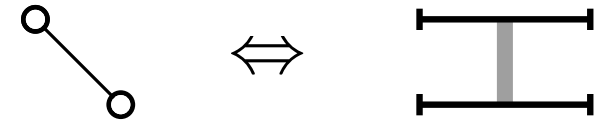

Trees: maxdeg 3, subdiv. of caterpillar

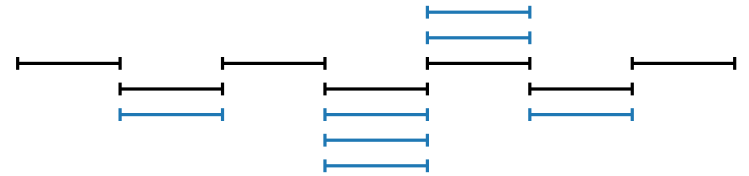

General:
 $O(n^2)$ time recognition

