

Kreuzungen, Kurven und Constraints beim Zeichnen von Graphen

Crossings, Curves, and Constraints
in Graph Drawing

Martin Fink
Lehrstuhl für Informatik I
Universität Würzburg

Warum Graphen zeichnen?



Warum Graphen zeichnen?

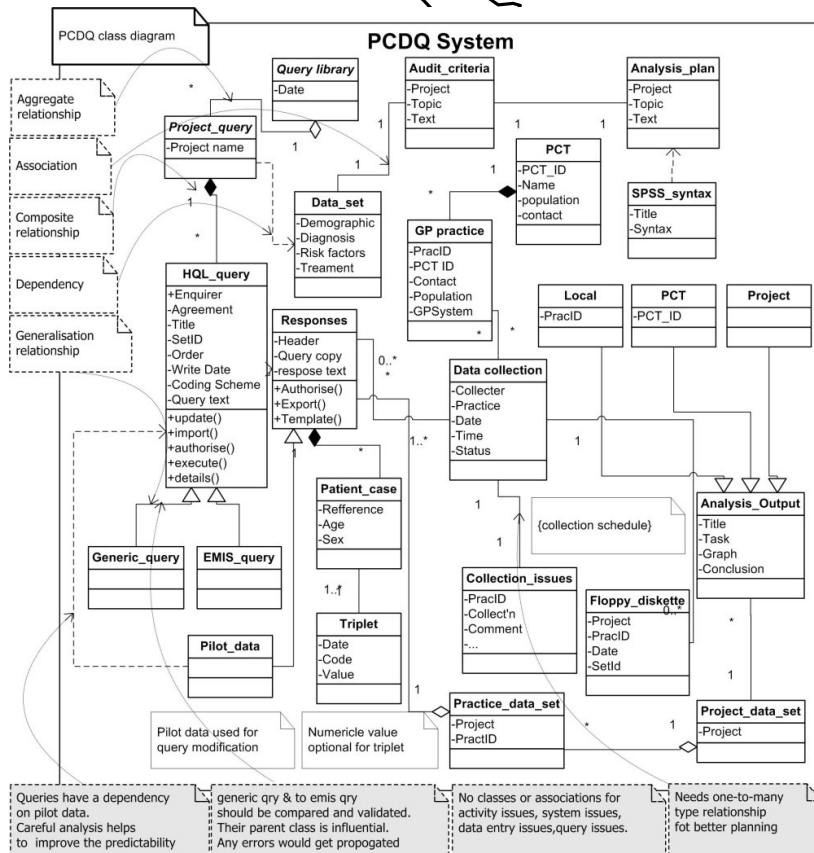
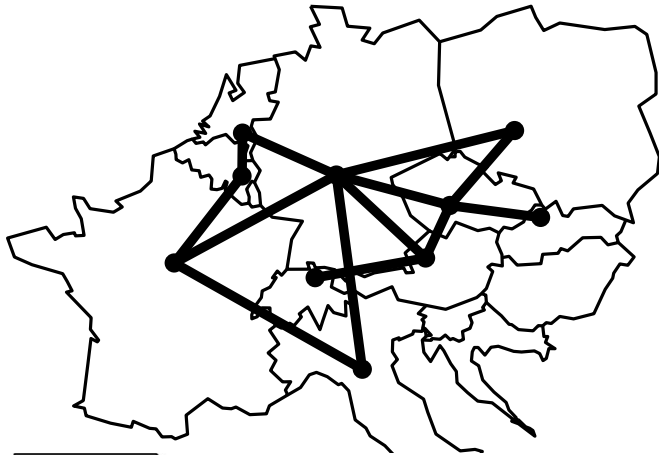

Warum Graphen zeichnen?

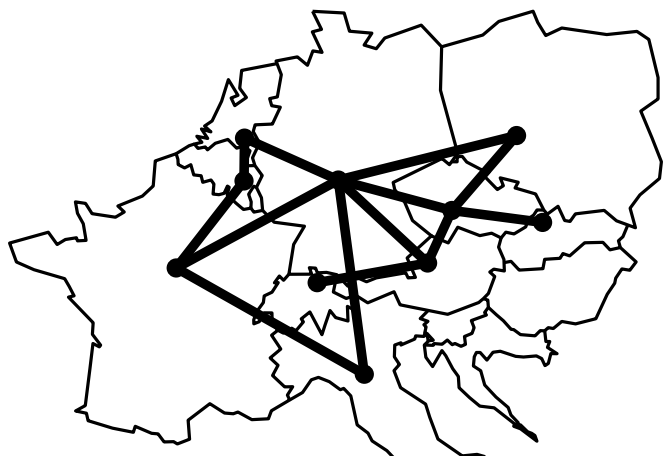

U-Bahn-Netz
Wien
Stand: 2012

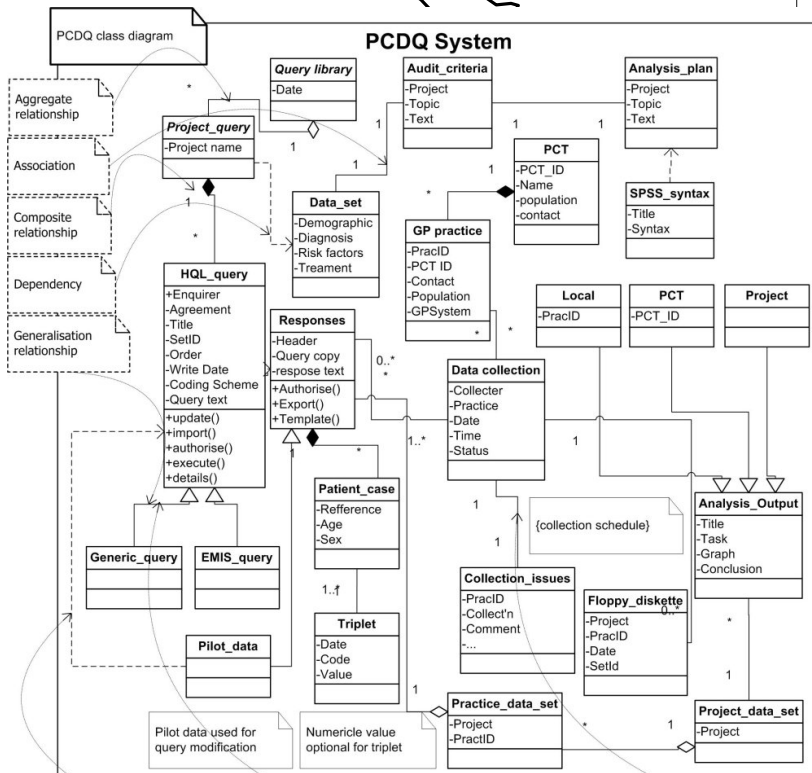

Vieles als Graph modellierbar

Queries have a dependency on pilot data. Careful analysis helps to improve the predictability

generic qry & to emis qry should be compared and validated. Their parent class is influential. Any errors would get propagated

No classes or associations for activity issues, system issues, data entry issues, query issues.

Needs one-to-many type relationship for better planning

Warum Graphen zeichnen?

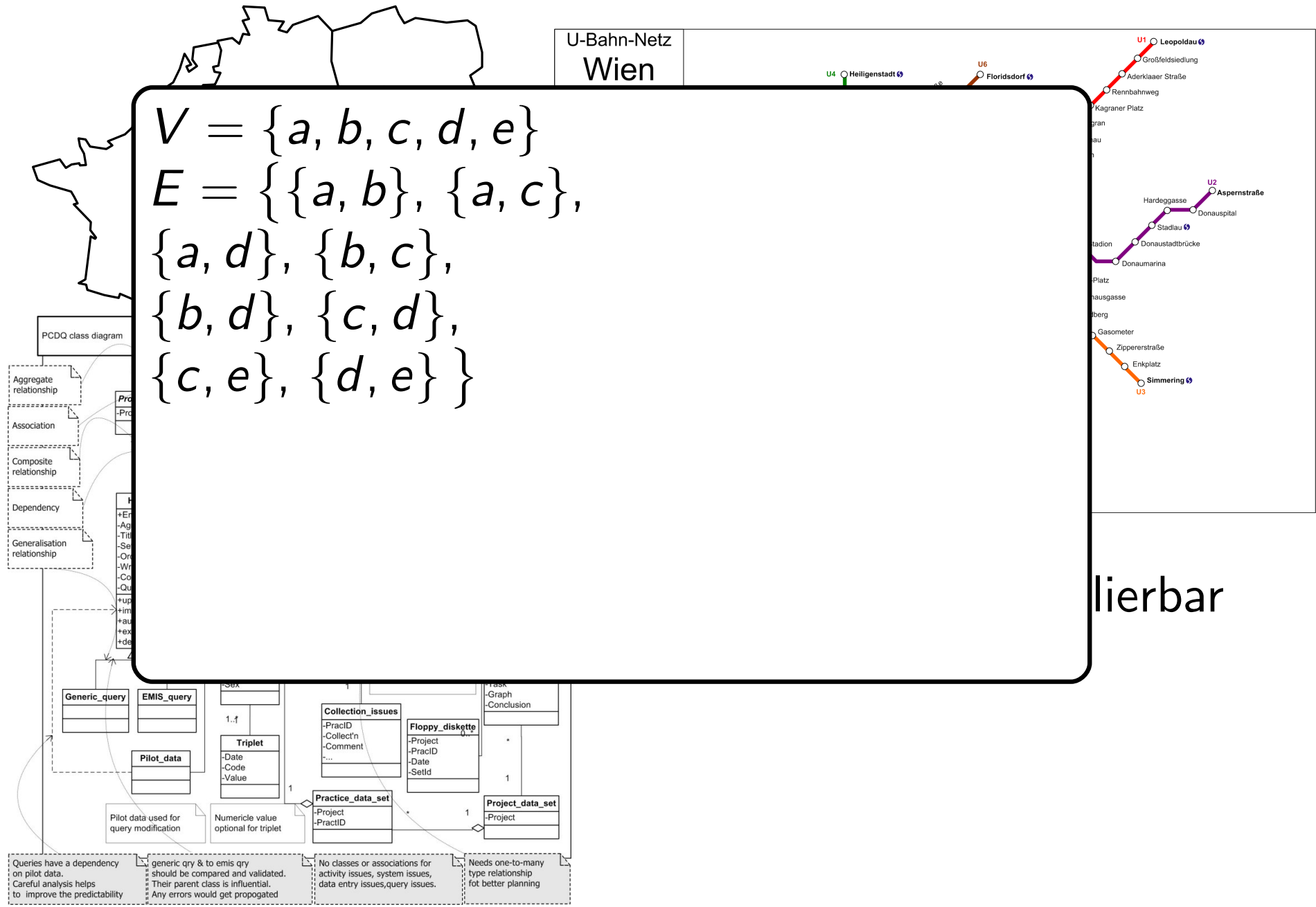

Warum Graphen zeichnen?

U-Bahn-Netz
Wien

$$V = \{a, b, c, d, e\}$$

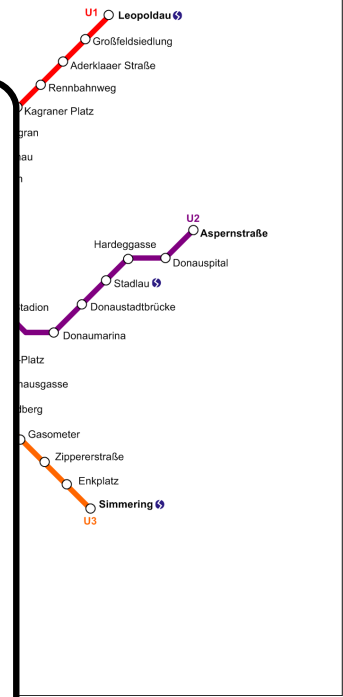
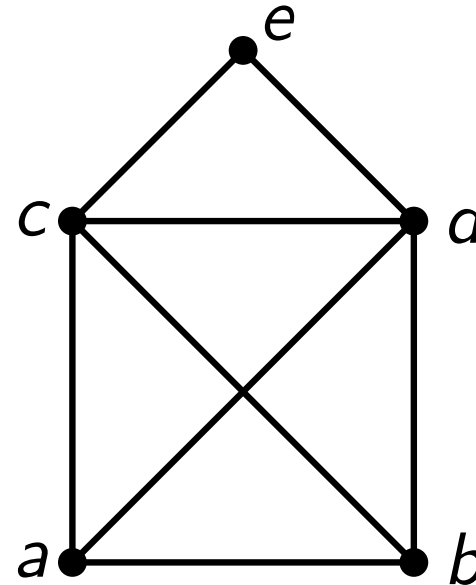
$$E = \{\{a, b\}, \{a, c\}, \{a, d\}, \{b, c\}, \{b, d\}, \{c, d\}, \{c, e\}, \{d, e\}\}$$

lierbar

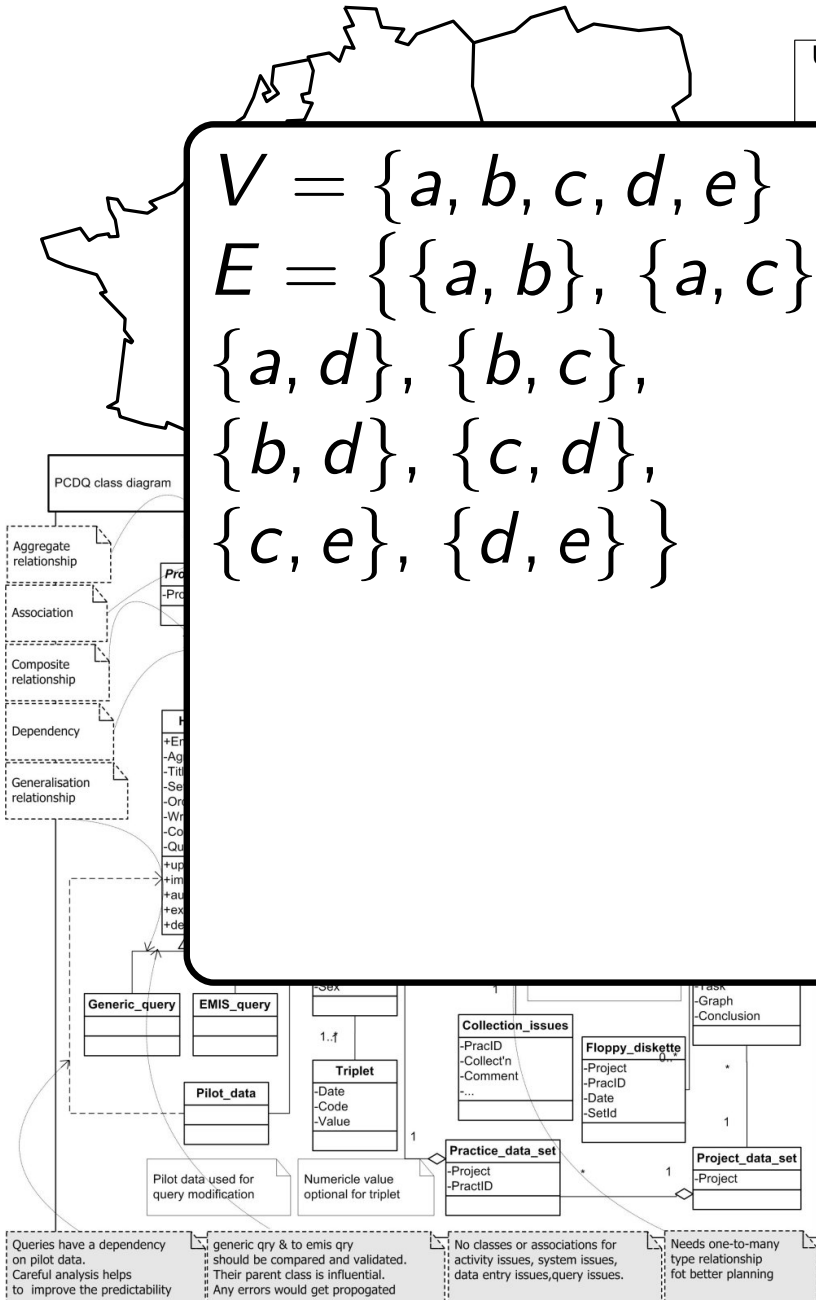

Queries have a dependency on pilot data. Careful analysis helps to improve the predictability

generic qry & to emis qry should be compared and validated. Their parent class is influential. Any errors would get propagated

No classes or associations for activity issues, system issues, data entry issues, query issues.

Needs one-to-many type relationship for better planning

Warum Graphen zeichnen?

U-Bahn-Netz
Wien

$V = \{a, b, c, d, e\}$
 $E = \{\{a, b\}, \{a, c\},$
 $\{a, d\}, \{b, c\},$
 $\{b, d\}, \{c, d\},$
 $\{c, e\}, \{d, e\}\}$

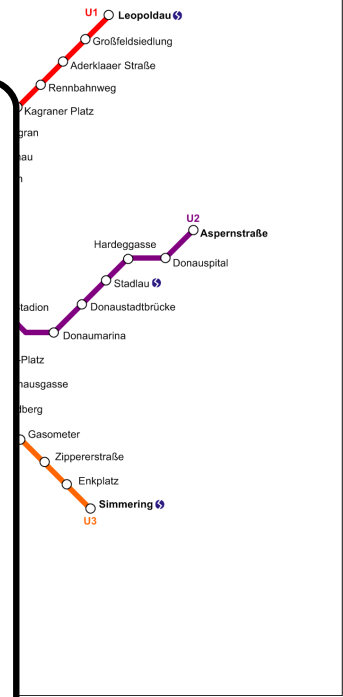
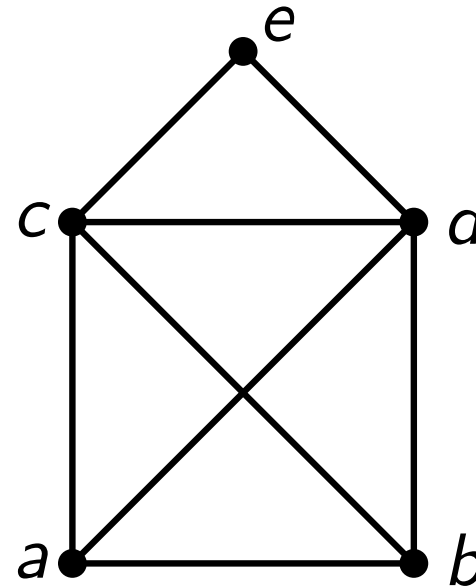

...lierbar

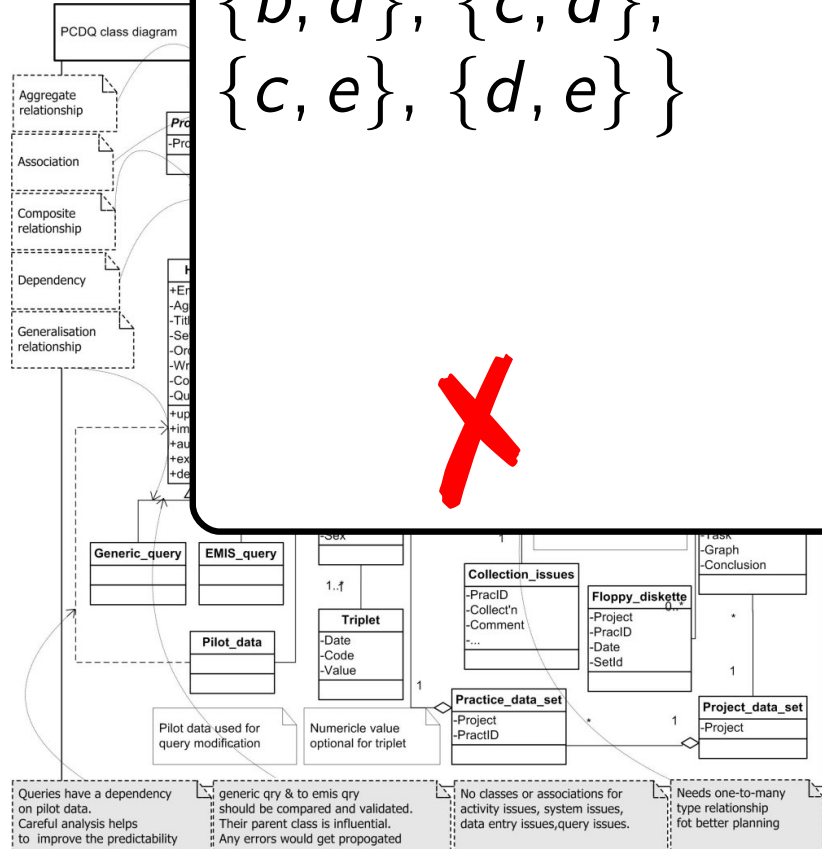

Constraints

- Kantendarstellung

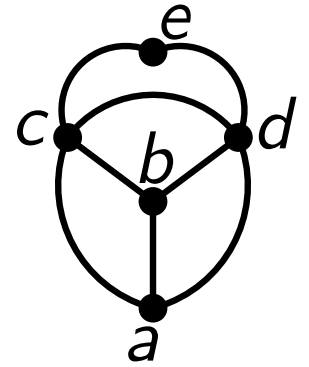
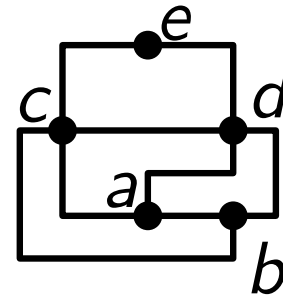
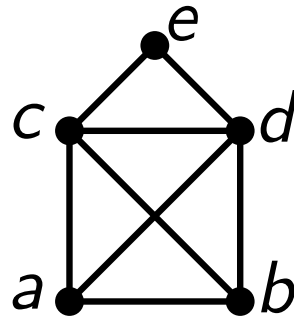

Constraints

- Kantendarstellung

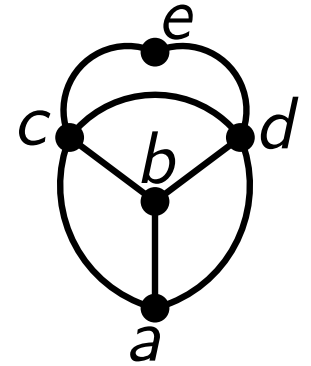
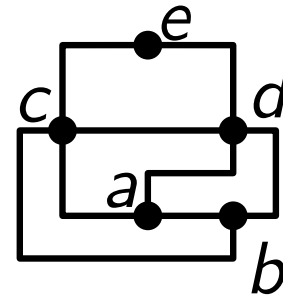
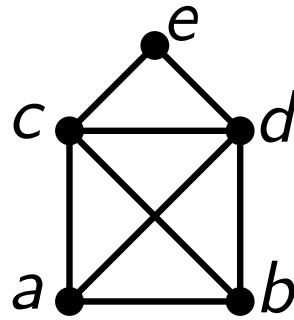

- Planarität

Constraints

- Kantendarstellung

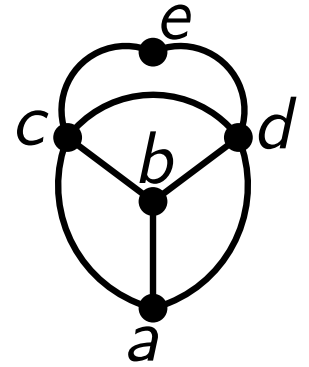
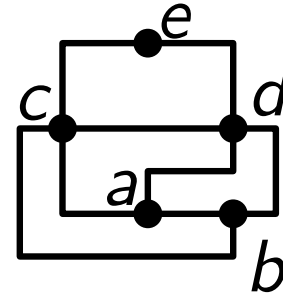
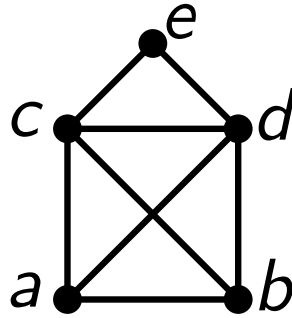

- Planarität

- Kreuzungswinkel

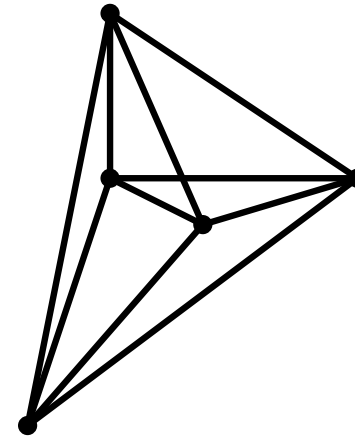
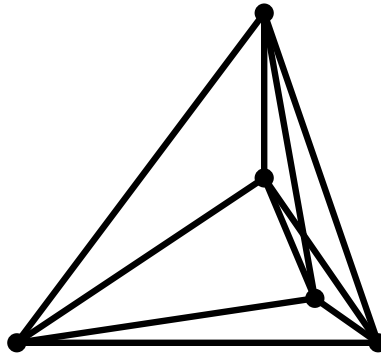

Constraints

- Kantendarstellung

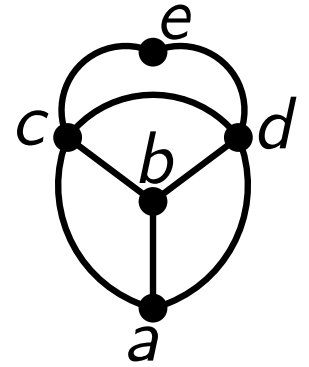
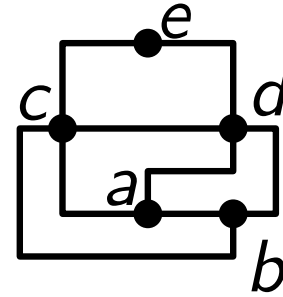
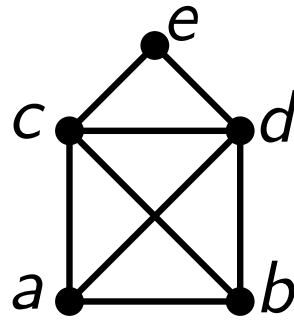

- Planarität

- Kreuzungswinkel

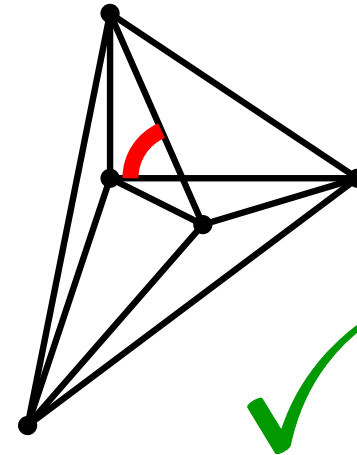
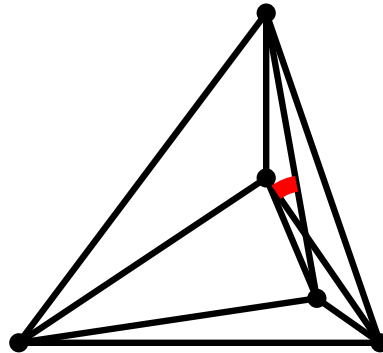

Constraints

- Kantendarstellung

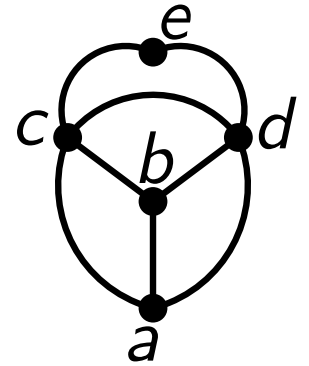
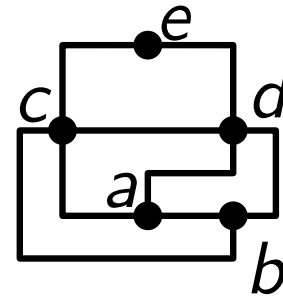
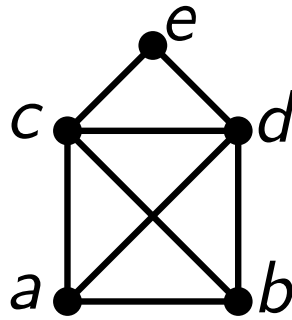

- Planarität

- Kreuzungswinkel

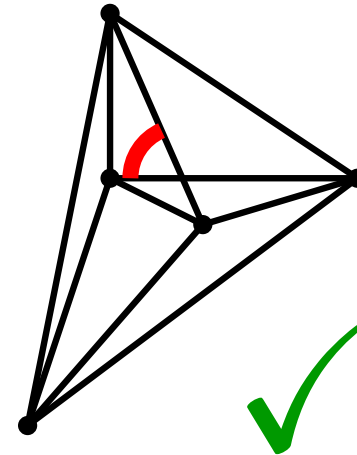
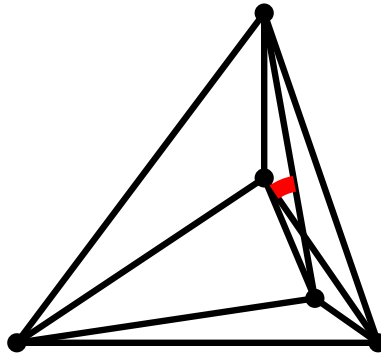

- Knotenpositionen

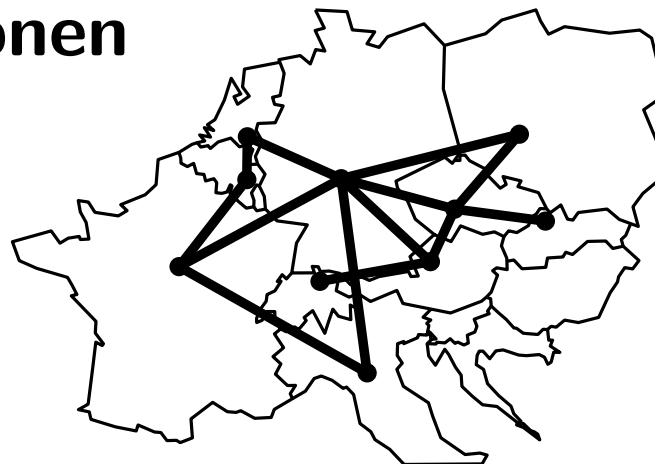

Gliederung

- **Teil I: U-Bahn-Linienpläne**
- **Teil II: Punktmengen-Einbettbarkeit**
- **Teil III: Randbeschriftungen**

Teil I: U-Bahn-Linienpläne

Métro Paris



Würzburg

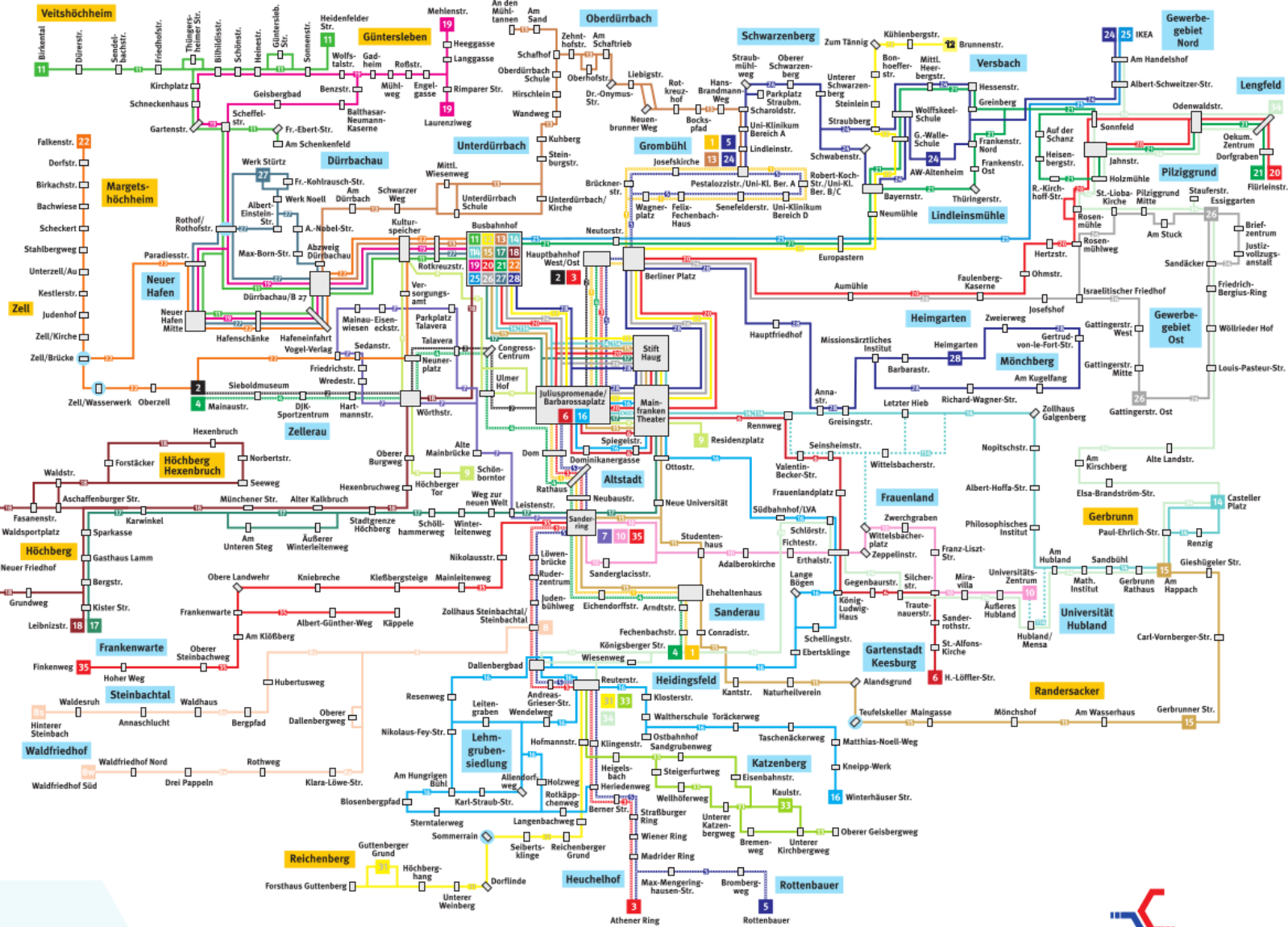

Bisher: schematische Pläne

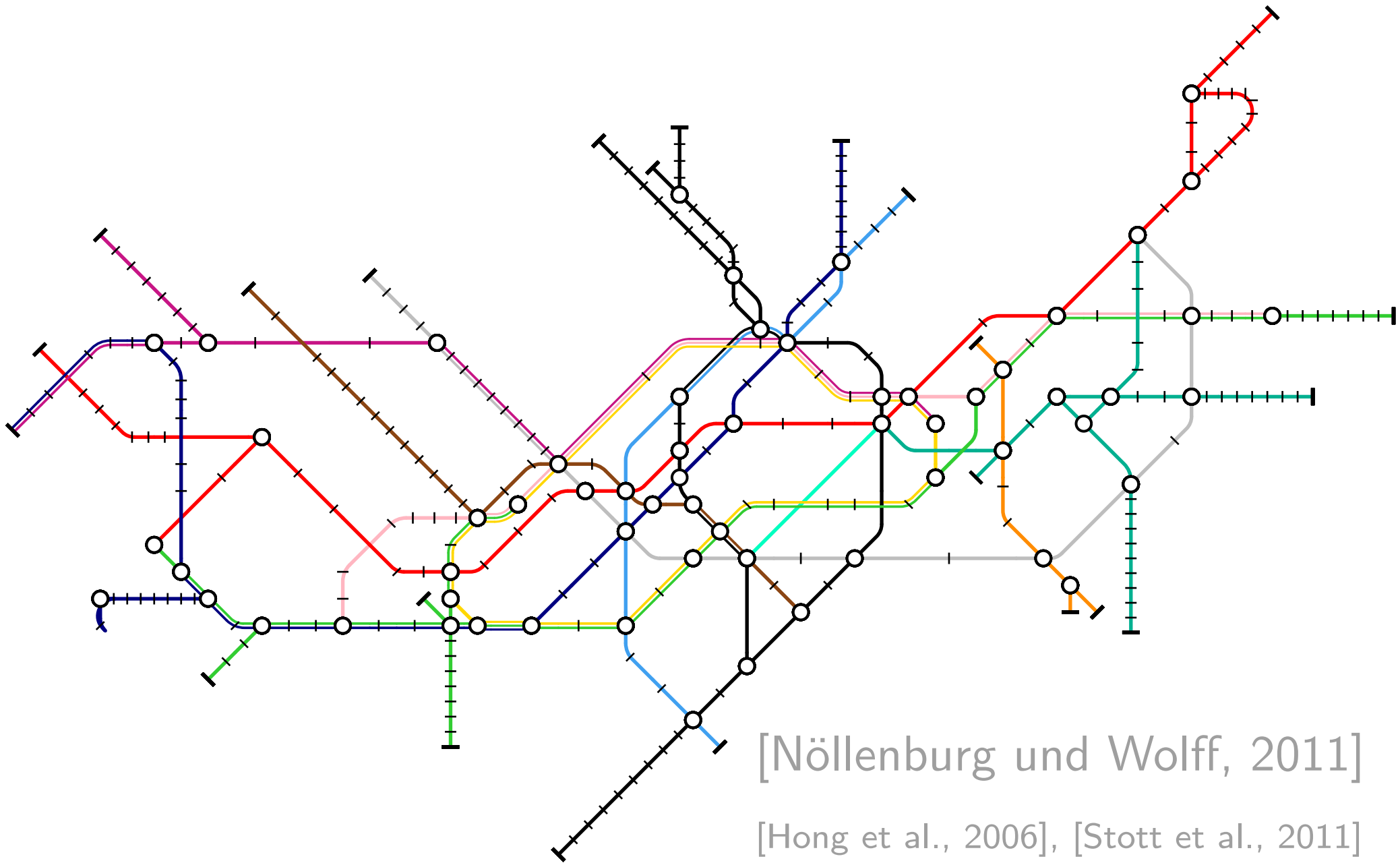

[Nöllenburg und Wolff, 2011]

[Hong et al., 2006], [Stott et al., 2011]

Wunsch: kurviger Plan

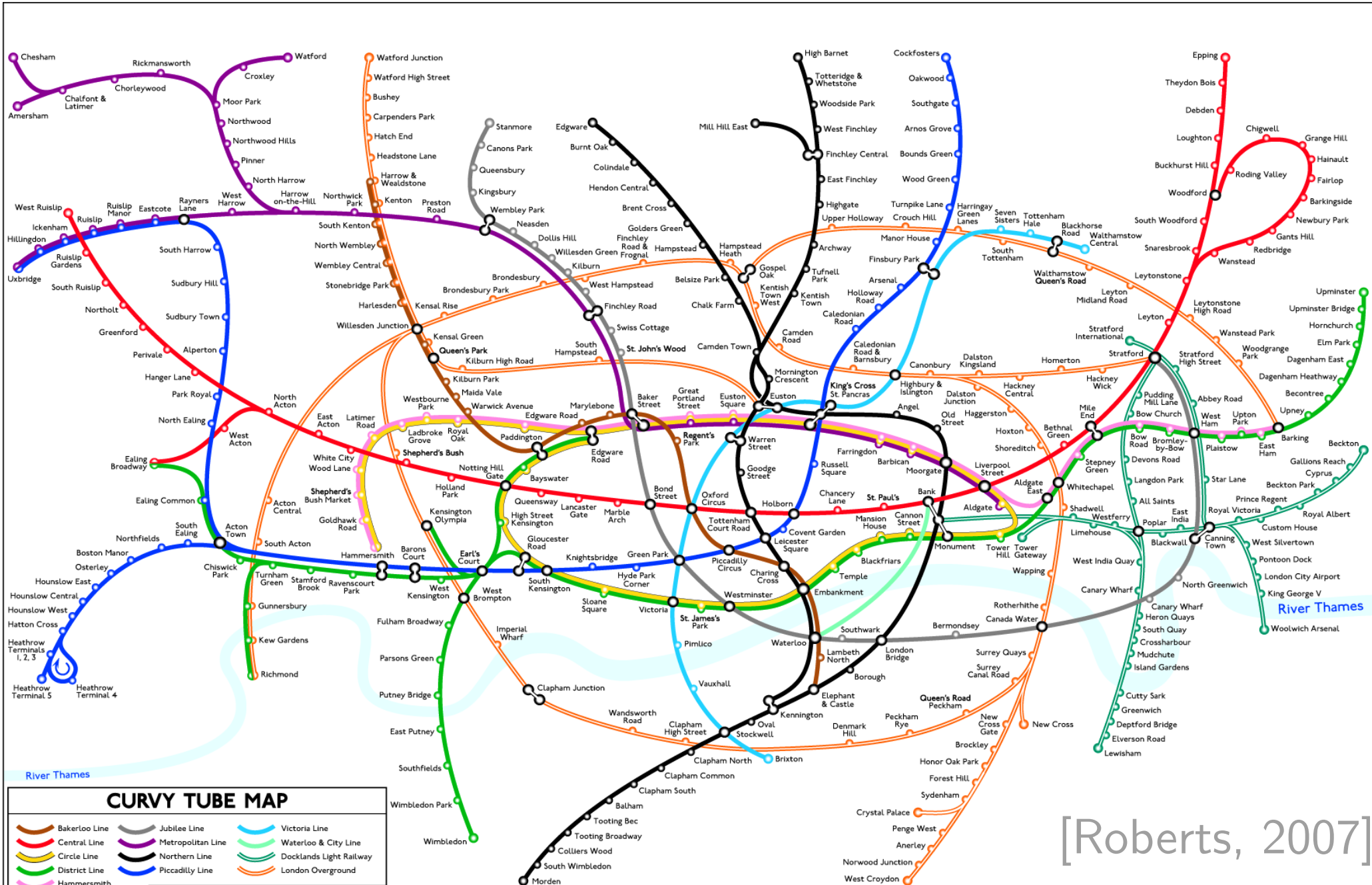

CURVY TUBE MAP

Station
 Interchange between lines
 Overground

A curves-only diagrammatic map of TfL supported railways, © Maxwell J. Roberts, 30/01/2008

[Roberts, 2007]

THIS MAP IS DERIVED FROM REGISTERED DESIGN NO. 400180: A CURVES-ONLY DIAGRAMMATIC MAP OF THE LONDON UNDERGROUND © MAXWELL J. ROBERTS, 26/02/2007

Wunsch: kurviger Plan

bis zu 50% schnellere Reiseplanung
[Roberts et al., 2013]

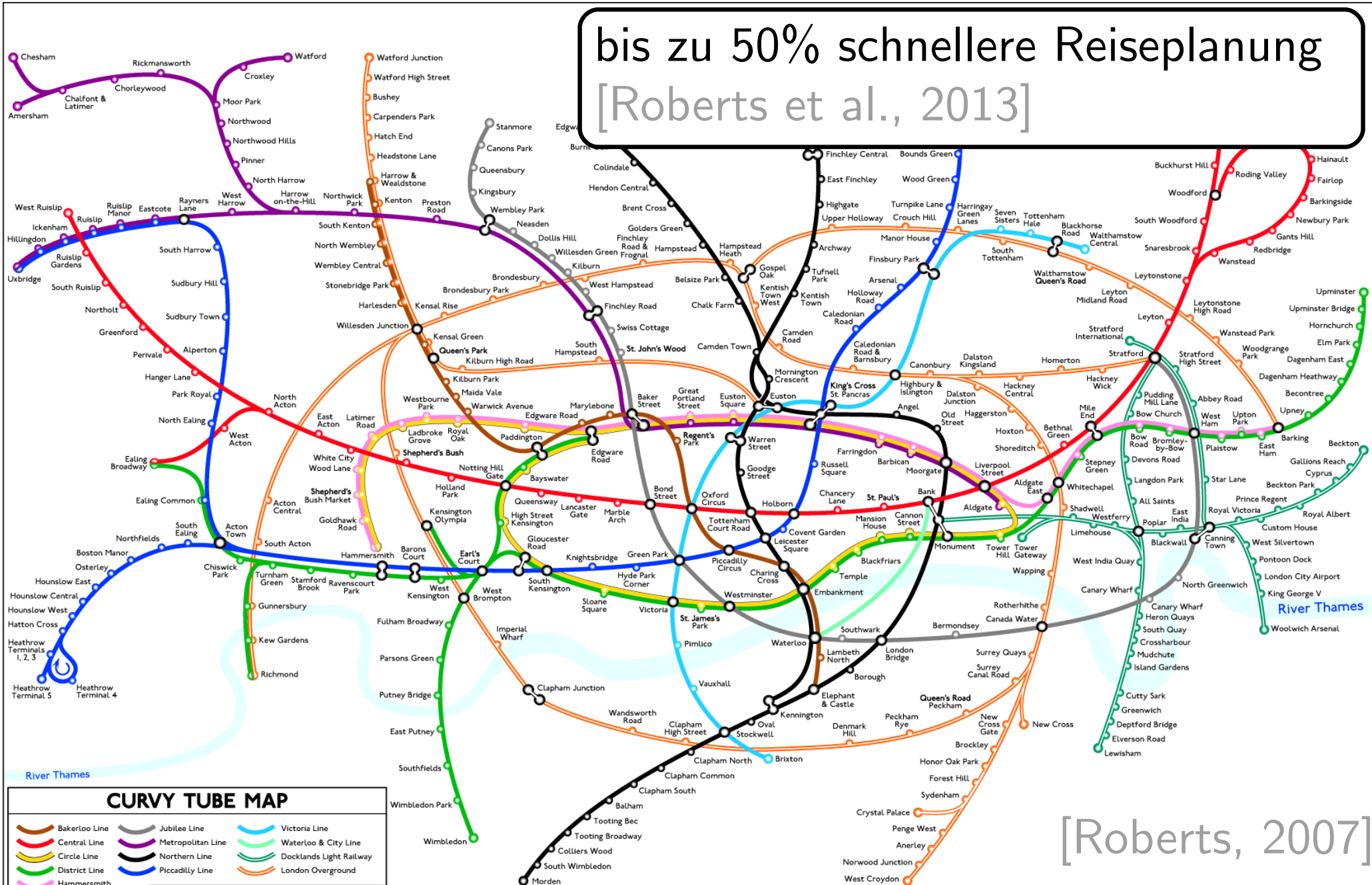

[Roberts, 2007]

CURVY TUBE MAP

Station
 Interchange between Lines

A curves-only diagrammatic map of TfL supported railways, © Maxwell J. Roberts, 30/01/2008

THIS MAP IS DERIVED FROM REGISTERED DESIGN NO. 400180: A CURVES-ONLY DIAGRAMMATIC MAP OF THE LONDON UNDERGROUND © MAXWELL J. ROBERTS, 26/02/2007

Unser Verfahren mit Bézierkurven

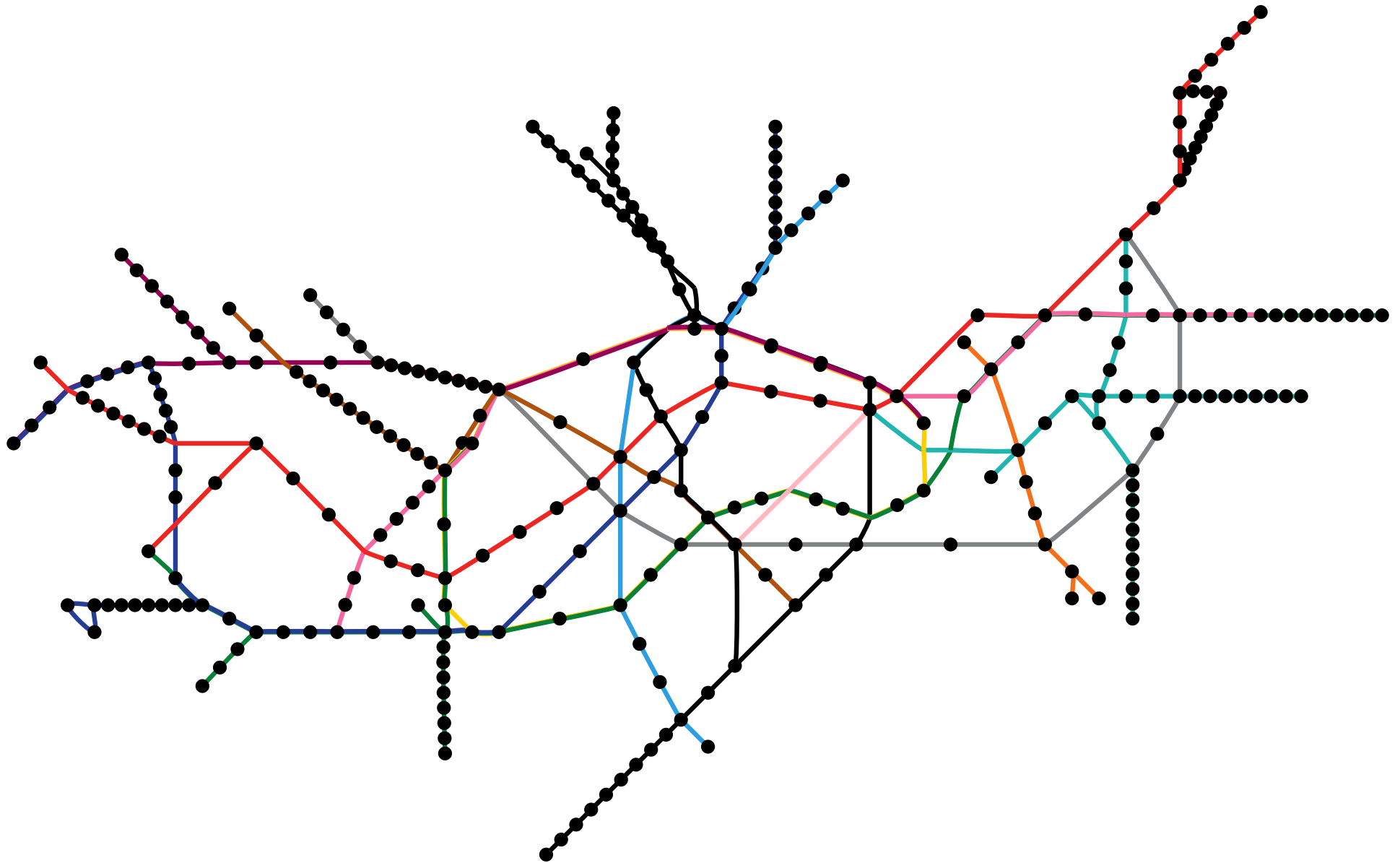

Unser Verfahren mit Bézierkurven

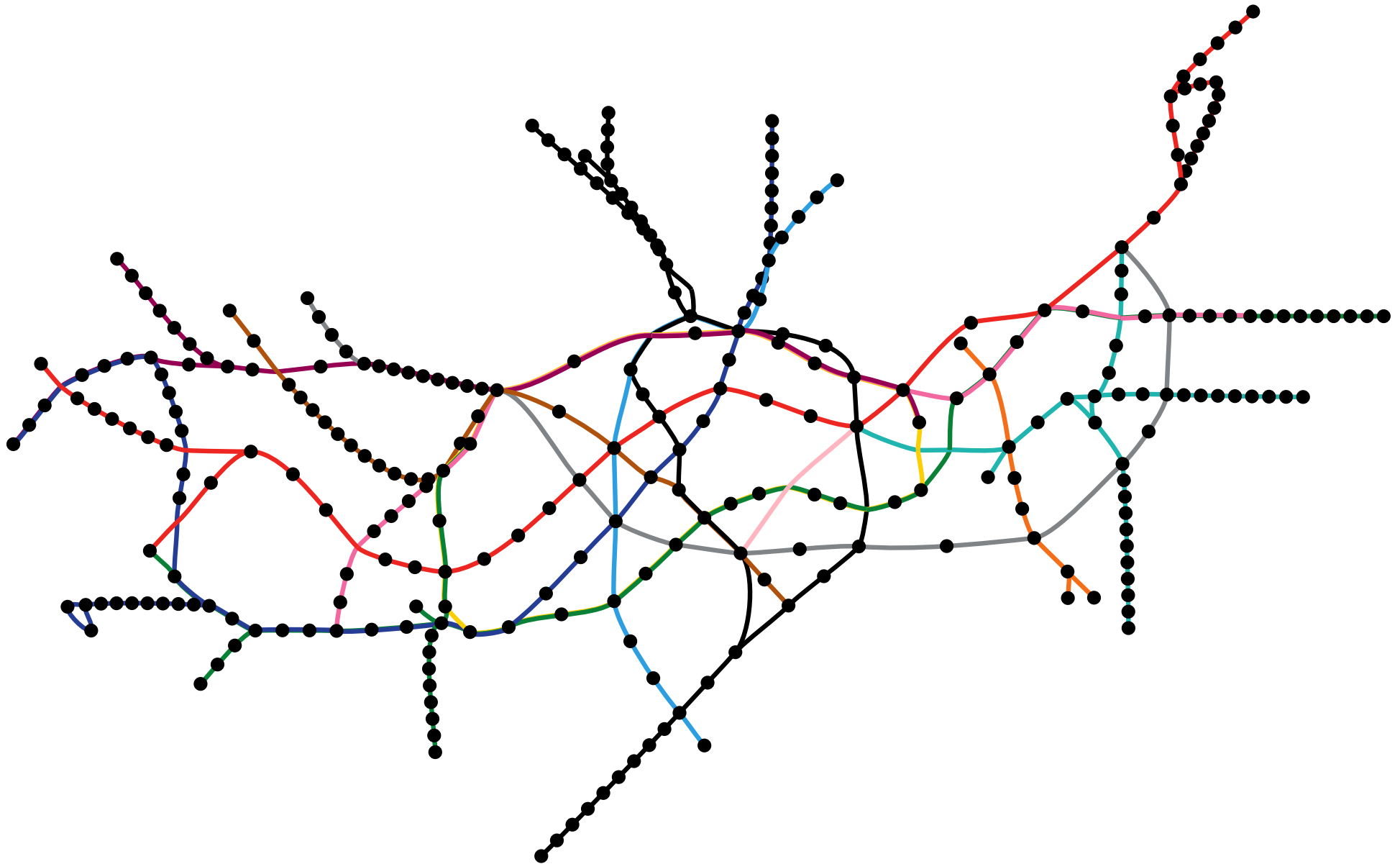

Unser Verfahren mit Bézierkurven

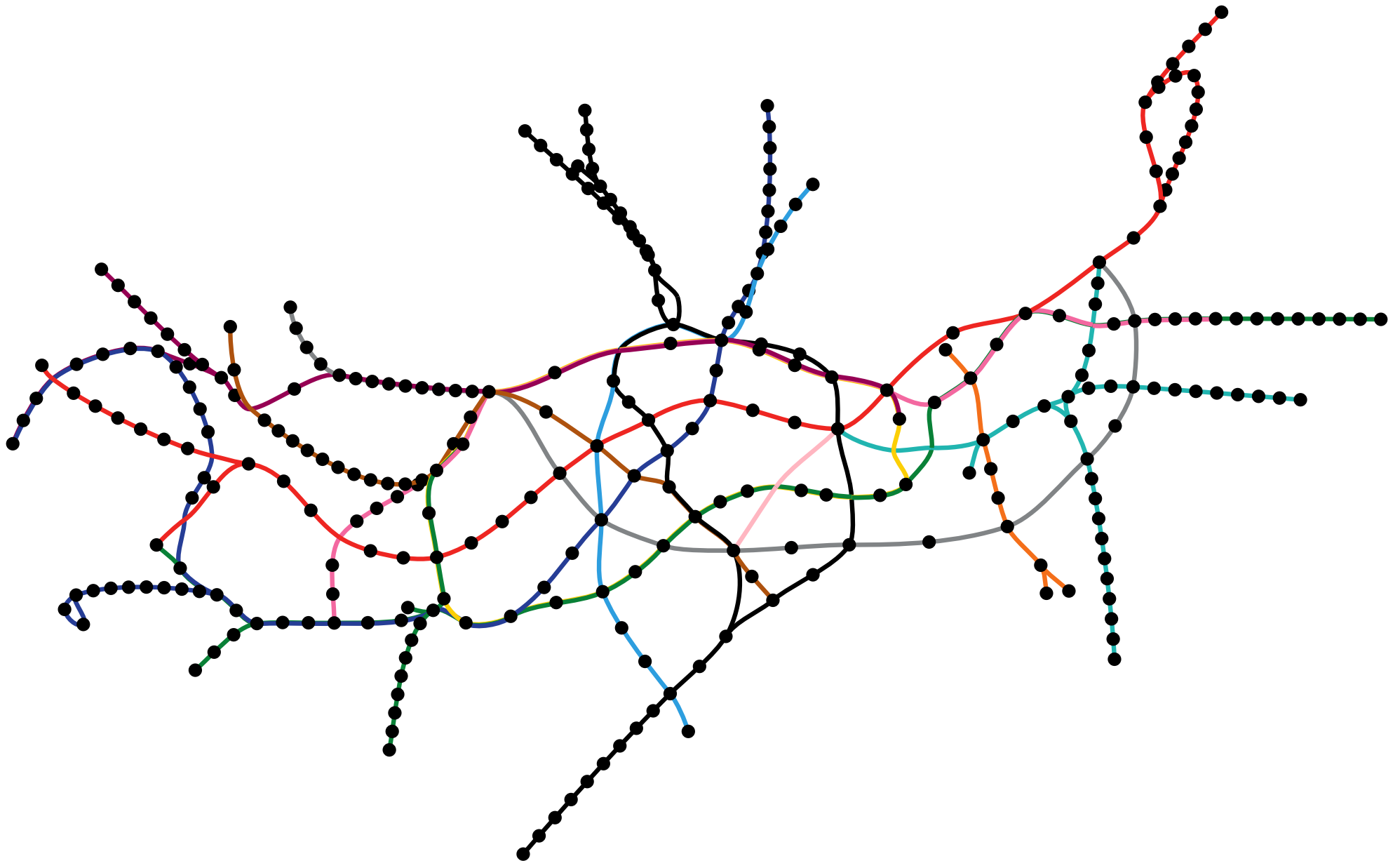

Unser Verfahren mit Bézierkurven

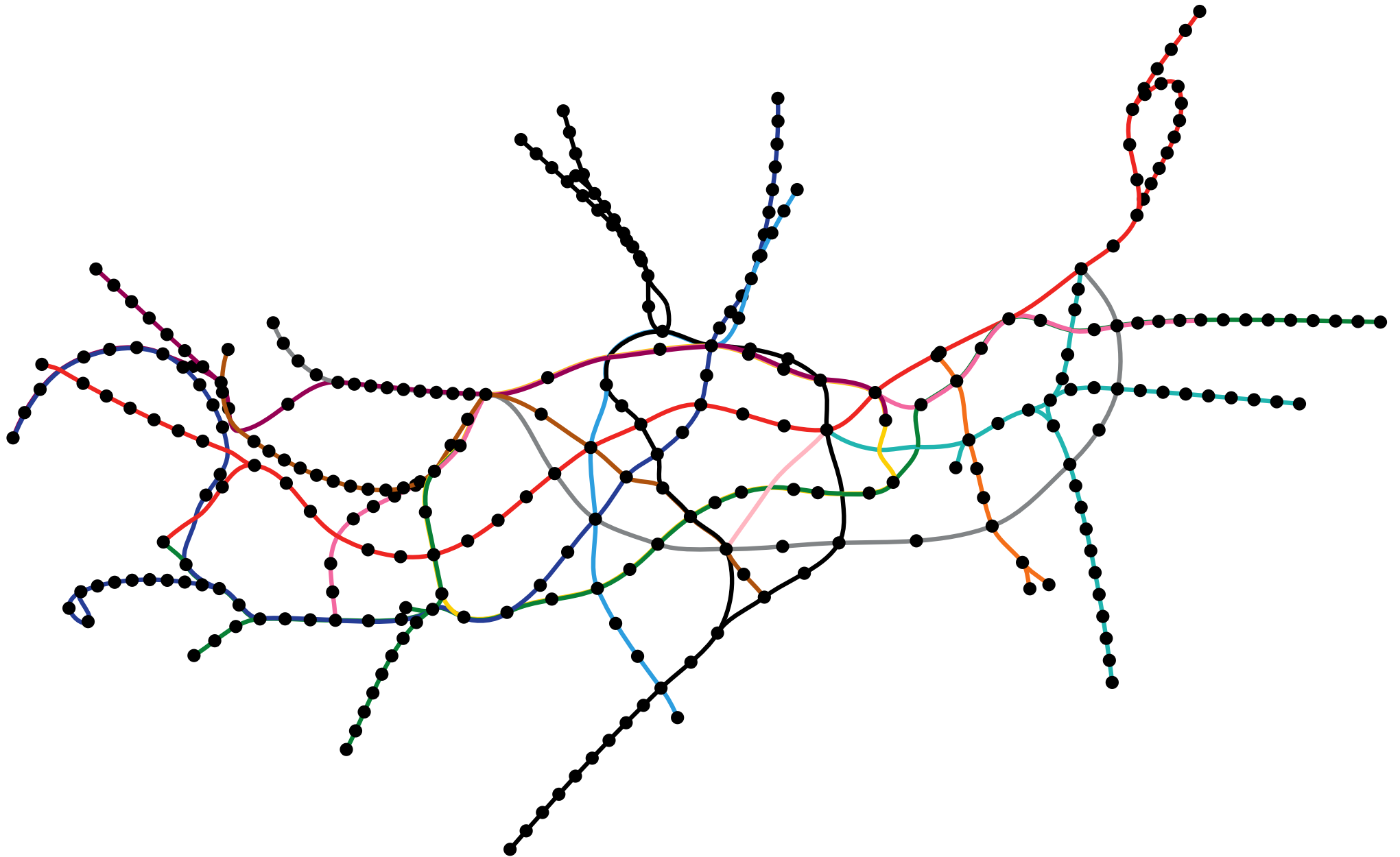

Unser Verfahren mit Bézierkurven

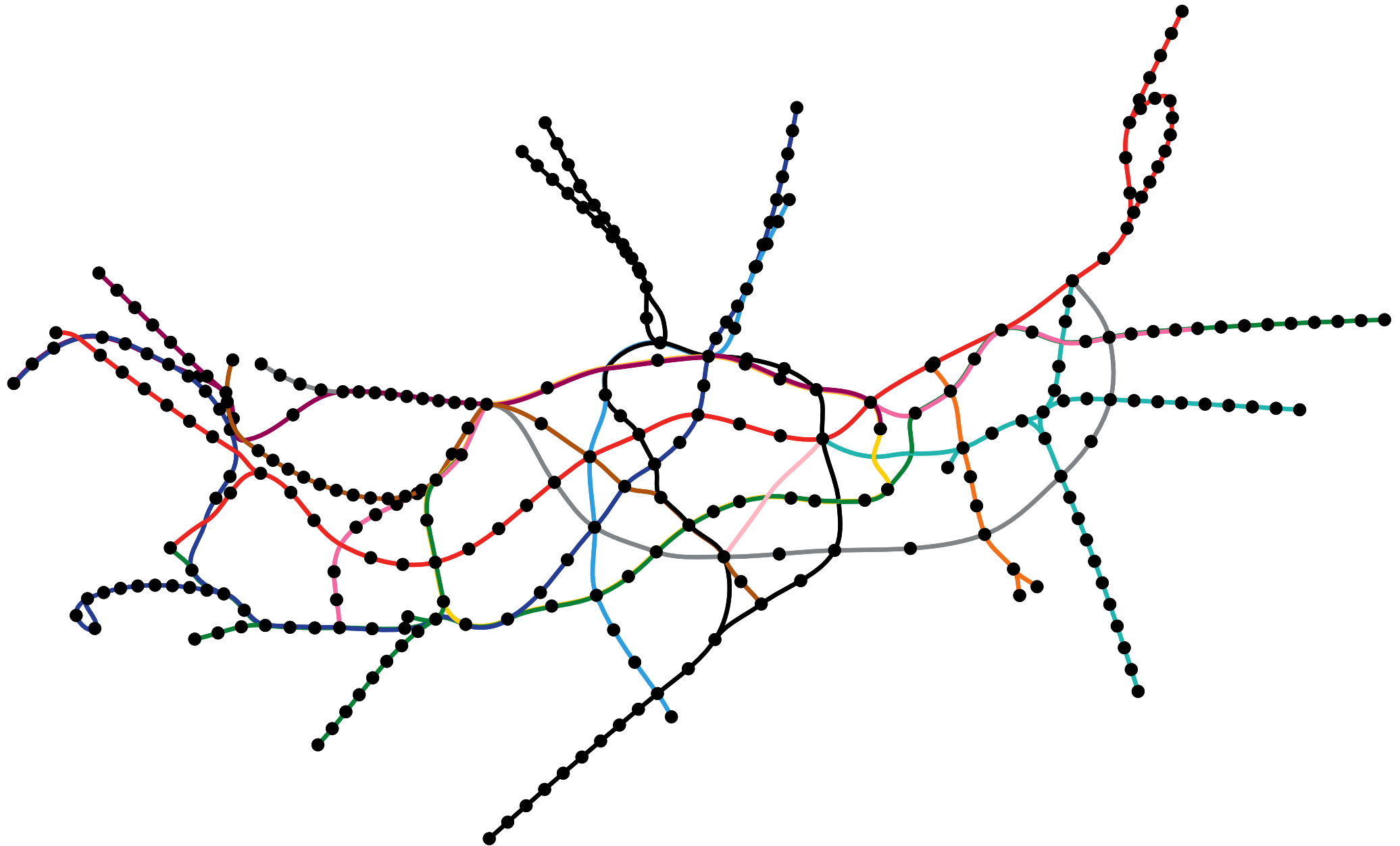

Unser Verfahren mit Bézierkurven

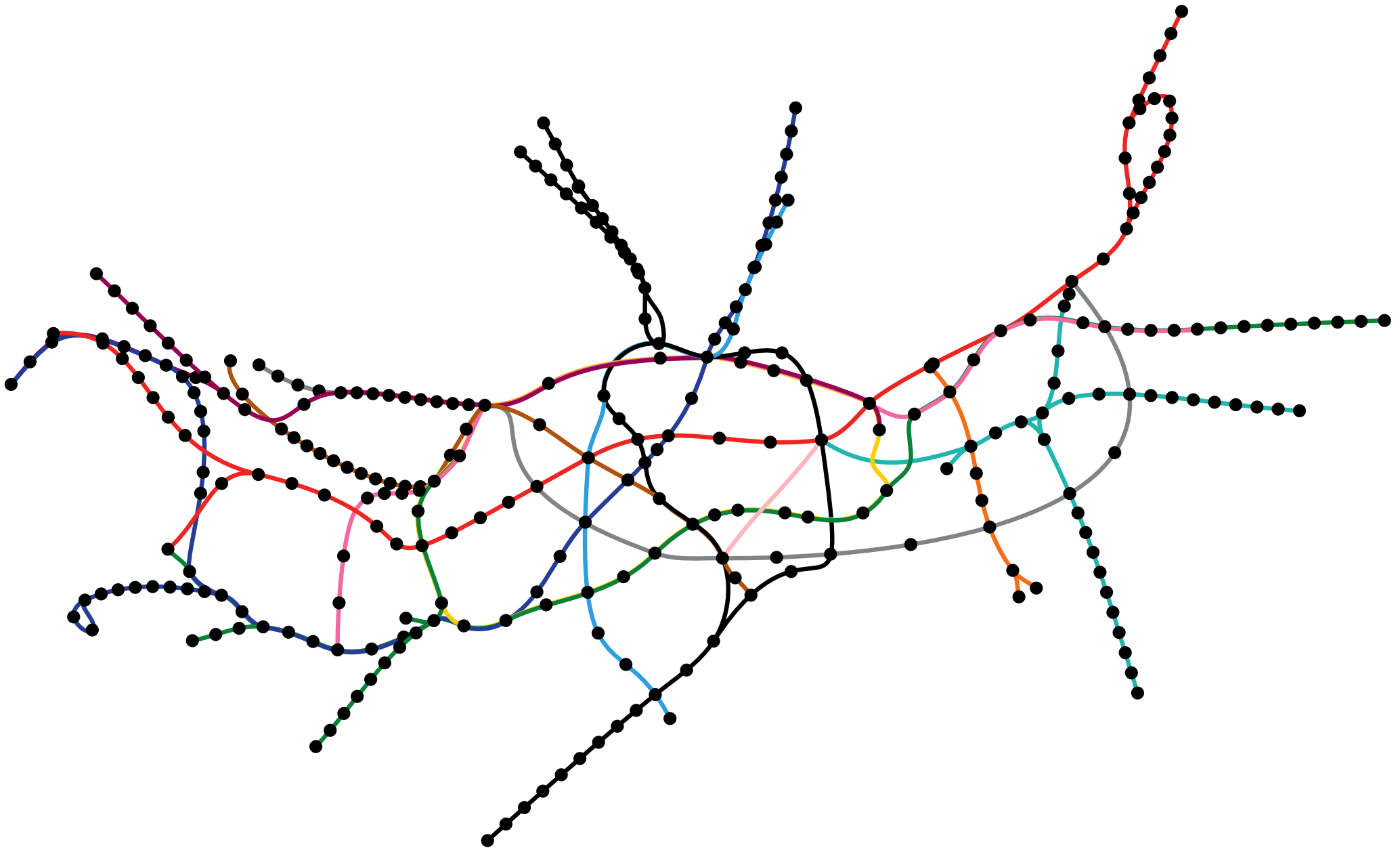

Unser Verfahren mit Bézierkurven

kräftebasierterer Ansatz:

- iterative Verbesserung
- Kräfte drücken Zeichnung in gewünschte Richtung

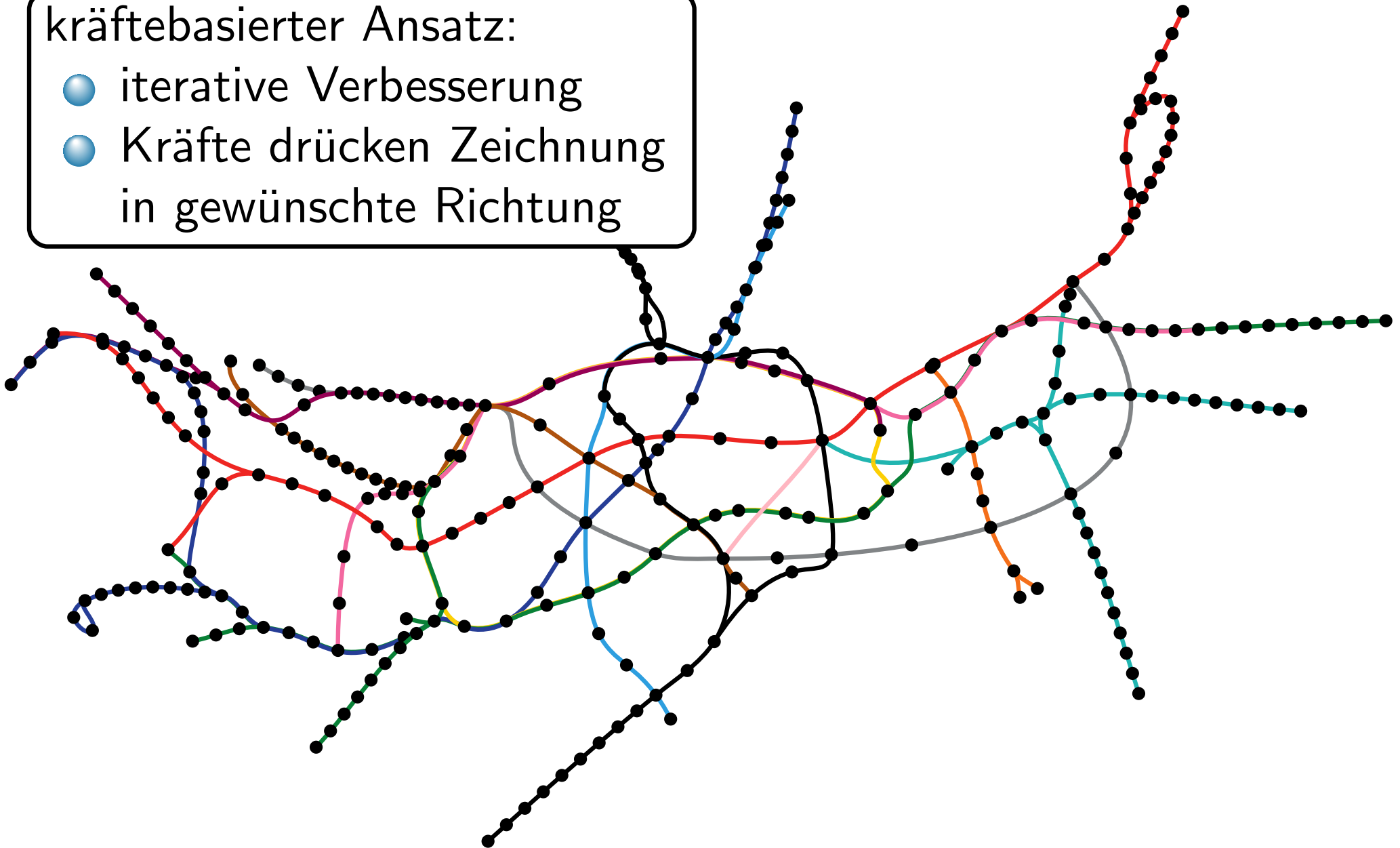

Wien

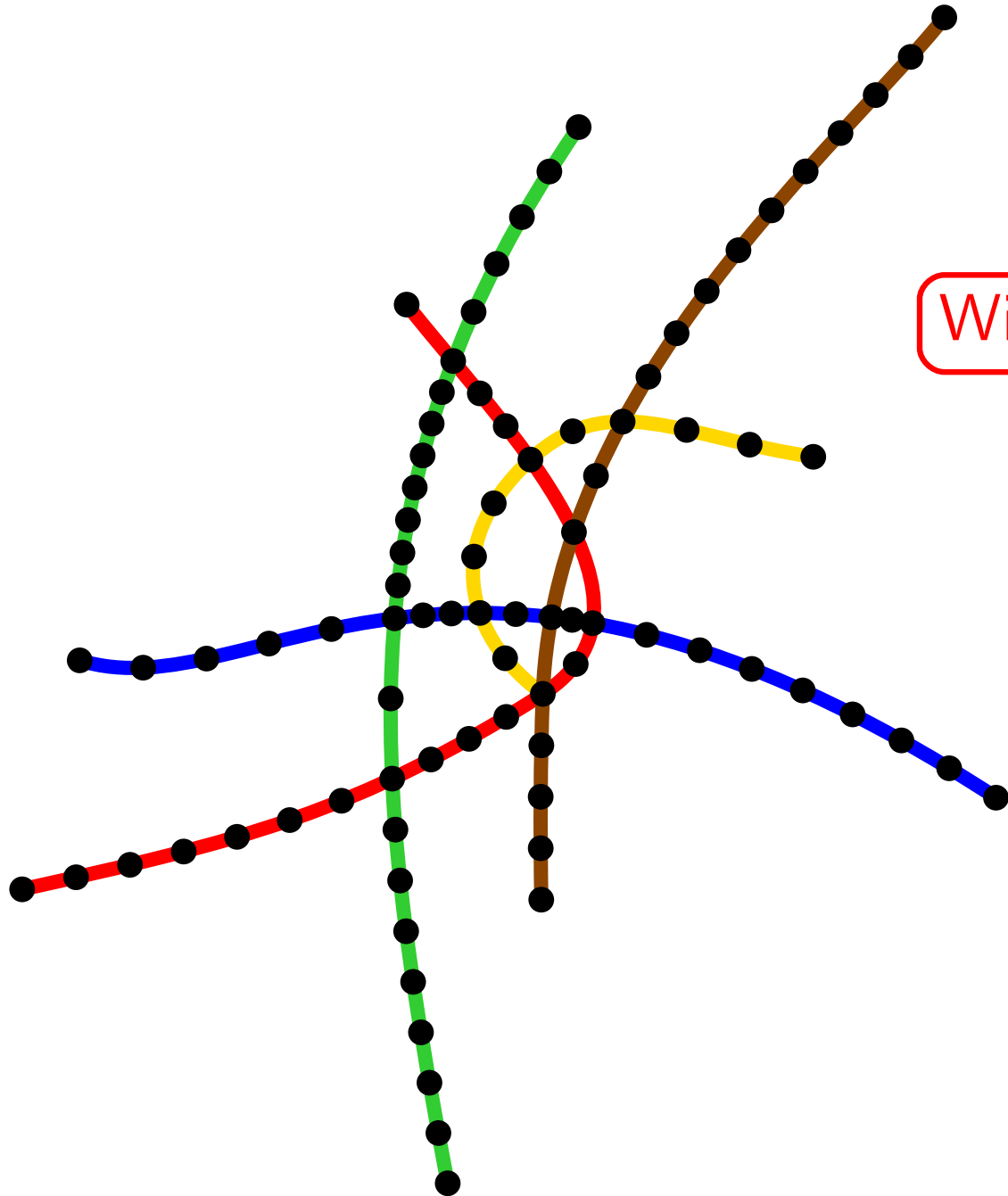

Wichtig: Verschmelze Kurven!

U-Bahn-Linien



U-Bahn-Linien



eine Kante – viele
U-Bahn-Linien

U-Bahn-Linien



Kreuzungsminimierung

Füge (U-Bahn-)Linien L so in *eingebetteten Graphen* $G = (V, E)$ ein, dass ...

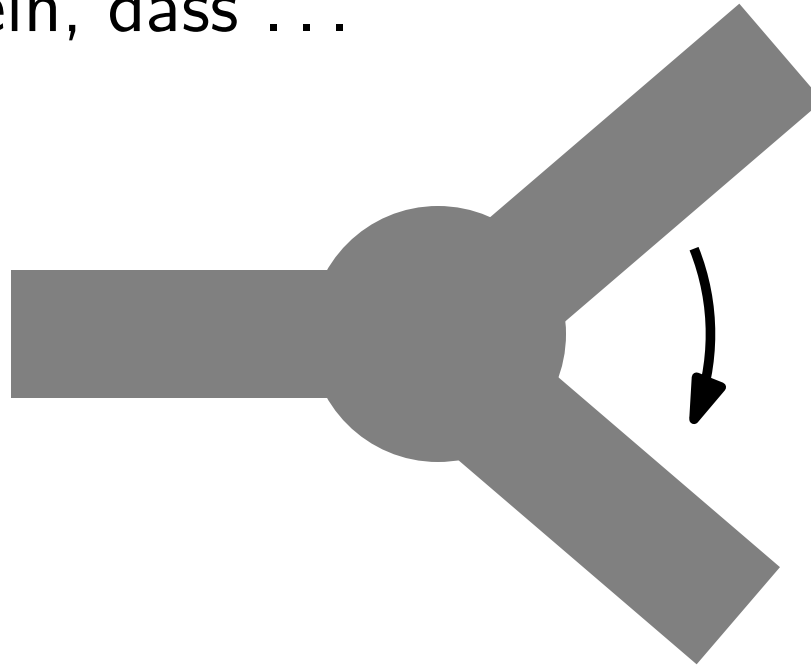

Kreuzungsminimierung

Füge (U-Bahn-)Linien L so in *eingebetteten Graphen* $G = (V, E)$ ein, dass ...

- #Kreuzungen minimal.
- Kreuzungen auf Kanten platziert.

Annahmen:

- Linien sind einfache Pfade.
- Linien schneiden sich in Pfaden.

Kreuzungsminimierung

Füge (U-Bahn-)Linien L so in *eingebetteten Graphen* $G = (V, E)$ ein, dass ...

- #Kreuzungen minimal.
- Kreuzungen auf Kanten platziert.



Annahmen:

- Linien sind einfache Pfade.
- Linien schneiden sich in Pfaden.

Kreuzungsminimierung

Füge (U-Bahn-)Linien L so in *eingebetteten Graphen* $G = (V, E)$ ein, dass ...

- #Kreuzungen minimal.
- Kreuzungen auf Kanten platziert.

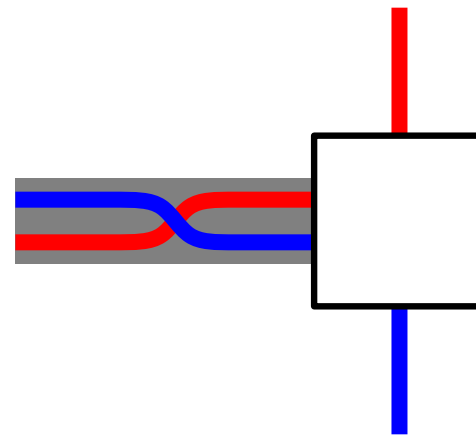
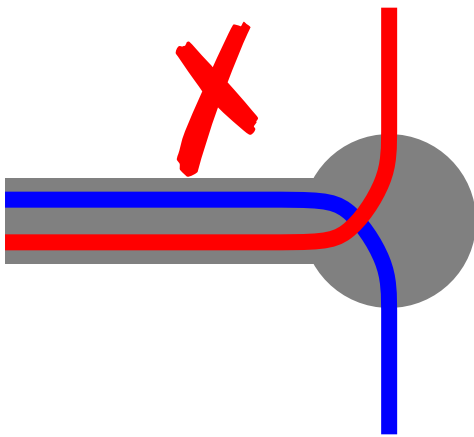

Annahmen:

- Linien sind einfache Pfade.
- Linien schneiden sich in Pfaden.

Kreuzungsminimierung

Füge (U-Bahn-)Linien L so in *eingebetteten Graphen* $G = (V, E)$ ein, dass ...

- #Kreuzungen minimal.
- Kreuzungen auf Kanten platziert.

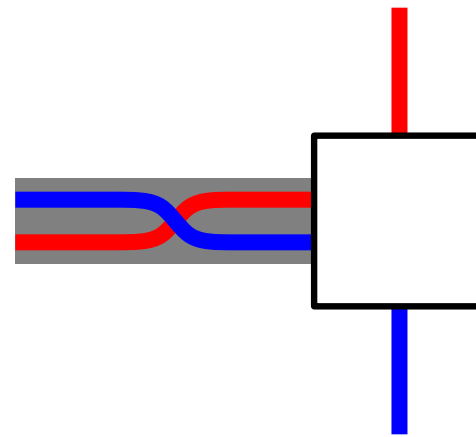
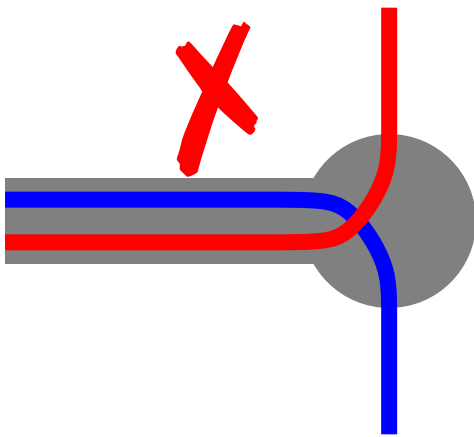

Hauptergebnisse:

- Allgemeines Problem NP-schwer.
- $O(\sqrt{\log |L|})$ -Approximation für (NP-schwere) Variante

Neues Modell: Blockkreuzungen

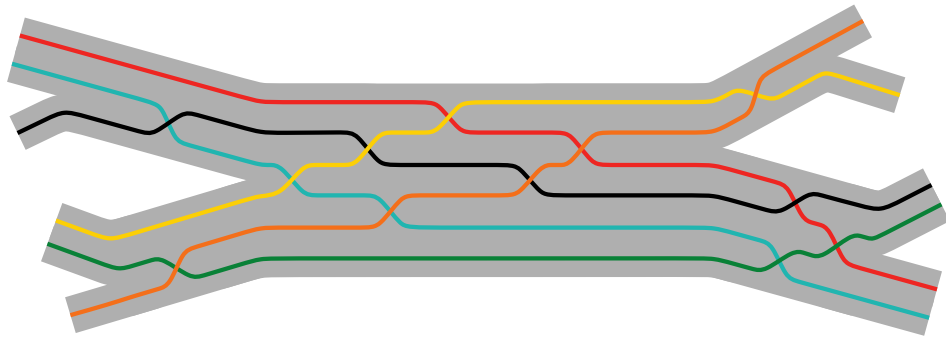

12 Kreuzungen

Neues Modell: Blockkreuzungen

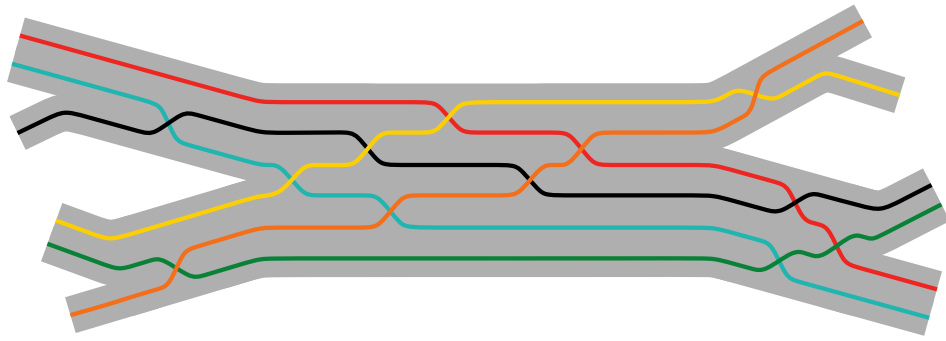

12 Kreuzungen

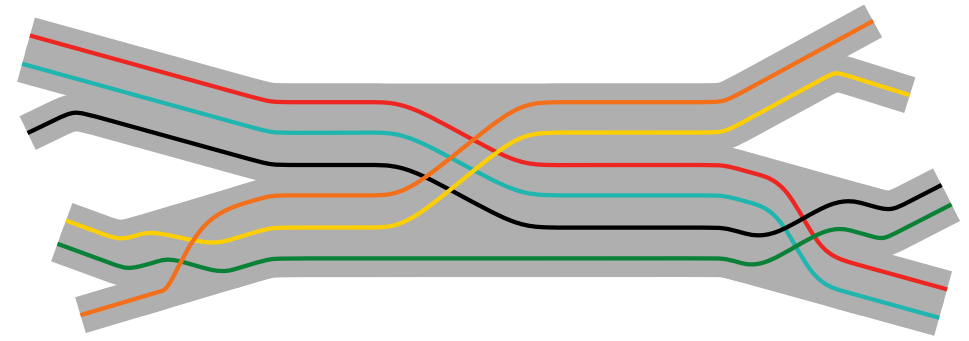

12 Kreuzungen

Neues Modell: Blockkreuzungen

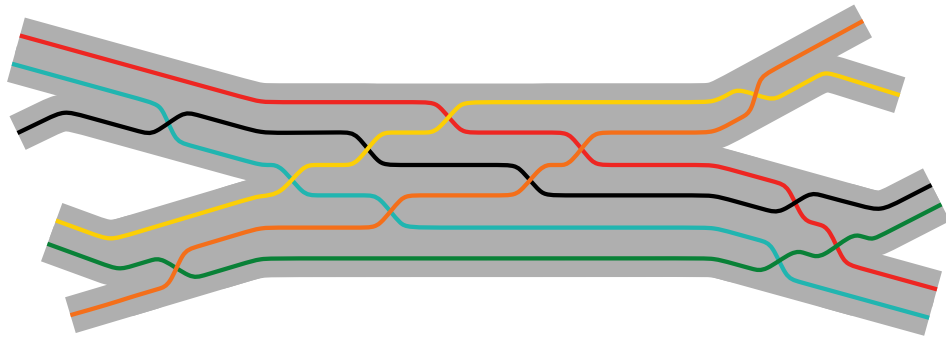

12 Kreuzungen

12 Blockkreuzungen

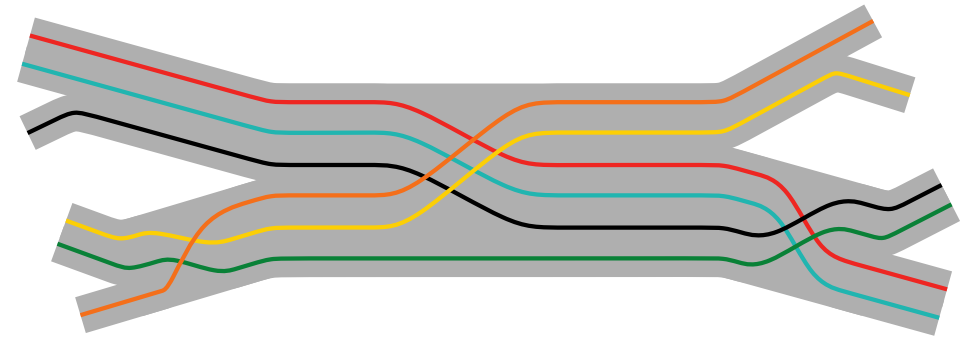

12 Kreuzungen

3 Blockkreuzungen

Neues Modell: Blockkreuzungen

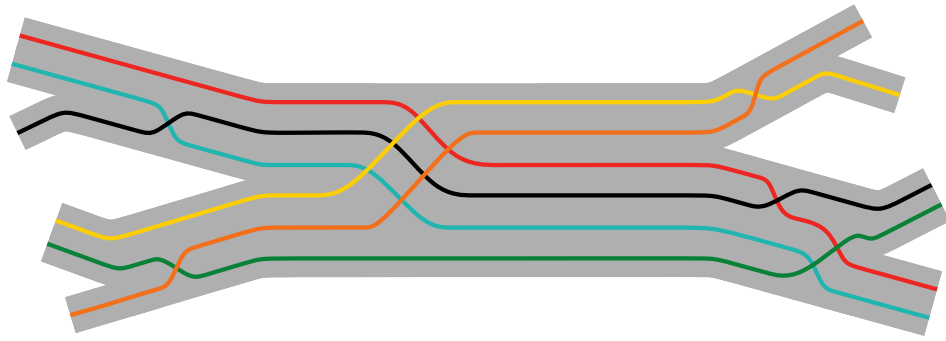

12 Kreuzungen

6 ~~12~~ Blockkreuzungen

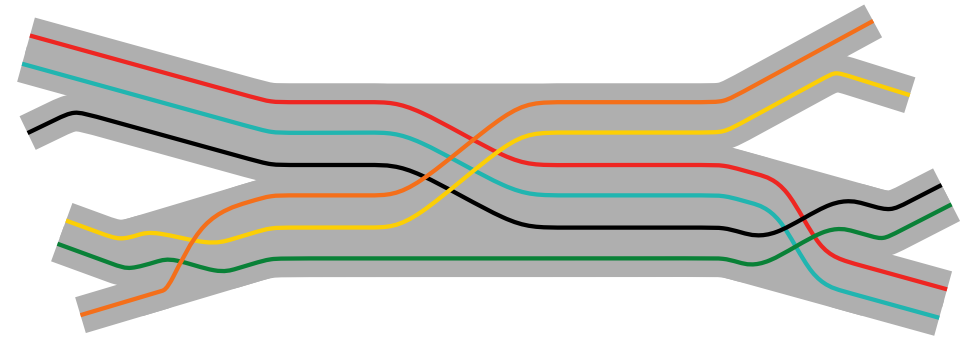

12 Kreuzungen

3 Blockkreuzungen

Neues Modell: Blockkreuzungen

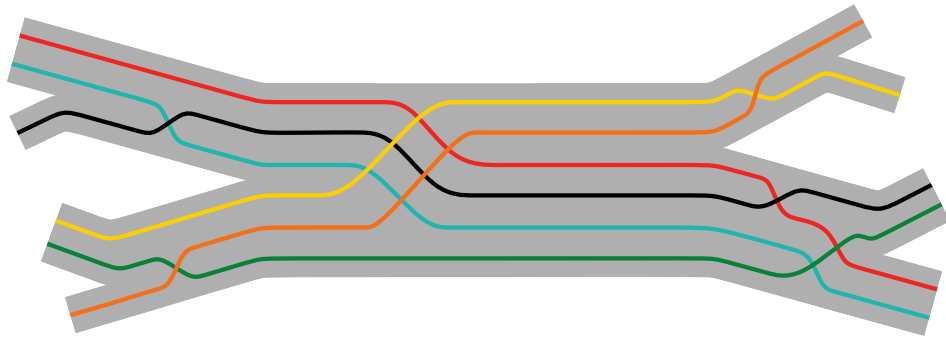

12 Kreuzungen

6 ~~12~~ Blockkreuzungen

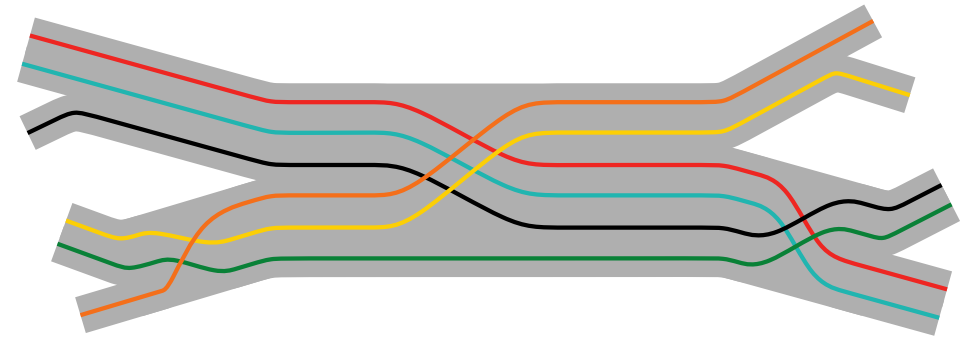

12 Kreuzungen

3 Blockkreuzungen

#Blockkreuzungen besseres Qualitätsmaß

Neues Modell: Blockkreuzungen

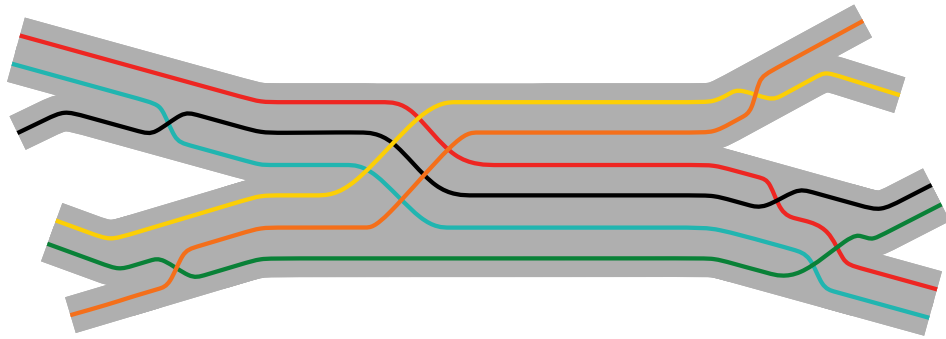

12 Kreuzungen

6 ~~12~~ Blockkreuzungen

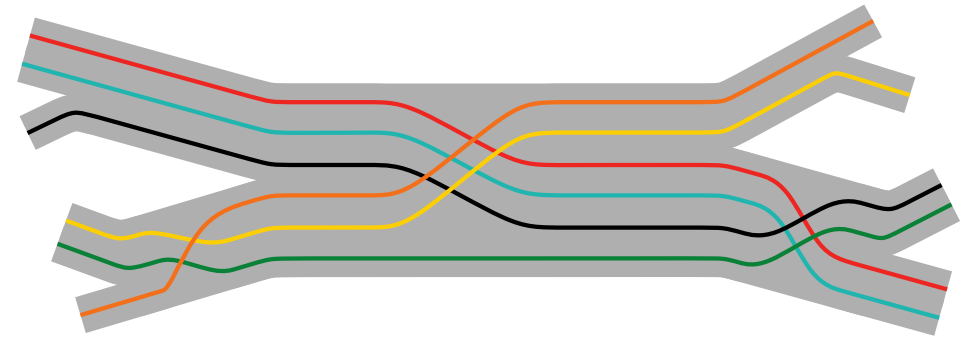

12 Kreuzungen

3 Blockkreuzungen

➔ #Blockkreuzungen besseres Qualitätsmaß

Blockkreuzung:

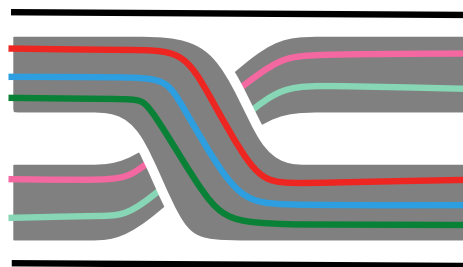

Linien in selbem Block parallel

Blockkreuzungen auf einer Kante



Blockkreuzungen auf einer Kante



Blockkreuzungen auf einer Kante

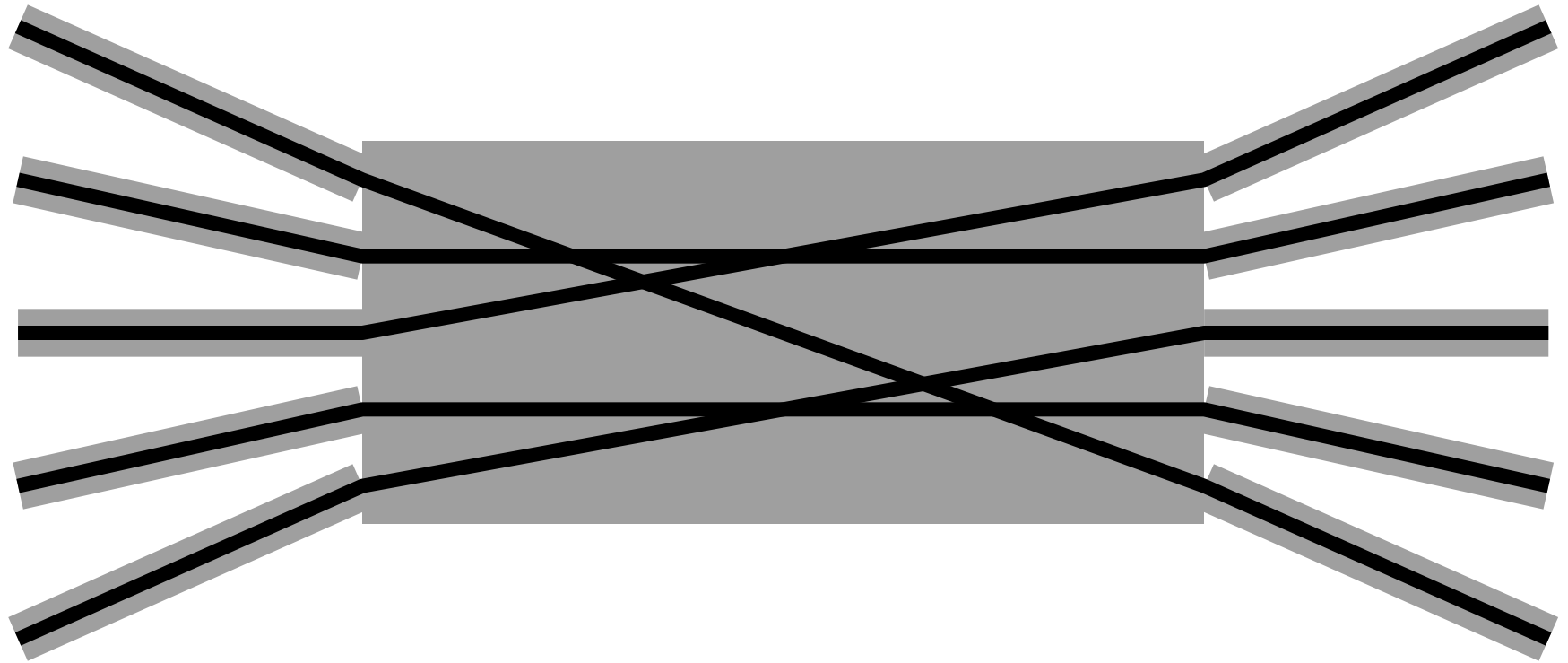

Blockkreuzungen auf einer Kante

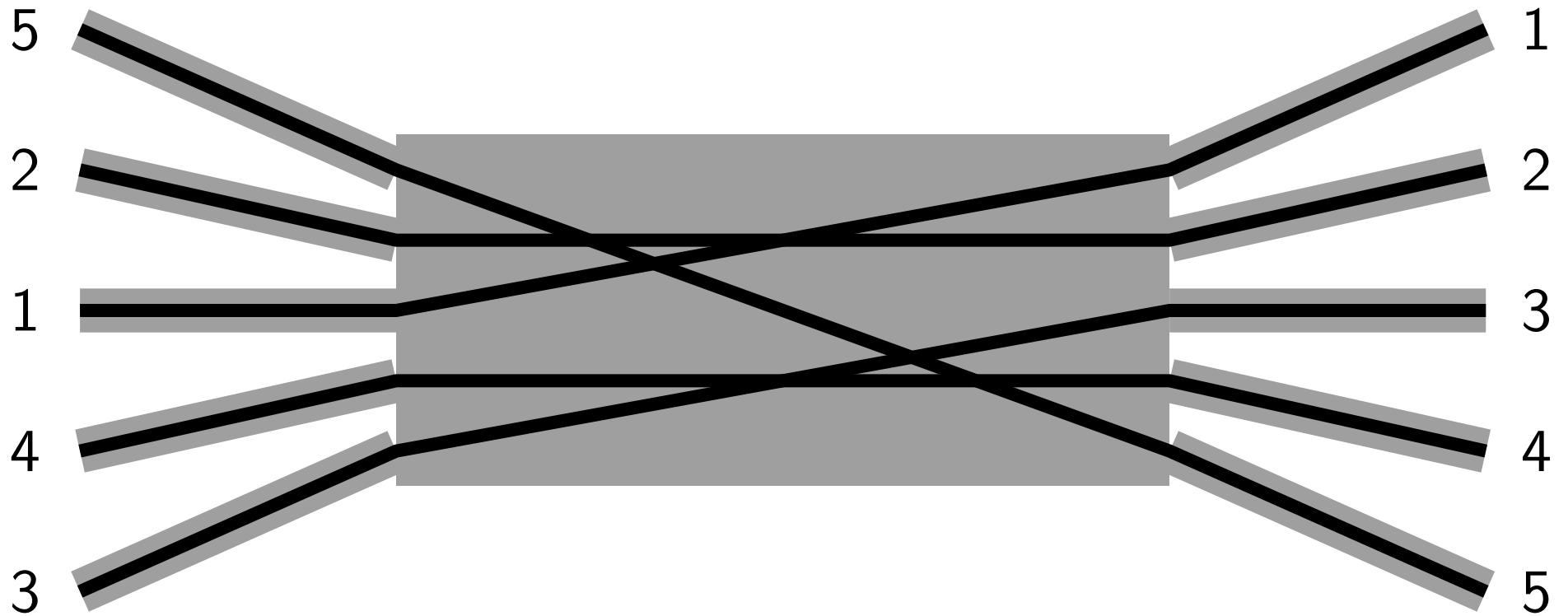

Blockkreuzungen auf einer Kante

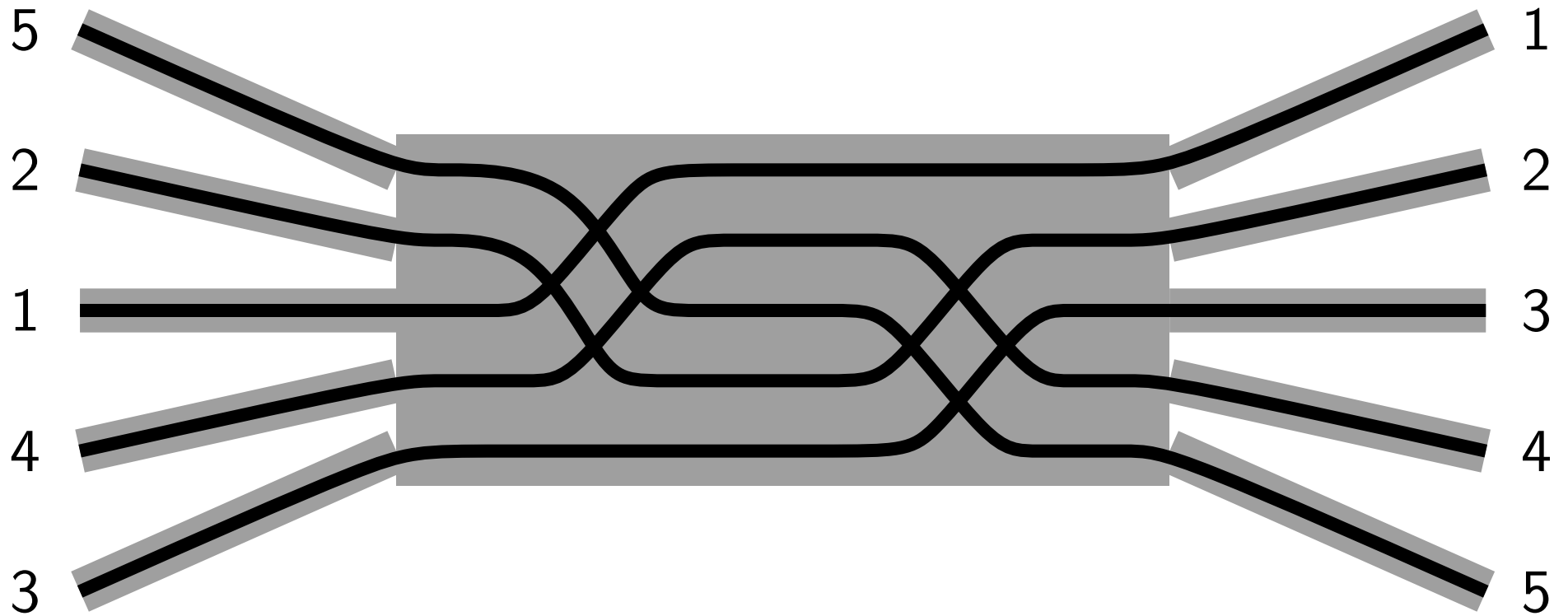

Blockkreuzungen auf einer Kante

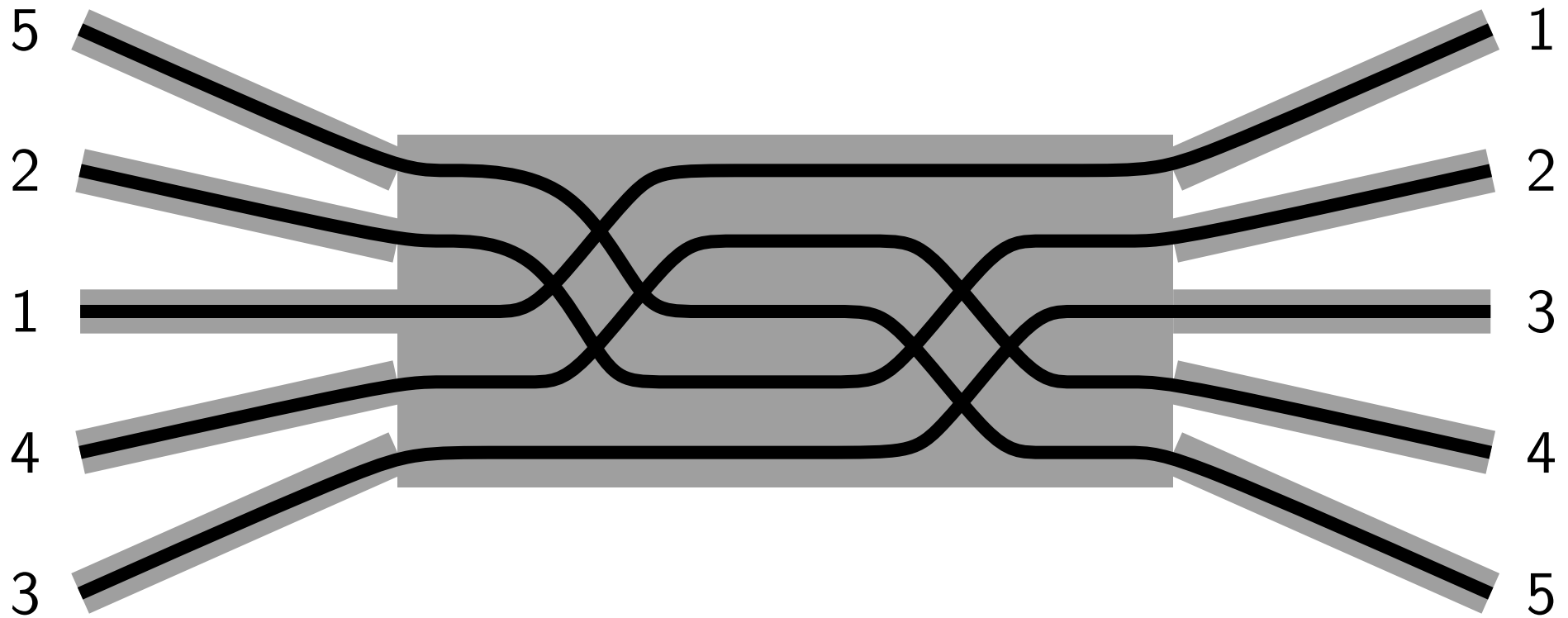

- Entspricht Sortierproblem *Sorting by Transpositions*.

Blockkreuzungen auf einer Kante

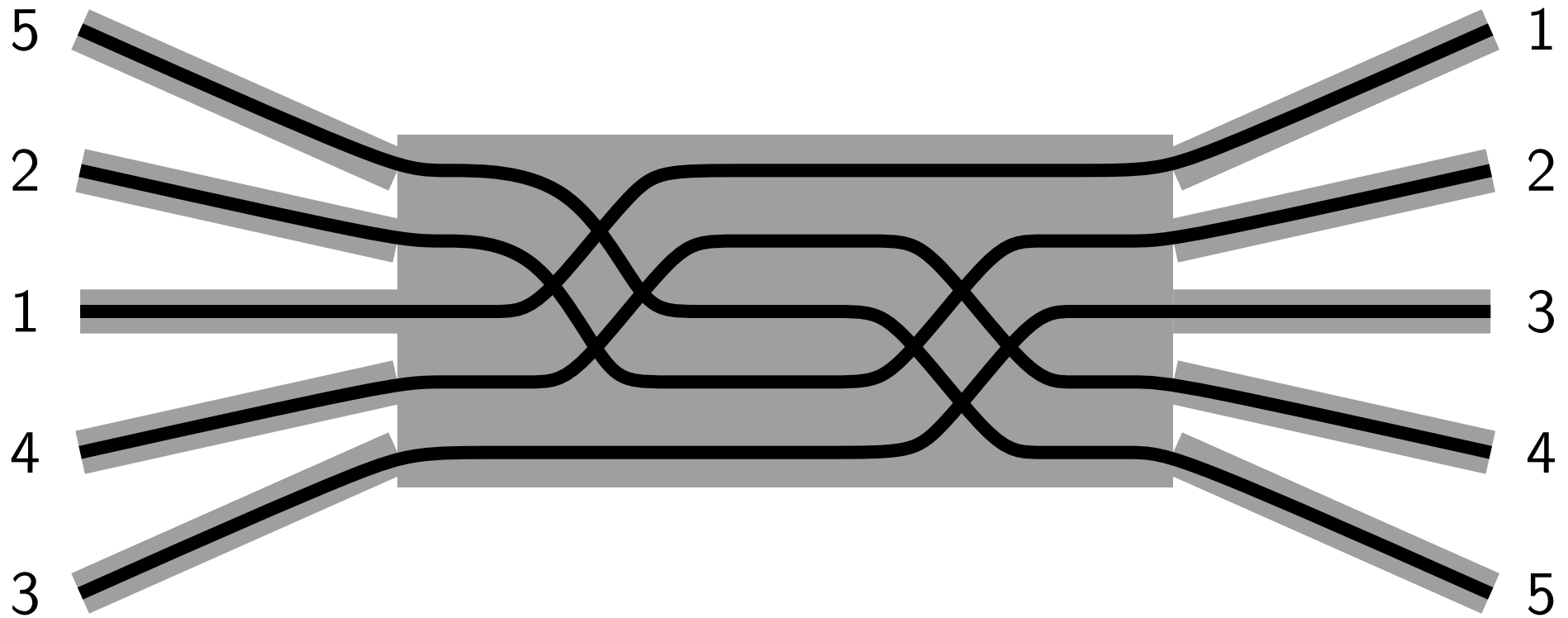

● Entspricht Sortierproblem *Sorting by Transpositions*.

● NP-schwer

[Bulteau et al., 2012]

Blockkreuzungen auf einer Kante

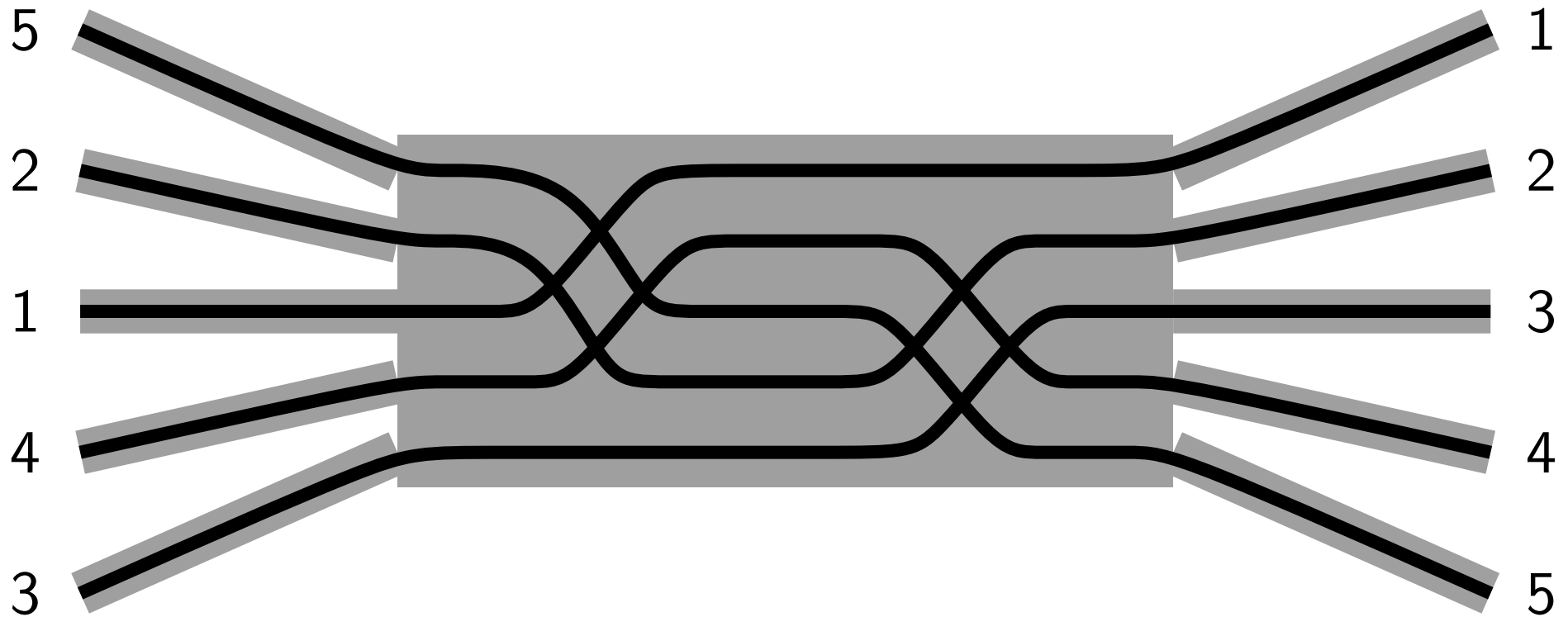

● Entspricht Sortierproblem *Sorting by Transpositions*.

● NP-schwer

[Bulteau et al., 2012]

● einfache 3-Approximation

[Bafna, Pevzner, 1998]

Blockkreuzungen auf einer Kante



● Entspricht Sortierproblem *Sorting by Transpositions*.

● NP-schwer

[Bulteau et al., 2012]

● einfache 3-Approximation

[Bafna, Pevzner, 1998]

Blockkreuzungen auf einer Kante

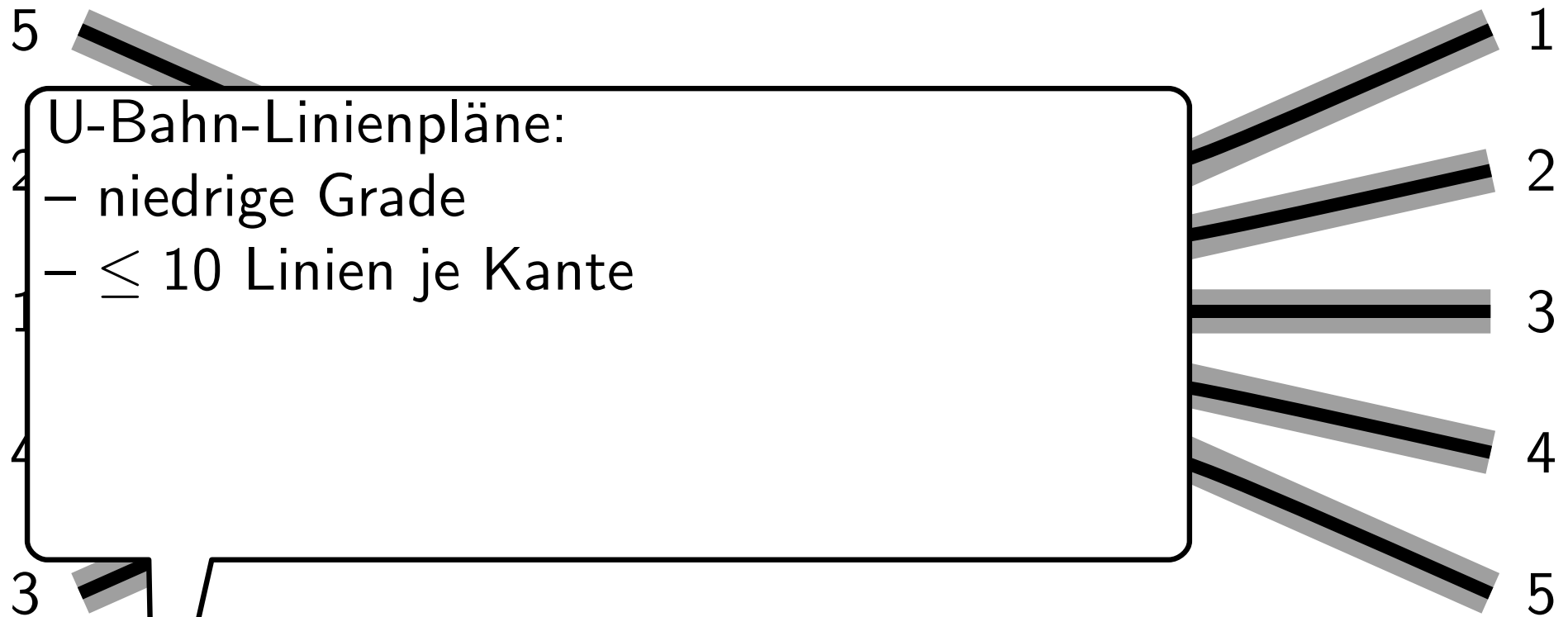

● Entspricht Sortierproblem *Sorting by Transpositions*.

● NP-schwer

[Bulteau et al., 2012]

● einfache 3-Approximation

[Bafna, Pevzner, 1998]

Blockkreuzungen auf einer Kante

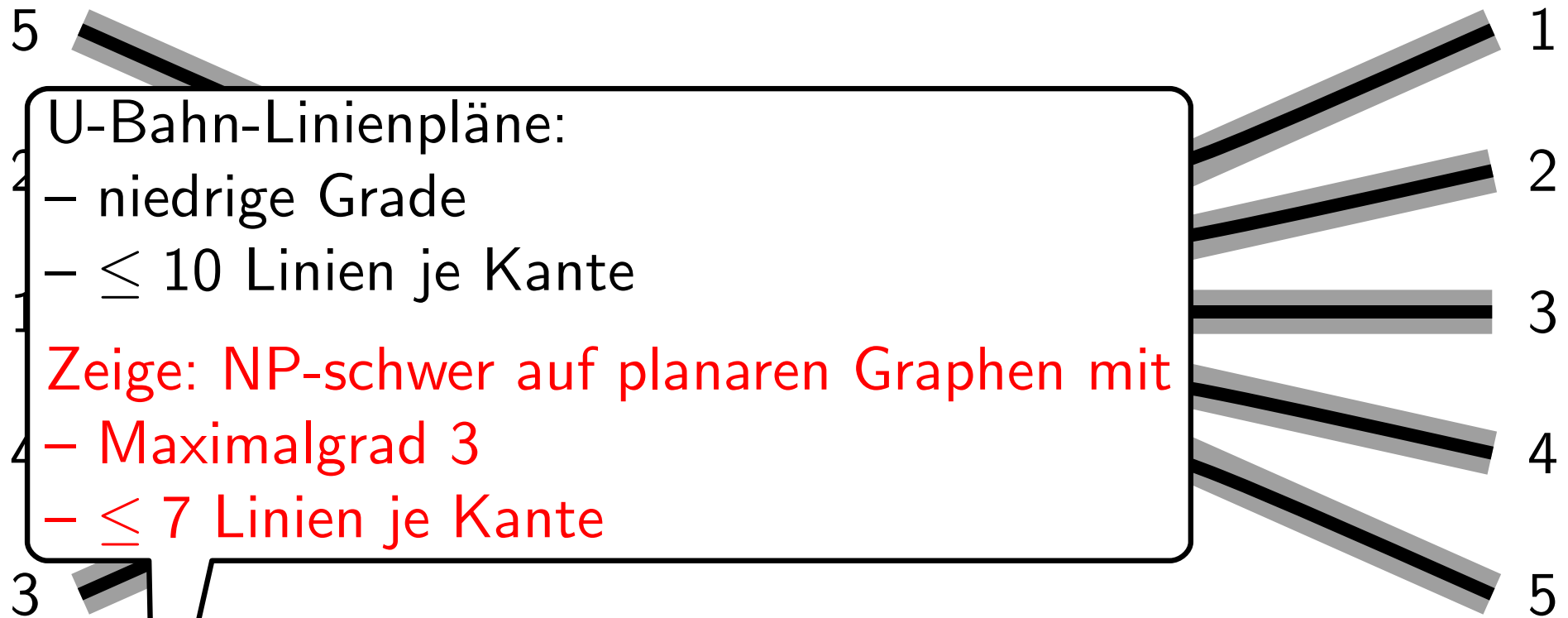

● Entspricht Sortierproblem *Sorting by Transpositions*.

● NP-schwer

[Bulteau et al., 2012]

● einfache 3-Approximation

[Bafna, Pevzner, 1998]

Blockkreuzungen auf allgemeinen Graphen

Idee:

- Löse Kanten iterativ.
- Platziere jeweils alle *nötigen* Kreuzungen.
- Rechtfertige Blockkreuzungen durch *Informationsgewinn*.

Blockkreuzungen auf allgemeinen Graphen

Idee:

- Löse Kanten iterativ.
- Platziere jeweils alle *nötigen* Kreuzungen.
- Rechtfertige Blockkreuzungen durch *Informationsgewinn*.

Genauer:

- $(bc(e))^2 \leq I(e)$

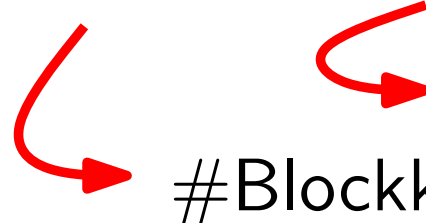
 $bc(e)$ → #Blockkreuzungen auf Kante e

$I(e)$ → Informationsgewinn = #neue Paare von Linien

Blockkreuzungen auf allgemeinen Graphen

Idee:

- Löse Kanten iterativ.
- Platziere jeweils alle *nötigen* Kreuzungen.
- Rechtfertige Blockkreuzungen durch *Informationsgewinn*.

Genauer:

- $(bc(e))^2 \leq I(e)$

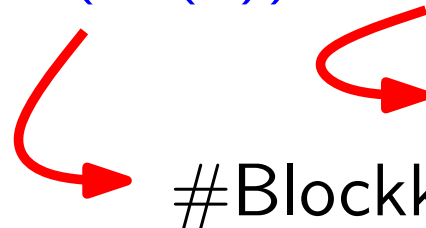
 Informationsgewinn = #neue Paare von Linien
#Blockkreuzungen auf Kante e

- Zum Schluss: $\sum_{e \in E} (bc(e))^2 \leq |L|^2$

- Mit Cauchy-Schwarz: $\sum_{e \in E} bc(e) \leq |L| \sqrt{|E|}$

Blockkreuzungen auf allgemeinen Graphen

Idee:

- Löse Kanten iterativ.
- Platziere jeweils alle *nötigen* Kreuzungen.
- Rechtfertige Blockkreuzungen durch *Informationsgewinn*.

Genauer:

- $(bc(e))^2 \leq I(e)$

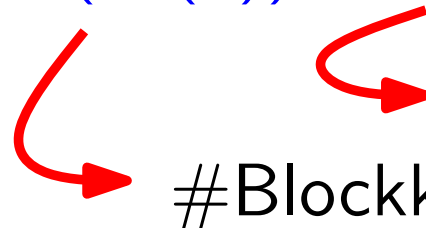
 Informationsgewinn = #neue Paare von Linien
#Blockkreuzungen auf Kante e

- Zum Schluss: $\sum_{e \in E} (bc(e))^2 \leq |L|^2$

- Mit Cauchy-Schwarz: $\sum_{e \in E} bc(e) \leq |L| \sqrt{|E|}$

- es ex. Instanzen: $\Omega(|L| \sqrt{|E|})$ Blockkreuzungen nötig

Teil II:

Punkt mengen-Einbettbarkeit

Punkt mengen-Einbettbarkeit

Graph

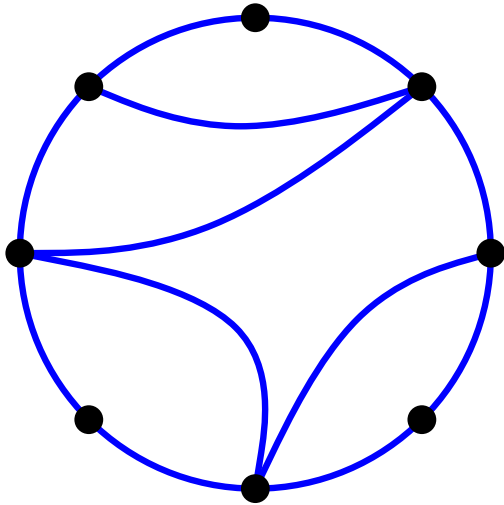

Punktmenge-Einbettbarkeit

Graph

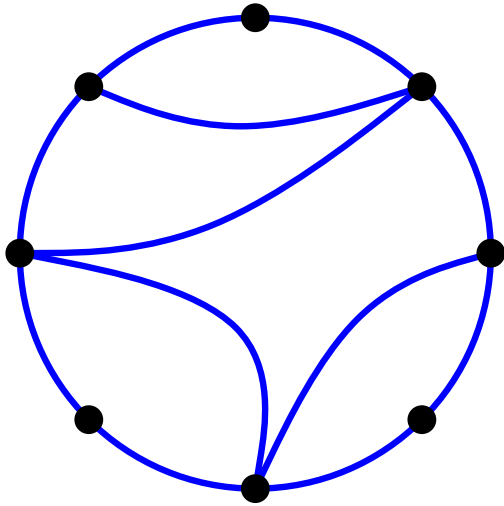

Punktmenge

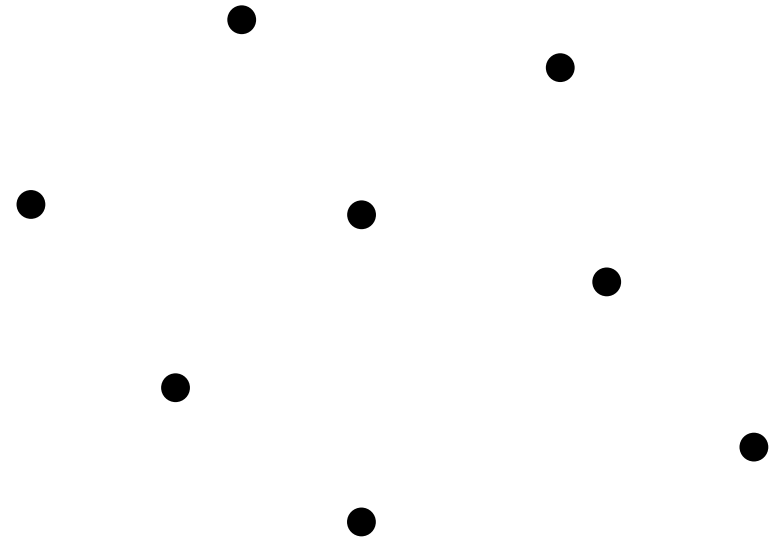

Punktmenge-Einbettbarkeit

Graph

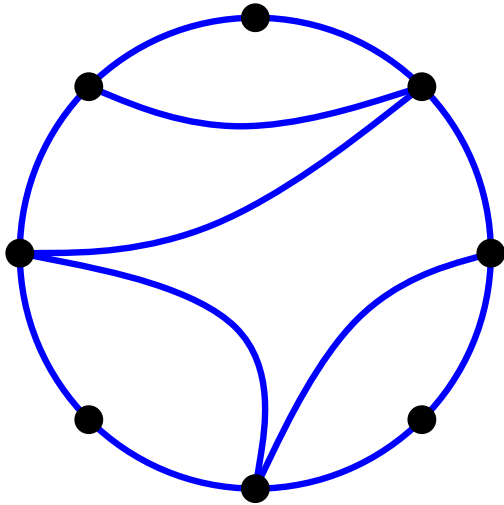

Punktmenge

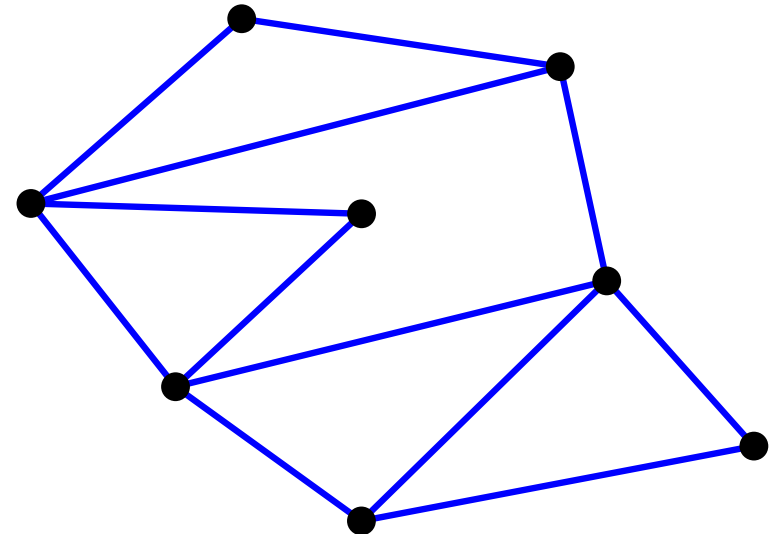

Punktmenge-Einbettbarkeit

Graph

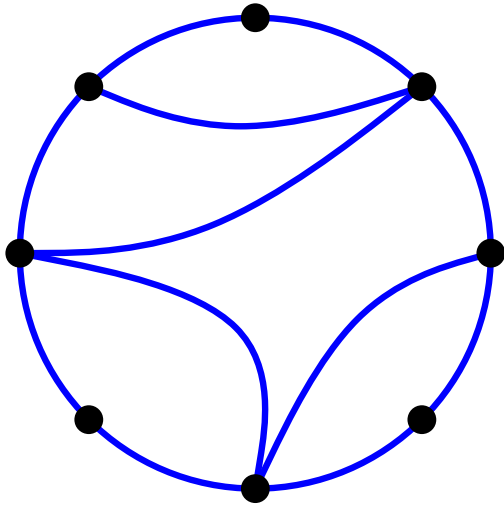

finde
→
Einbettung

Punktmenge

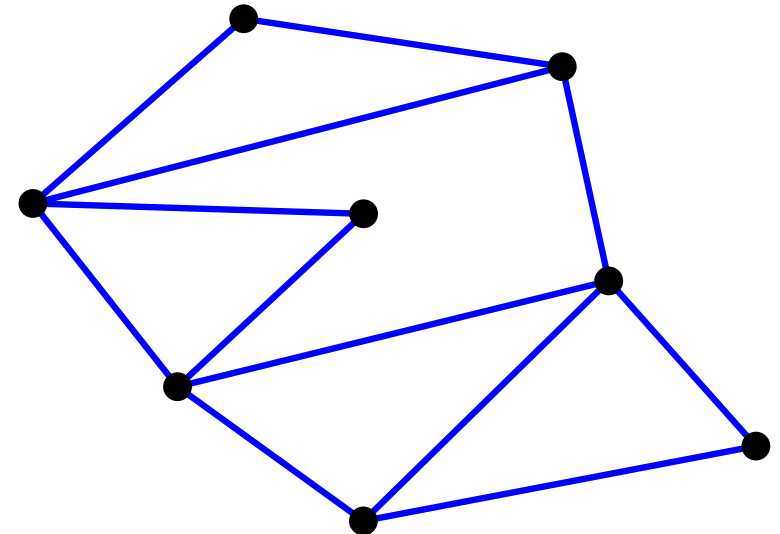

Punktmenge-Einbettbarkeit

Graph

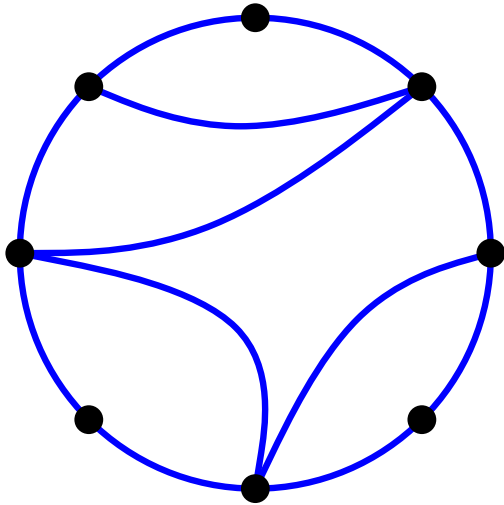

finde
→
Einbettung

Punktmenge

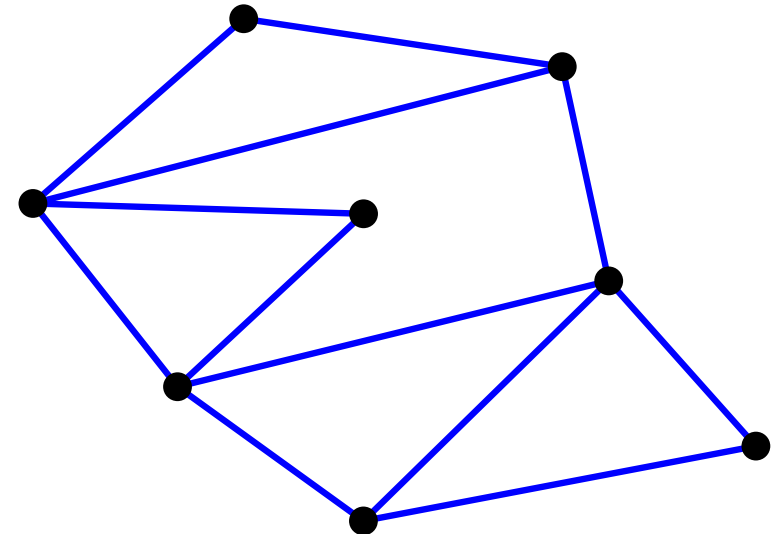

planar, geradlinig: NP-schwer [Cabello, 2006]

Punktmengen-Einbettbarkeit

Graph

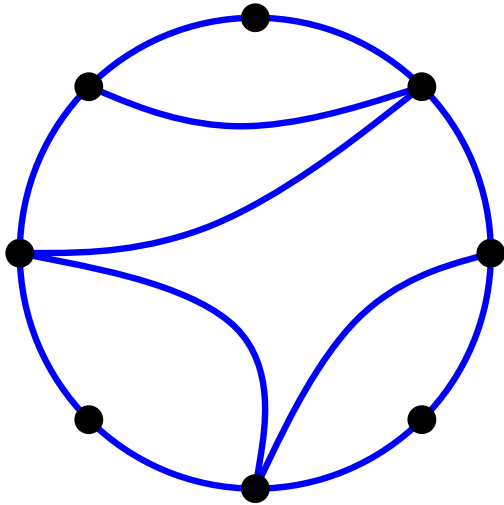

finde
→
Einbettung

Punktemenge

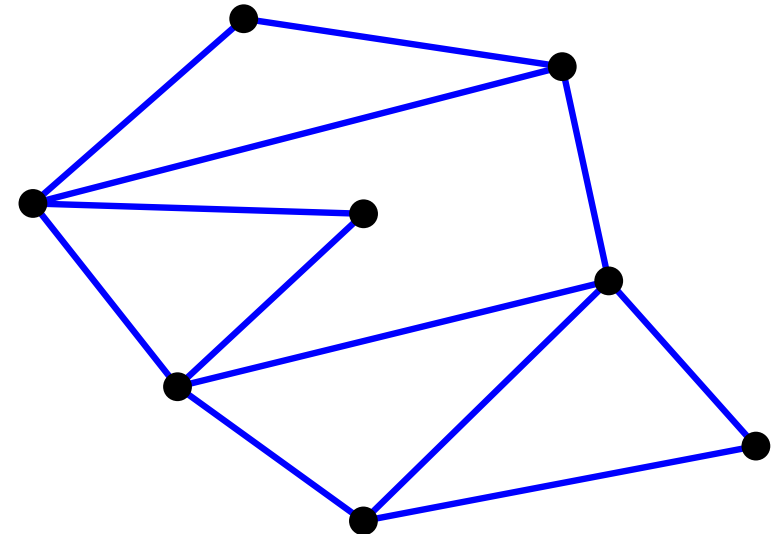

planar, geradlinig: NP-schwer [Cabello, 2006]

untersucht:

- große Kreuzungswinkel
- orthogonaler Stil

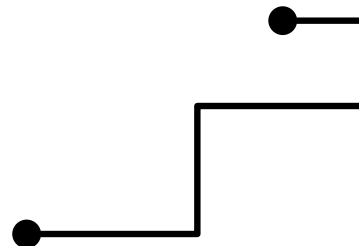

Teil III: Randbeschriftungen

Aufgabe: Beschriftung von Landkarten

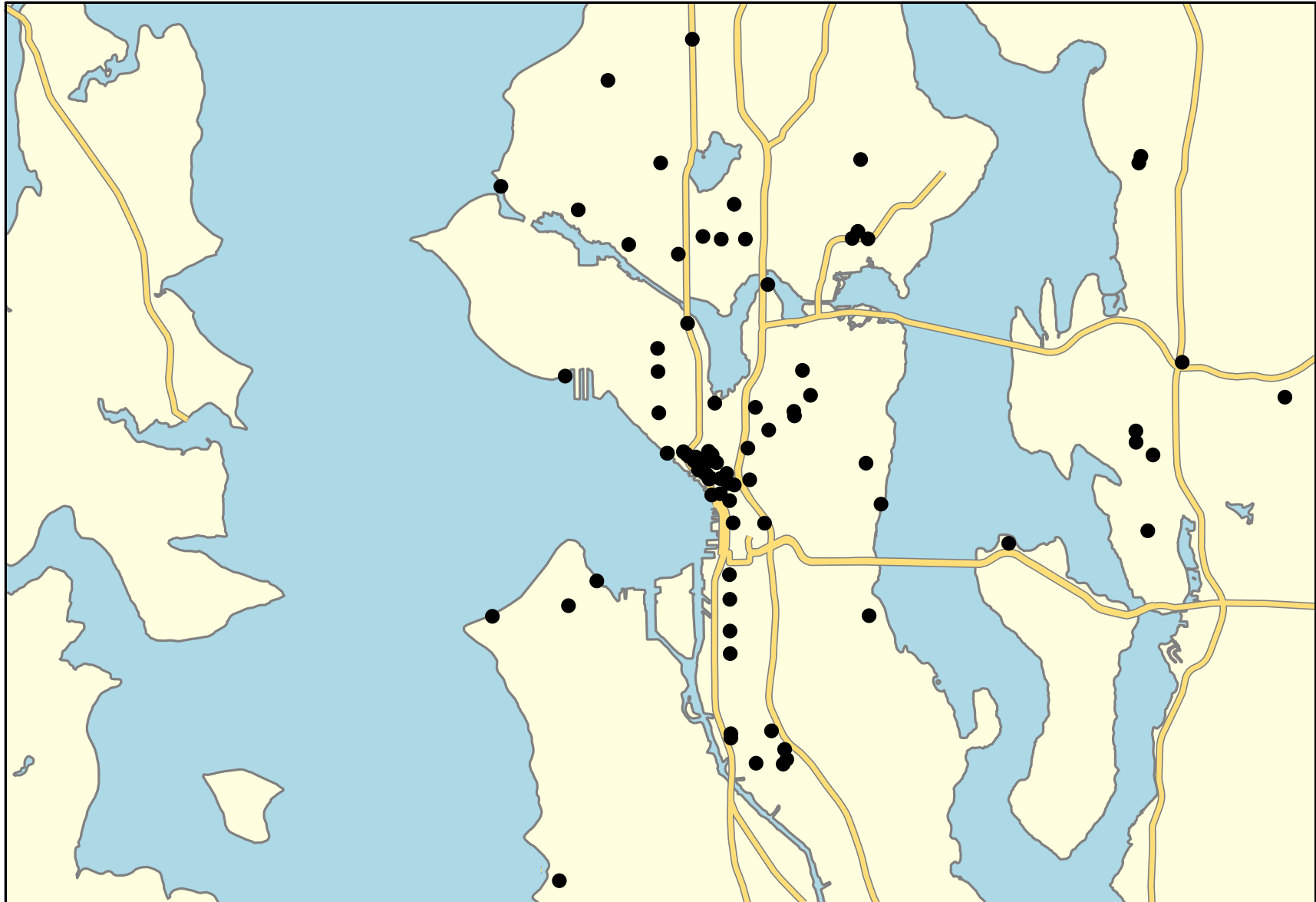

Aufgabe: Beschriftung von Landkarten

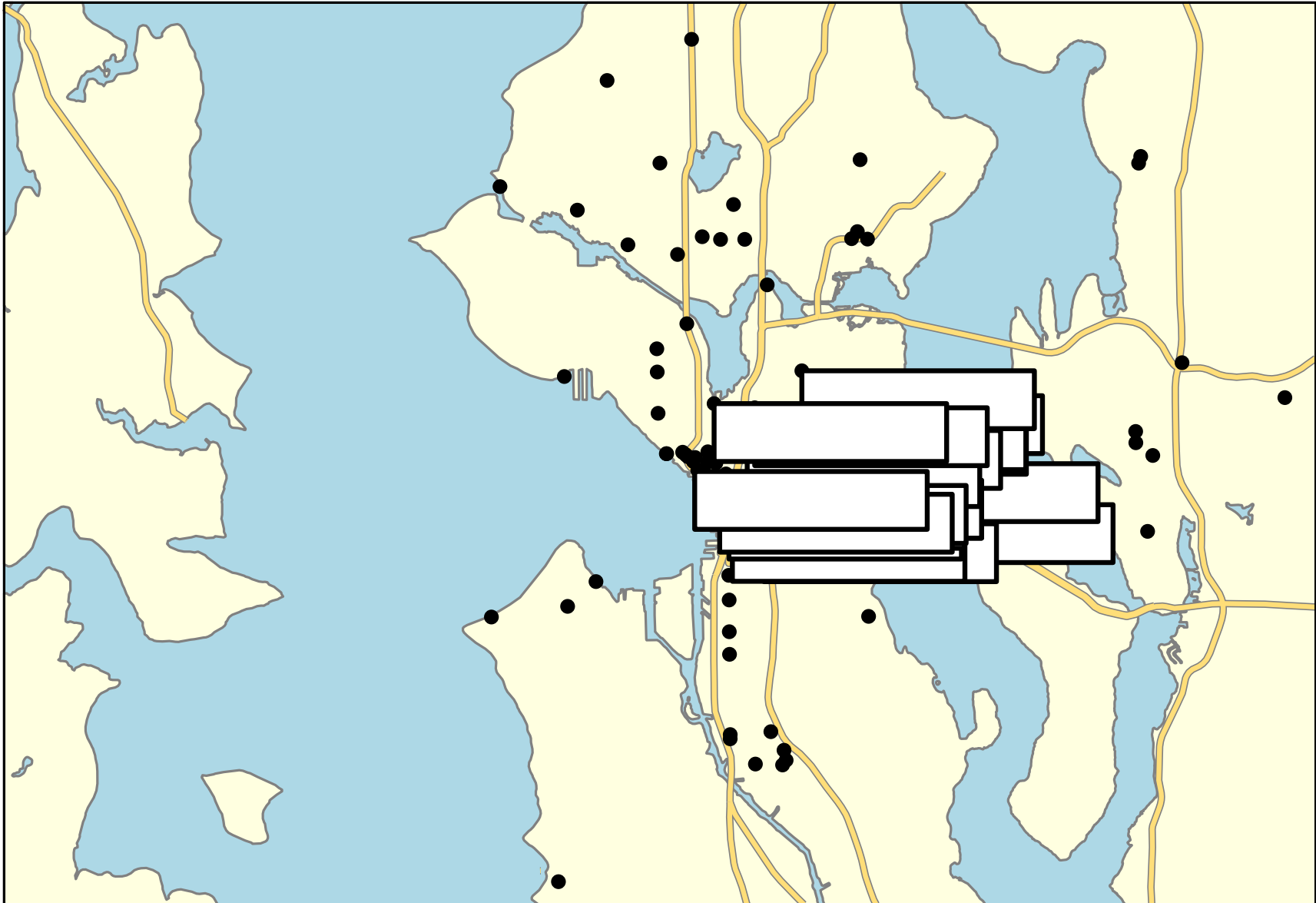

Aufgabe: Beschriftung von Landkarten

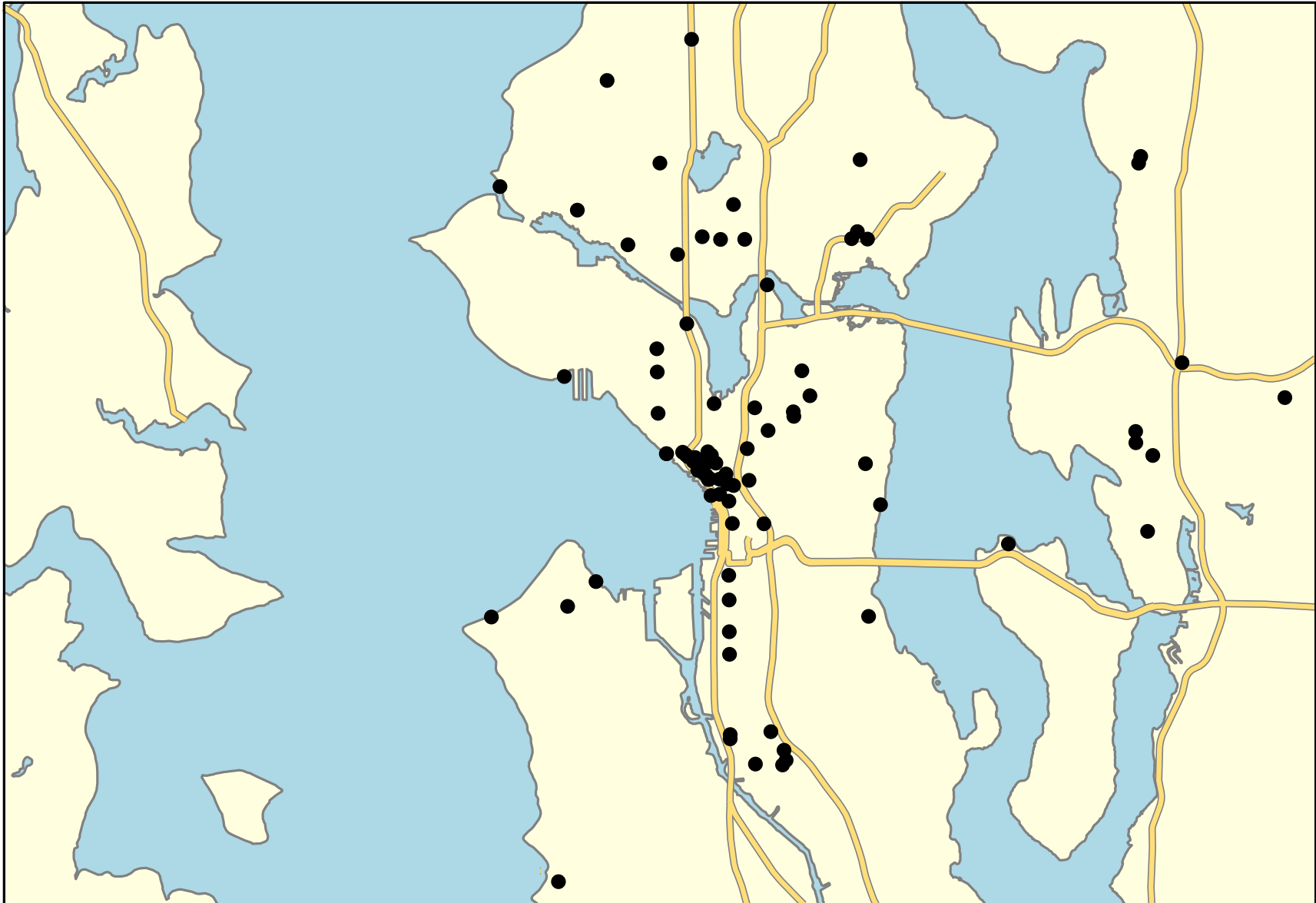

Aufgabe: Beschriftung von Landkarten

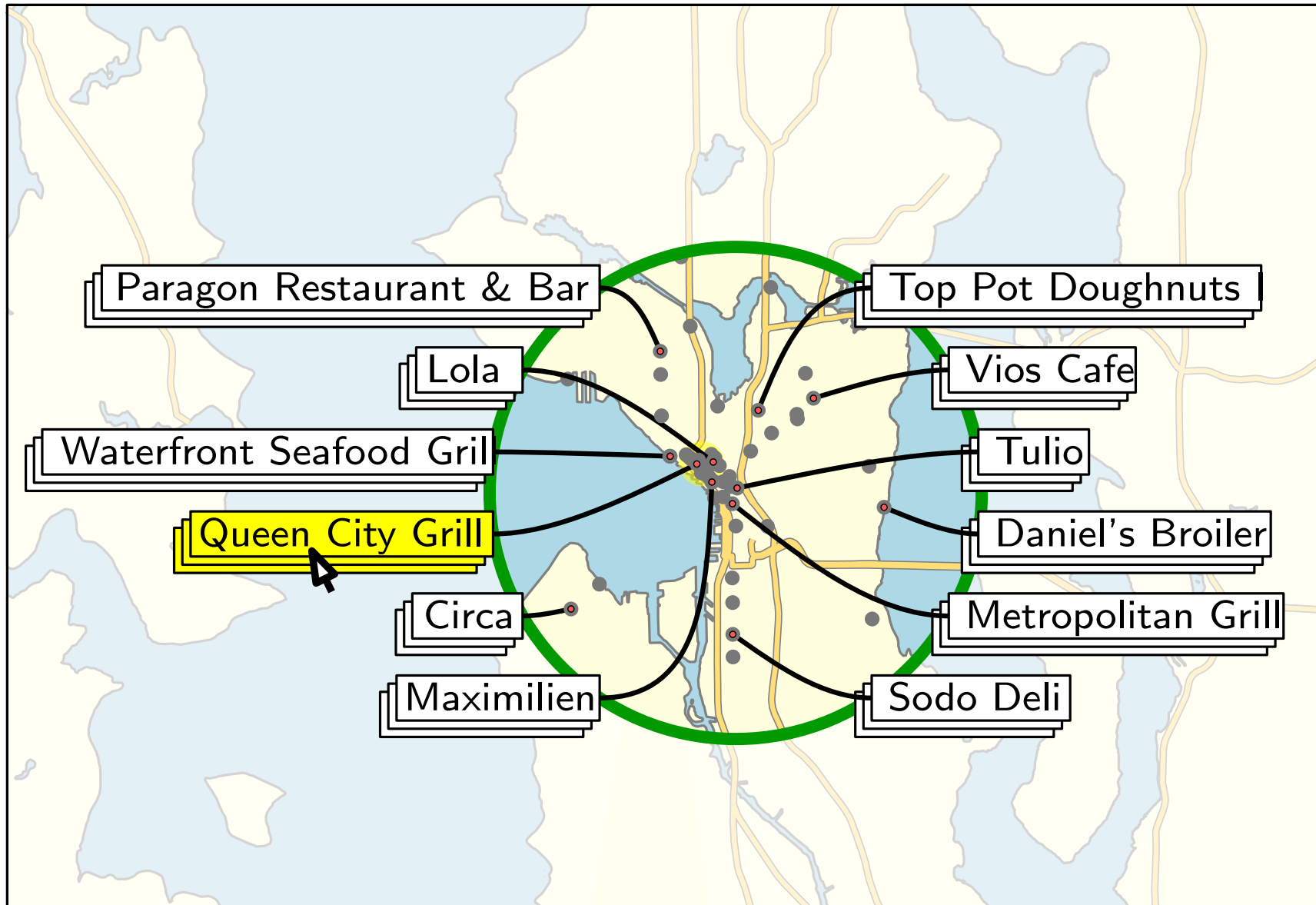

Aufgabe: Beschriftung von Landkarten

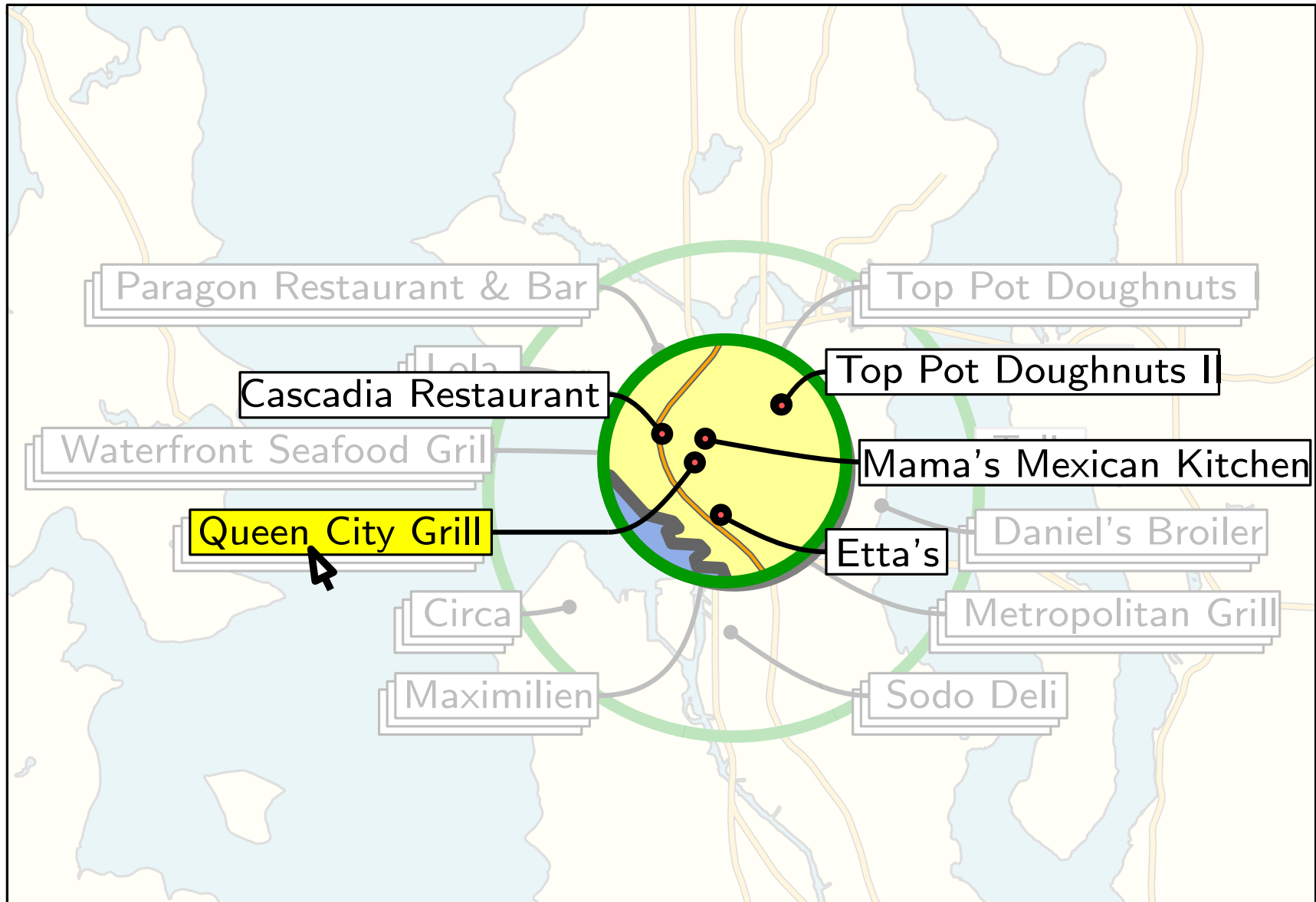

Aufgabe: Beschriftung von Landkarten

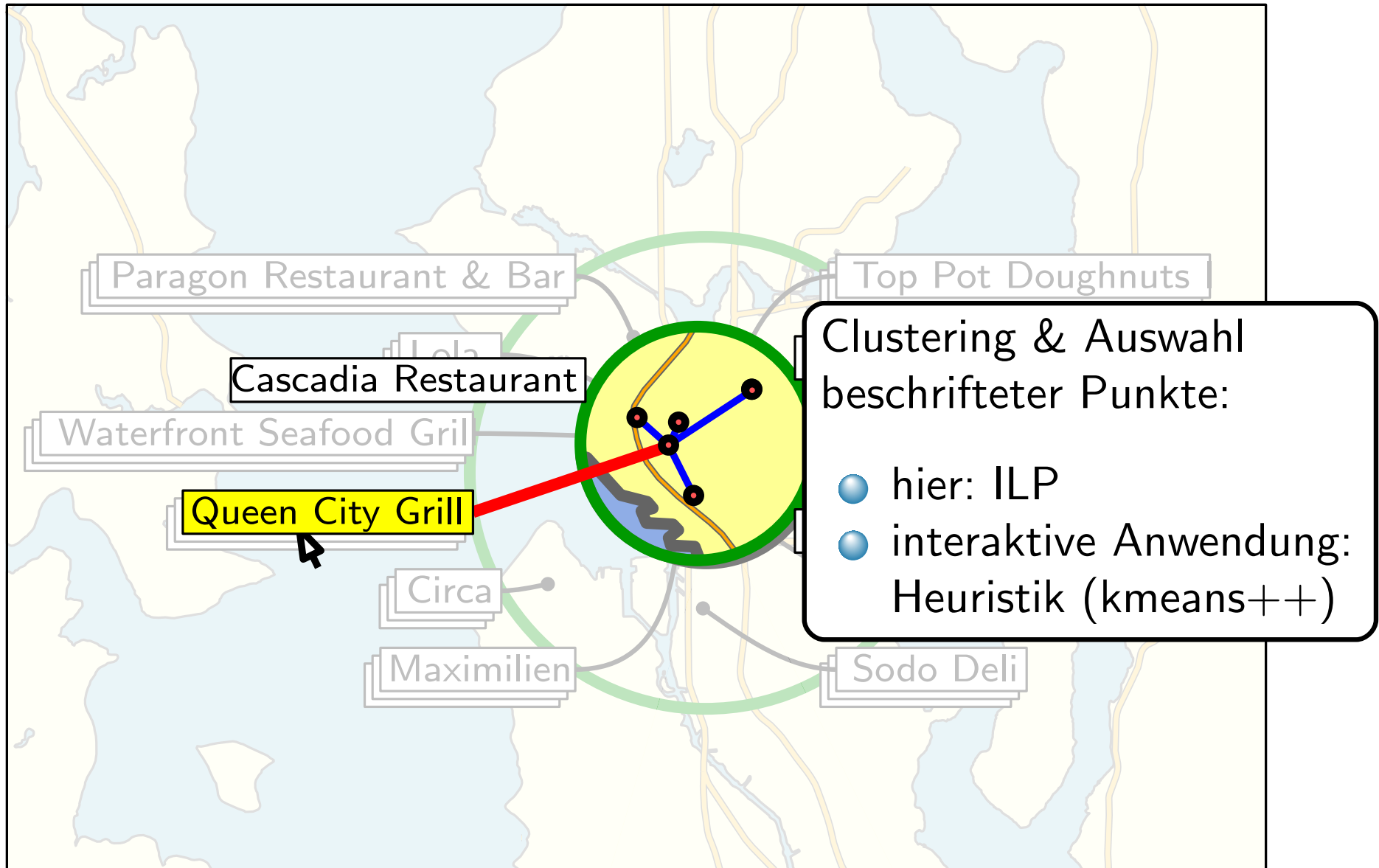

Aufgabe: Beschriftung von Landkarten

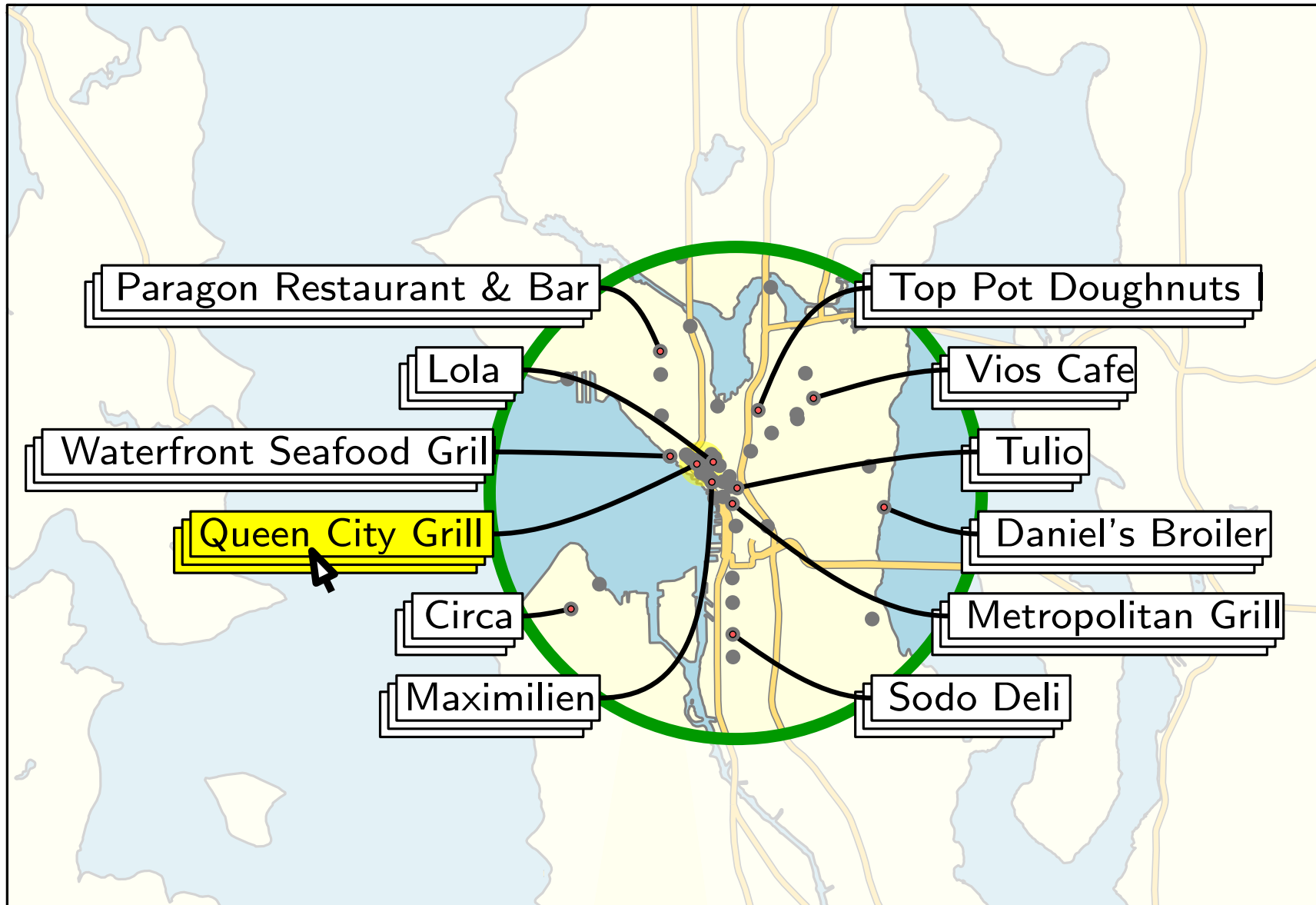

Aufgabe: Beschriftung von Landkarten

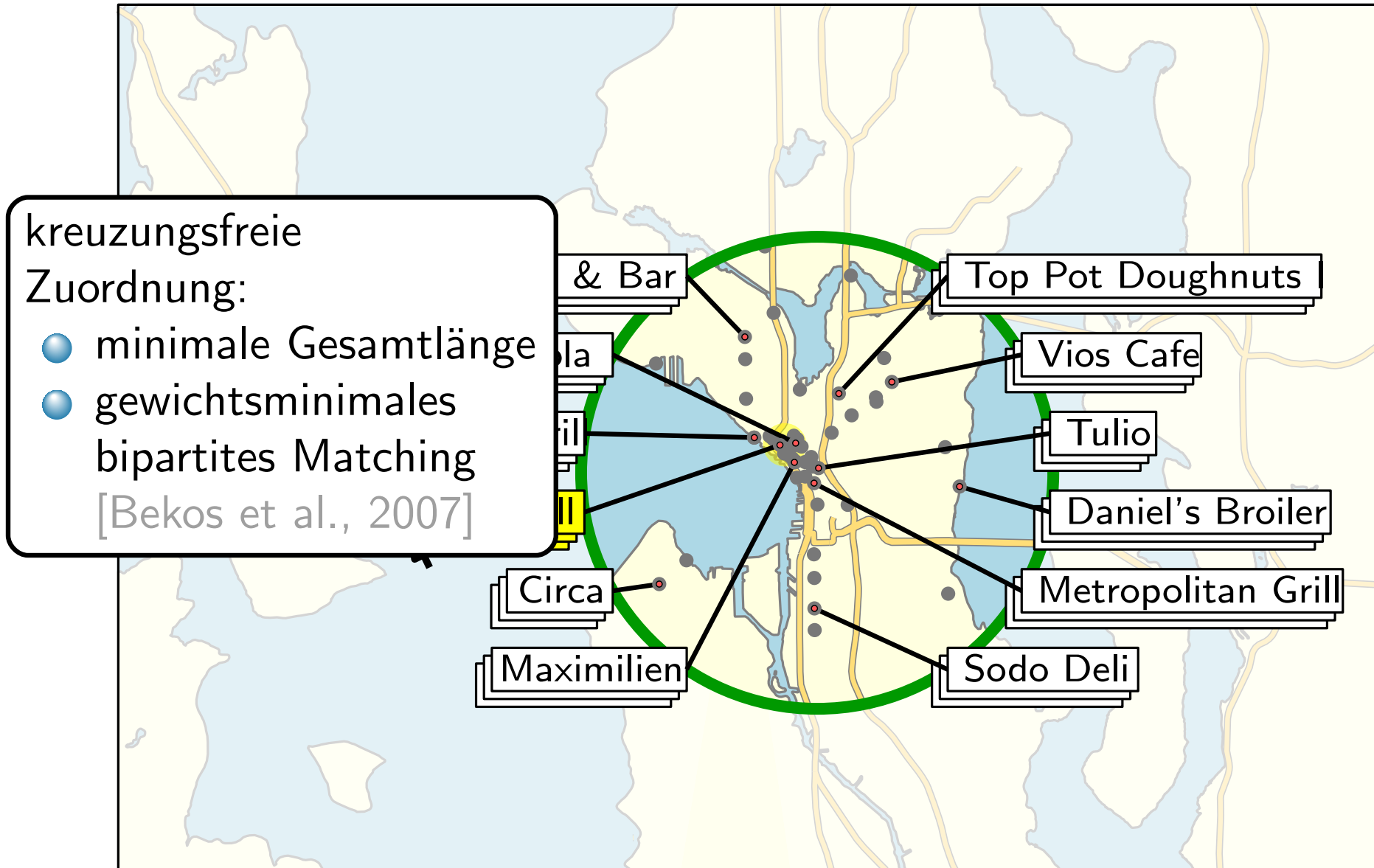

Aufgabe: Beschriftung von Landkarten

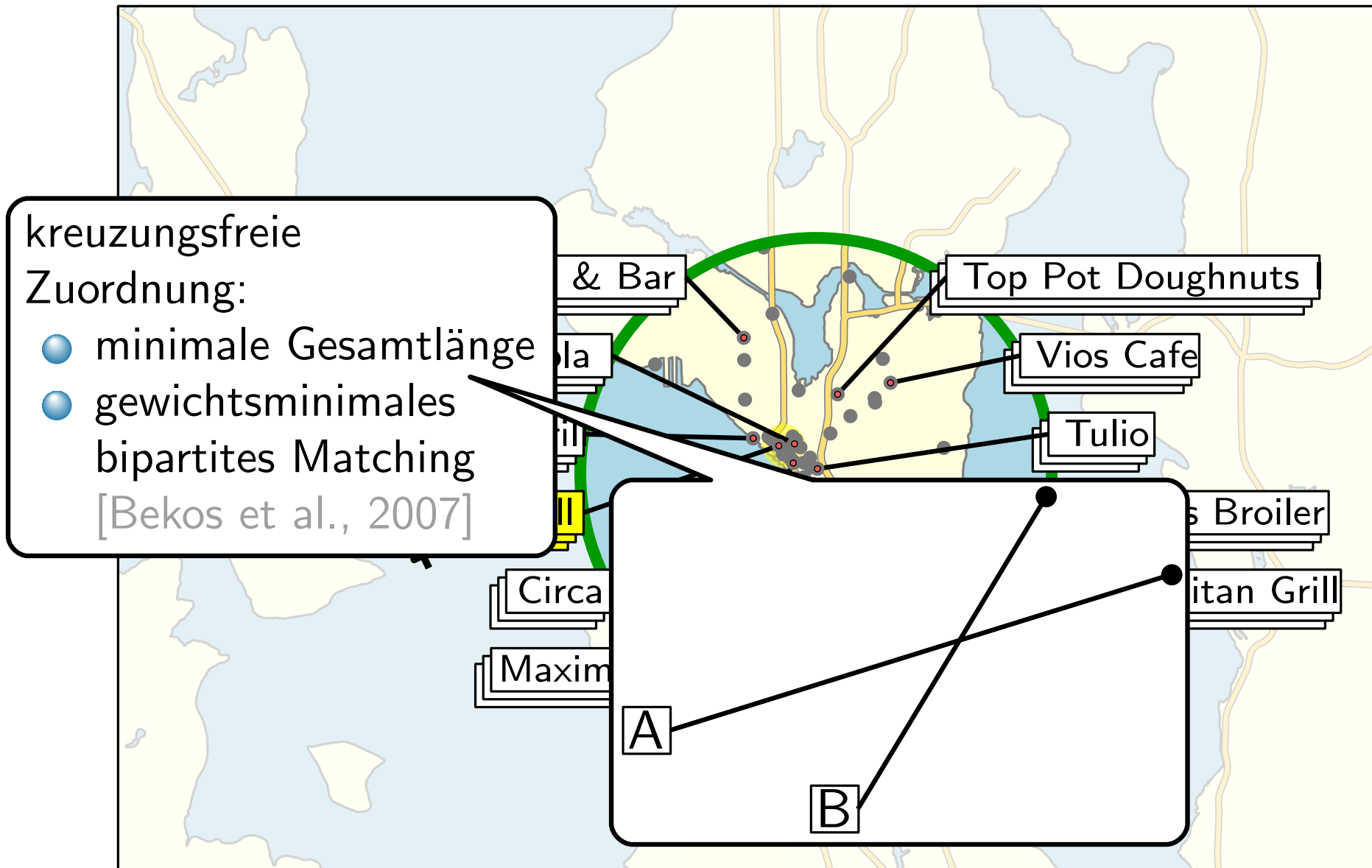

Aufgabe: Beschriftung von Landkarten

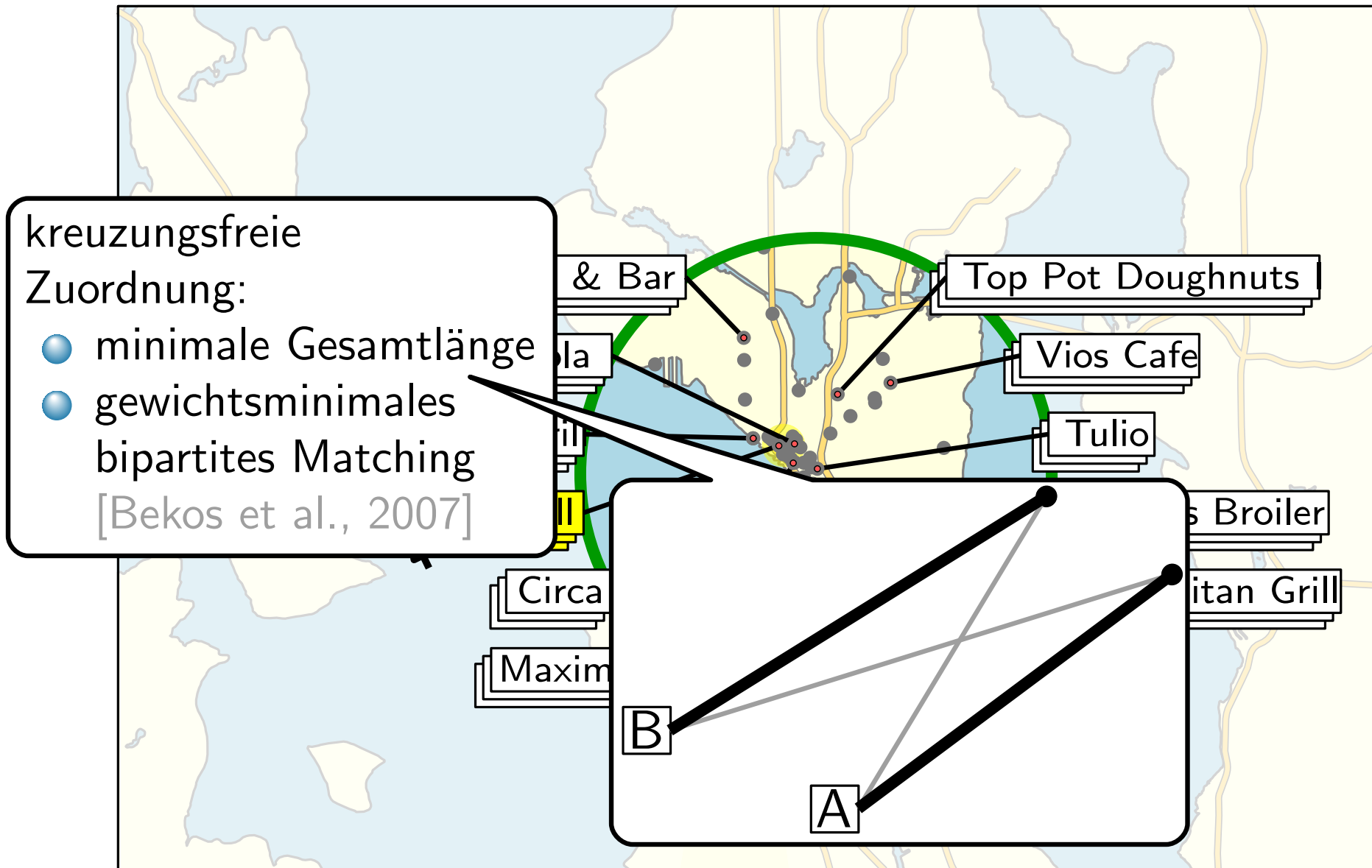

Aufgabe: Beschriftung von Landkarten

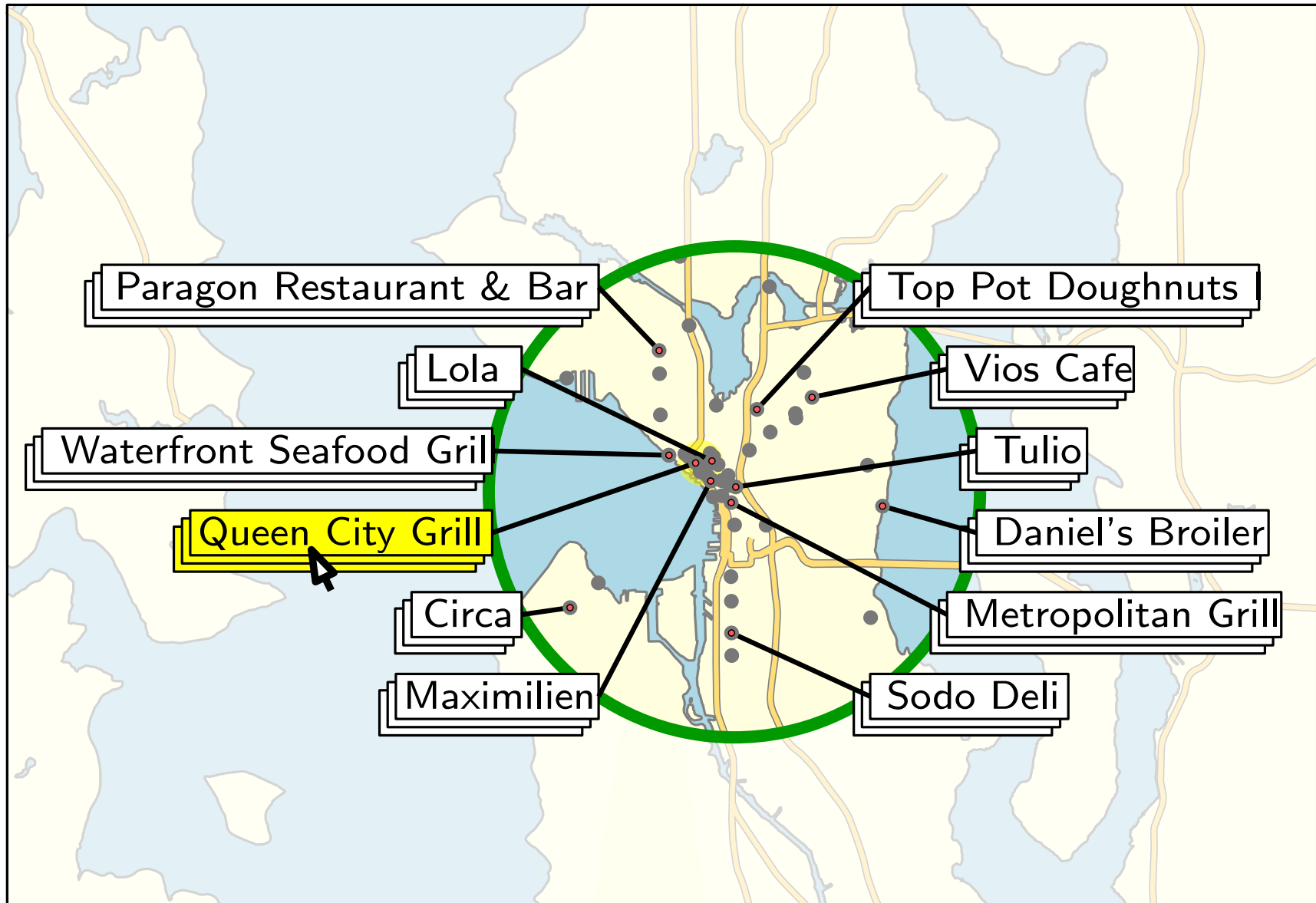

Aufgabe: Beschriftung von Landkarten

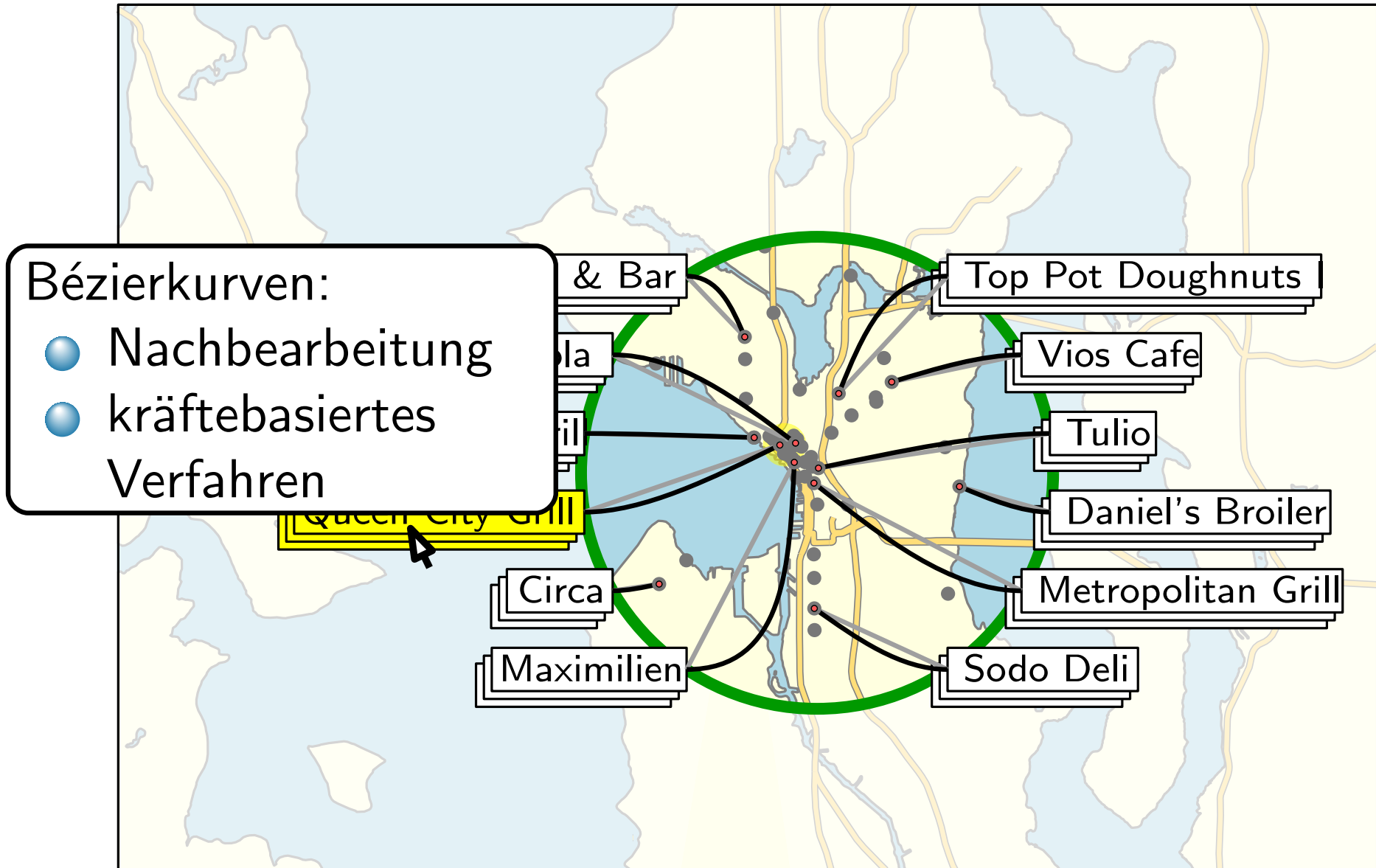

Radiale Beschriftungen

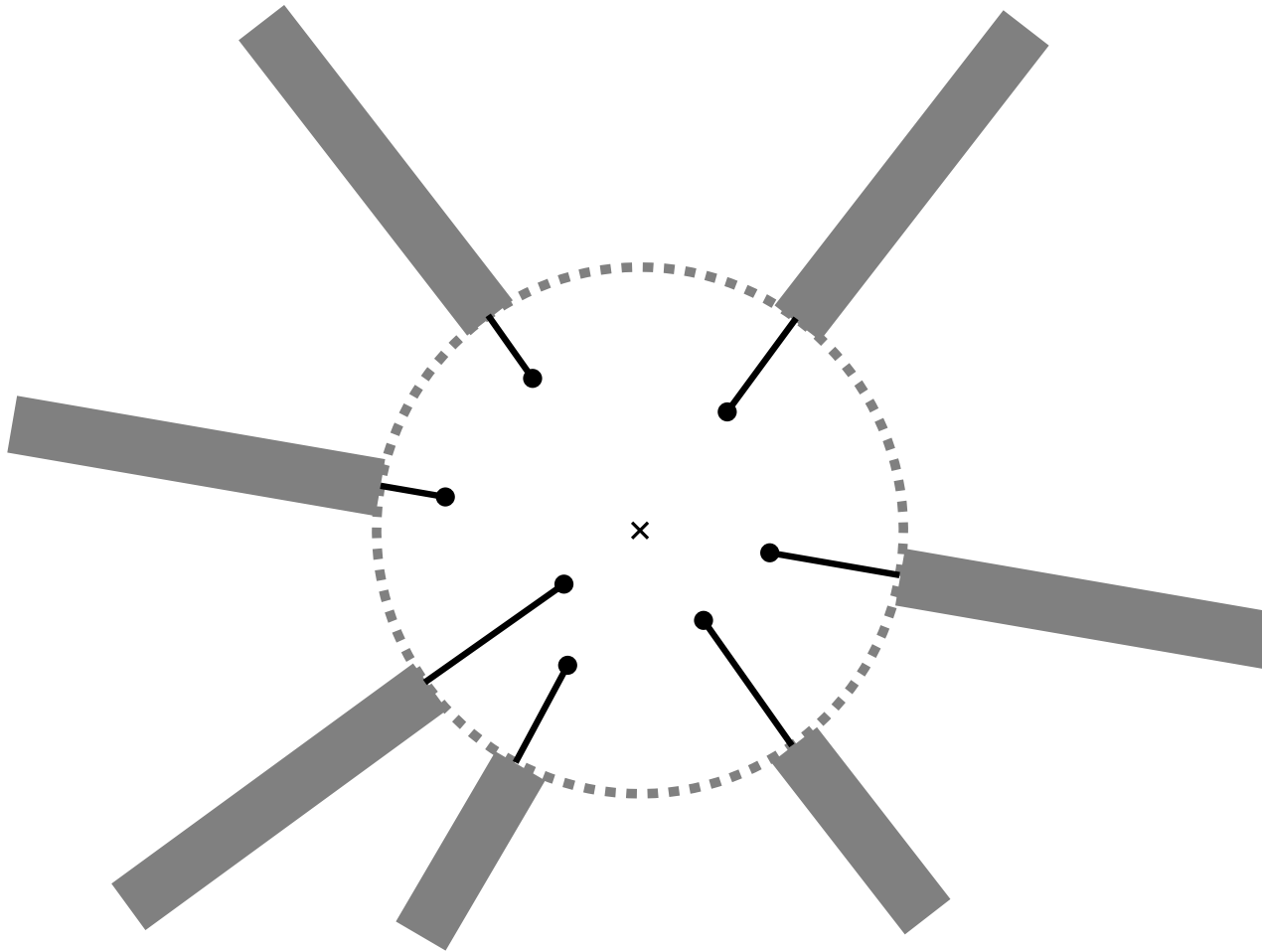

Mehrfachbeschriftungen

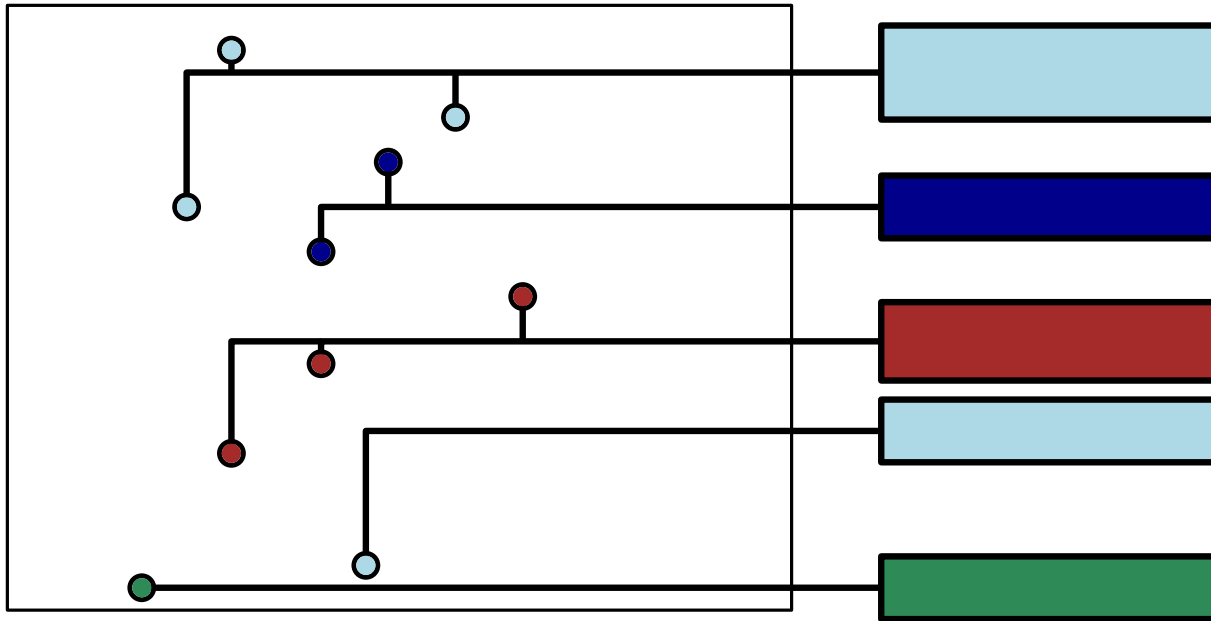

Beschriftung nach
Kategorien

Zusammenfassung

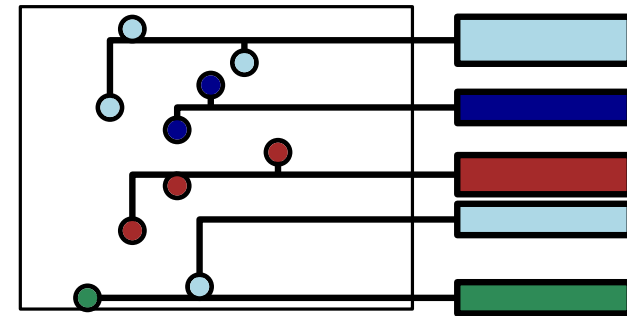
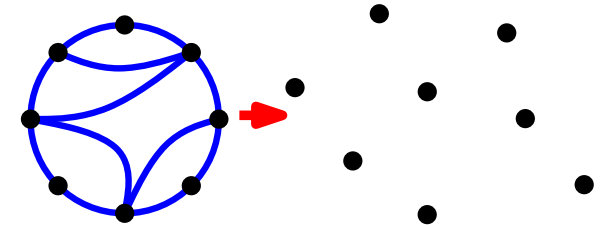
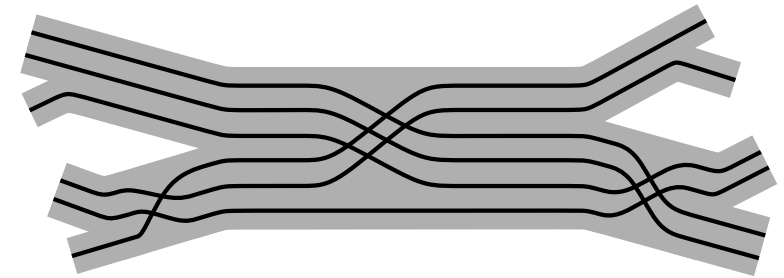
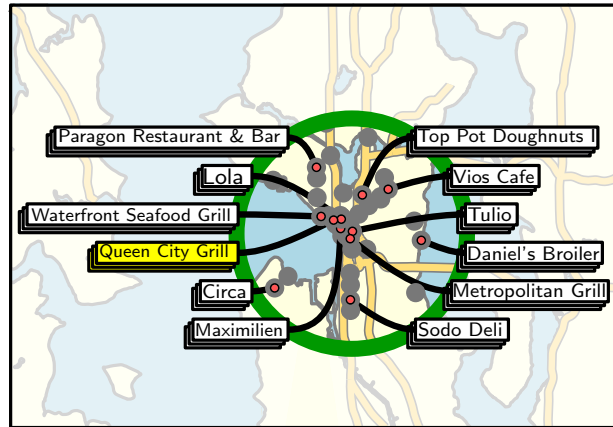
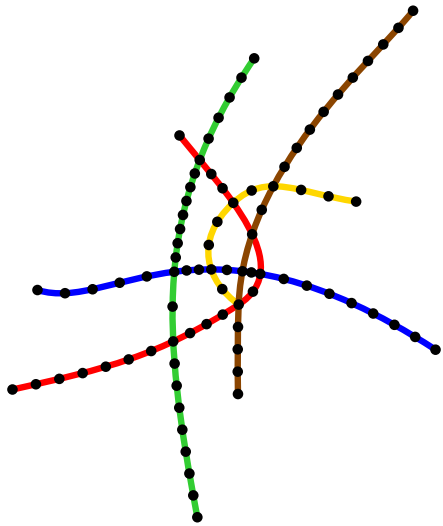

← experimentell

→ theoretisch